

**THE UNITED REPUBLIC OF  
TANZANIA**



**MINISTRY OF HEALTH**

**NATIONAL MEDICAL  
STANDARD OPERATING  
PROCEDURES FOR ZONAL  
AND SPECIALISED LEVEL  
HOSPITAL LABORATORY**

**Version 01:2024**

**JANUARY, 2024**

# **NATIONAL MEDICAL STANDARD OPERATING PROCEDURES FOR ZONAL AND SPECIALISED LEVEL HOSPITAL LABORATORY**

**PUBLISHED IN 2024**

©MINISTRY OF HEALTH,  
MAGUFULI GOVERNMENT CITY, AFYA ROAD/STREET, MTUMBA,  
PO Box 743,  
40478 DODOMA, TANZANIA.

LANDLINE: +255 (0)26 232 3267

EMAIL: [ps@afya.go.tz](mailto:ps@afya.go.tz)

WEBSITE: [www.moh.go.tz](http://www.moh.go.tz)

**ISBN: 978-9912-9833-2-8**

Any section(s) or clause(s) within this document, can be used by the Government of Tanzania Departments, implementers and stakeholders, provided that, the Ministry of Health is acknowledged

## Disclaimer

This document is provided on the basis that it is for the use of MoH and PO RALG only. MoH will not be bound to discuss, explain or reply to queries raised by any agency/organisation other than the intended recipients of this document. MoH disclaims all liability to any third party who may place reliance on this document and therefore does not assume responsibility for any loss or damage suffered by any such third party in reliance thereon.

The images and related drawings used in this document are intended solely as a guiding support and should be considered as purely indicative, not restrictive of the expected item characteristics nor an indication of the client's choice and/or preference.

The views expressed in this manual are those of the individual contributors. Comments on the usefulness of this manual, and suggestions for improvements in future editions will be welcome, and should be addressed to the contact therein.

This communication may contain information that is proprietary, confidential, or exempt from disclosure. If you are not the intended recipient, please note that any other dissemination, distribution, use or copying of this communication is strictly prohibited. Anyone who receives this document in a message in error should notify the sender immediately by telephone or by return e-mail and delete it from their computer.

# Table of Contents

---

---

<b>ABBREVIATIONS AND ACRONYMS .....</b>	<b>XII</b>
<b>TERMS AND DEFINITIONS.....</b>	<b>XVI</b>
<b>FOREWORD .....</b>	<b>I</b>
<b>ACKNOWLEDGEMENTS .....</b>	<b>I</b>
<b>PROF.TUMAINI J. NAGU .....</b>	<b>I</b>
<b>CHIEF MEDICAL OFFICER.....</b>	<b>I</b>
<b>EXECUTIVE SUMMARY .....</b>	<b>II</b>
<b>SCOPE.....</b>	<b>II</b>
<b>PRIMARY BENEFICIARIES.....</b>	<b>III</b>
<b>SECONDARY BENEFICIARIES .....</b>	<b>III</b>
<b>CHAPTER 1: SAMPLE COLLECTION .....</b>	<b>1</b>
<b>GENERAL CONSIDERATIONS .....</b>	<b>1</b>
<b>CHAPTER 2: PARASITOLOGY.....</b>	<b>29</b>
<b>2.1. PROCEDURE FOR MALARIA RAPID TEST (MRDT).....</b>	<b>29</b>
<b>2.1.1. PURPOSE.....</b>	<b>29</b>
<b>2.1.2. SCOPE.....</b>	<b>29</b>
<b>2.1.3. RESPONSIBILITY.....</b>	<b>29</b>
<b>2.1.4. PRINCIPLE.....</b>	<b>29</b>
<b>2.1.5. SAMPLE REQUIREMENTS .....</b>	<b>29</b>
<b>2.1.6. EQUIPMENT .....</b>	<b>29</b>
<b>2.1.7. MATERIALS .....</b>	<b>29</b>
<b>2.1.8. STORAGE AND STABILITY .....</b>	<b>30</b>
<b>2.1.9. SAFETY.....</b>	<b>30</b>
<b>2.1.10. CALIBRATION .....</b>	<b>30</b>
<b>2.1.11. QUALITY CONTROL.....</b>	<b>30</b>
<b>2.1.12. PROCEDURE STEPS .....</b>	<b>30</b>
<b>2.1.13. BIOLOGICAL REFERENCE INTERVALS.....</b>	<b>30</b>

2.1.14.	INTERPRETATION AND REPORTING OF RESULTS .....	30
2.1.15.	LIMITATIONS OF THE PROCEDURE AND SOURCES OF ERROR .....	31
2.1.16.	PERFORMANCE CHARACTERISTICS .....	31
2.1.17.	SUPPORTING DOCUMENTS.....	31
2.1.18.	REFERENCES .....	31
2.2.	PROCEDURE FOR MALARIA MICROSCOPY.....	32
2.3.	PROCEDURE FOR URINE MICROSCOPY .....	37
2.4.	PROCEDURE FOR STOOL ROUTINE EXAMINATION.....	42
2.5.	PROCEDURE FOR EXAMINATION OF BLOOD FOR MICROFILARIAE.....	46
2.6.	PROCEDURE FOR EXAMINATION OF SKIN FOR MICROFILARIAE.....	50
2.7.	PROCEDURE FOR PERFORMING OCCULT BLOOD .....	53
2.8.	PROCEDURE FOR STOOL ANALYSIS BY FORMAL ETHER CONCENTRATION TECHNIQUE .....	56

**CHAPTER 3: BLOOD TRANSFUSION ..... 60**

3.	PROCEDURE FOR ABO AND RHESUS BLOOD GROUPING .....	60
3.1.	PURPOSE.....	60
3.2.	SCOPE .....	60
3.3.	RESPONSIBILITY .....	60
3.4.	PRINCIPLE.....	60
3.5.	SAMPLE REQUIREMENTS .....	60
3.6.	EQUIPMENT .....	60
3.7.	MATERIALS.....	60
3.8.	STORAGE AND STABILITY .....	61
3.9.	SAFETY .....	61
3.10.	CALIBRATION.....	61
3.11.	QUALITY CONTROLS .....	61
3.11.1.	CONTROLLING OF ANTI-SERA .....	61
3.11.2.	CONTROLLING OF O SENSITIZED CELLS .....	61
3.11.3.	CONTROLLING OF PHYSIOLOGICAL SALINE.....	62
3.11.4.	COMMON STEP .....	62
3.11.5.	INTERPRETATION OF IQC RESULTS.....	62
3.12.	PROCEDURE STEPS.....	62
3.12.1.	BLOOD GROUPING PROCEDURE .....	63
3.13.	BIOLOGICAL REFERENCE INTERVALS.....	64
3.14.	INTERPRETATION AND REPORTING OF RESULTS .....	64
3.15.	LIMITATIONS OF THE PROCEDURE AND SOURCE OF ERROR .....	64
3.16.	PERFORMANCE CHARACTERISTICS.....	64
3.17.	SUPPORTING DOCUMENTS.....	65
3.18.	REFERENCES .....	65
3.19.	PROCEDURE FOR ESTIMATION OF HEMOGLOBIN BY USING COPPER SULPHATE SOLUTION	66
3.19.1.	PURPOSE .....	66
3.19.2.	SCOPE.....	66
3.19.3.	RESPONSIBILITY.....	66
3.19.4.	PRINCIPLE .....	66
3.19.5.	SAMPLE REQUIREMENTS.....	66
3.19.6.	EQUIPMENT .....	66
3.19.7.	MATERIALS .....	66
3.19.8.	PREPARATION OF COPPER II SULPHATE SOLUTION.....	66
3.19.9.	PREPARE WORKING SOLUTION .....	67

3.19.10.	STORAGE AND STABILITY .....	67
3.19.11.	SAFETY.....	67
3.19.12.	CALIBRATION .....	67
3.19.13.	QUALITY CONTROL.....	67
3.19.14.	PROCEDURE STEPS .....	67
3.19.15.	BIOLOGICAL REFERENCE INTERVALS .....	68
3.19.16.	INTERPRETATION AND REPORTING OF RESULTS .....	68
3.19.17.	LIMITATIONS OF THE PROCEDURE AND SOURCES OF ERROR.....	68
3.19.18.	PERFORMANCE CHARACTERISTICS .....	68
3.19.19.	SUPPORTING DOCUMENTS .....	69
3.19.20.	REFERENCES .....	69
3.20.	PROCEDURE FOR COMPATIBILITY TESTING .....	70
3.20.1.	. PURPOSE .....	70
3.20.2.	SCOPE.....	70
3.20.3.	RESPONSIBILITY.....	70
3.20.4.	PRINCIPLE .....	70
3.20.5.	SAMPLE REQUIREMENTS.....	70
3.20.6.	EQUIPMENT .....	70
3.20.7.	MATERIALS .....	70
3.20.8.	STORAGE AND STABILITY .....	71
3.20.9.	SAFETY.....	71
3.20.10.	CALIBRATION .....	71
3.20.11.	QUALITY CONTROL .....	71
3.20.12.	PROCEDURE STEPS .....	71
3.20.13.	BIOLOGICAL REFERENCES INTERVALS.....	72
3.20.14.	REPORTING AND INTERPRETATION OF RESULTS .....	72
3.20.15.	LIMITATION OF THE PROCEDURE AND SOURCES OF ERRORS .....	72
3.20.16.	PERFORMANCE CHARACTERISTICS .....	72
3.20.17.	SUPPORTING DOCUMENTS .....	72
3.20.18.	REFERENCES .....	72
3.21.	PROCEDURE FOR ABO BLOOD GROUPING DISCREPANCIES .....	73
3.21.1.	PURPOSE .....	73
3.21.2.	SCOPE.....	73
3.21.3.	RESPONSIBILITY.....	73
3.21.4.	PRINCIPLE .....	73
3.21.5.	SAMPLE REQUIREMENTS.....	73
3.21.6.	EQUIPMENT .....	73
3.21.7.	MATERIALS .....	73
3.21.8.	STORAGE AND STABILITY .....	74
3.21.9.	SAFETY.....	74
3.21.10.	CALIBRATION .....	74
3.21.11.	QUALITY CONTROL.....	74
3.21.12.	PROCEDURE.....	74
3.21.13.	BIOLOGICAL REFERENCE INTERVAL .....	74
3.21.14.	REPORTING AND INTERPRETATION OF RESULTS .....	74
3.21.15.	LIMITATION OF THE PROCEDURE AND SOURCES OF ERROR .....	75
3.21.16.	PERFORMANCE CHARACTERISTICS .....	75
3.21.17.	SUPPORTING DOCUMENTS .....	75
3.21.18.	REFERENCES .....	75
3.22.	PROCEDURE FOR DIRECT ANTIGLOBLIN (COOMBS) TEST.....	76

3.22.1.	PURPOSE .....	76
3.22.2.	SCOPE.....	76
3.22.3.	RESPONSIBILITY.....	76
3.22.4.	PRINCIPLE .....	76
3.22.5.	SAMPLE REQUIREMENT .....	76
3.22.6.	EQUIPMENT .....	76
3.22.7.	MAINTENANCE.....	76
3.22.8.	MATERIALS .....	76
3.22.9.	STORAGE AND STABILITY .....	77
3.22.10.	SAFETY.....	77
3.22.11.	CALIBRATION .....	77
3.22.12.	QUALITY CONTROL.....	77
3.22.13.	PROCEDURE.....	78
3.22.14.	PREPARATION OF O SENSITIZED RED CELLS .....	78
3.22.15.	BIOLOGICAL REFERENCE INTERVALS .....	79
3.22.16.	REPORTING AND INTERPRETATION OF RESULTS .....	79
3.22.17.	LIMITATIONS OF THE PROCEDURE AND SOURCES OF ERROR .....	79
3.22.18.	PERFORMANCE CHARACTERISTICS .....	79
3.22.19.	SUPPORTING DOCUMENTS .....	80
3.22.20.	REFERENCES .....	80
3.23.	<b>PROCEDURE FOR INDIRECT ANTIGLOBULIN (COOMBS) TEST.....</b>	<b>81</b>
3.23.1.	PURPOSE .....	81
3.23.2.	SCOPE.....	81
3.23.3.	RESPONSIBILITY.....	81
3.23.4.	PRINCIPLE .....	81
3.23.5.	SAMPLE REQUIREMENTS.....	81
3.23.6.	EQUIPMENT .....	81
3.23.7.	MATERIALS .....	81
3.23.8.	SAFETY CONTROLS.....	82
3.23.9.	BIOLOGICAL REFERENCE INTERVALS.....	83
3.23.10.	REPORTING AND INTERPRETATION OF RESULTS .....	83
3.23.11.	LIMITATION OF THE PROCEDURE AND SOURCES OF ERRORS .....	83
3.23.12.	PERFORMANCE CHARACTERISTICS .....	83
3.23.13.	SUPPORTING DOCUMENTS .....	83
3.23.14.	REFERENCES .....	84
3.24.	<b>PROCEDURE FOR INVESTIGATION OF BLOOD TRANSFUSION REACTIONS .....</b>	<b>85</b>
3.24.1.	PURPOSE .....	85
3.24.2.	SCOPE.....	85
3.24.3.	RESPONSIBILITY.....	85
3.24.4.	PRINCIPLE .....	85
3.24.5.	SAMPLE REQUIREMENT .....	85
3.24.6.	EQUIPMENT .....	85
3.24.7.	MATERIALS .....	85
3.24.8.	STORAGE AND STABILITY .....	85
3.24.9.	SAFETY.....	85
3.24.10.	CALIBRATION .....	86
3.24.11.	QUALITY CONTROLS .....	86
3.24.12.	PROCEDURE STEPS .....	86
3.24.13.	BIOLOGICAL REFERENCE INTERVALS .....	86
3.24.14.	REPORTING OF RESULT AND INTERPRETATION.....	86

3.24.15.	LIMITATIONS OF THE PROCEDURE AND SOURCES OF ERROR.....	86
3.24.16.	PERFORMANCE CHARACTERISTICS .....	87
3.24.17.	SUPPORTING DOCUMENTS .....	87
3.24.18.	REFERENCES .....	87
3.25.	<b>PROCEDURE FOR PREPARATION OF BLOOD PRODUCTS.....</b>	<b>88</b>
3.25.1.	PURPOSE .....	88
3.25.2.	SCOPE.....	88
3.25.3.	RESPONSIBILITY.....	88
3.25.4.	PRINCIPLE .....	88
3.25.5.	SAMPLE REQUIREMENTS.....	88
3.25.6.	EQUIPMENT .....	88
3.25.7.	MATERIALS .....	88
3.25.8.	STORAGE AND STABILITY .....	88
3.25.9.	SAFETY.....	88
3.25.10.	CALIBRATION .....	89
3.25.11.	QUALITY CONTROL.....	89
3.25.12.	PROCEDURE STEPS .....	89
3.25.13.	BIOLOGICAL REFERENCE .....	94
3.25.14.	INTERPRETATION AND REPORTING OF RESULTS .....	94
3.25.15.	LIMITATION OF THE PROCEDURE AND SOURCES OF ERROR .....	94
3.25.16.	PERFORMANCE CHARACTERISTICS .....	94
3.25.17.	BIOLOGICAL REFERENCE INTERVAL .....	94
3.25.18.	REFERENCES .....	94
3.26.	<b>PROCEDURE FOR DETERMINATION OF WEAK A AND B BLOOD GROUP ANTIGENS, AND COLD ANTIBODIES.....</b>	<b>95</b>
3.26.1.	PURPOSE .....	95
3.26.2.	SCOPE.....	95
3.26.3.	RESPONSIBILITY.....	95
3.26.4.	PRINCIPLE .....	95
3.26.5.	SAMPLE REQUIREMENTS.....	95
3.26.6.	EQUIPMENT .....	95
3.26.7.	MATERIALS .....	95
3.26.8.	STORAGE AND STABILITY.....	95
3.26.9.	SAFETY.....	96
3.26.10.	CALIBRATION .....	96
3.26.11.	QUALITY CONTROL.....	96
3.26.12.	PROCEDURE.....	96
3.26.13.	BIOLOGICAL REFERENCE INTERVAL .....	96
3.26.14.	REPORTING OF AND INTERPRETATION OF RESULTS .....	96
3.26.15.	LIMITATION THE PROCEDURE AND SOURCES OF ERRORS .....	96
3.26.16.	PERFORMANCE CHARACTERISTICS .....	97
3.26.17.	SUPPORTING DOCUMENTS .....	97
3.26.18.	REFERENCES .....	97
3.27.	<b>PROCEDURE FOR PERFORMING ABO-RH GROUPING AND ANTIBODIES SCREENING BY USING NEO IRIS ANALYZER.....</b>	<b>98</b>
3.27.1.	PURPOSE .....	98
3.27.2.	SCOPE.....	98
3.27.3.	RESPONSIBILITY.....	98
3.27.4.	PRINCIPLE .....	98
3.27.5.	SAMPLE REQUIREMENTS.....	98



3.27.6.	EQUIPMENT .....	98
3.27.7.	MATERIALS .....	99
3.27.8.	STORAGE AND STABILITY .....	99
3.27.9.	SAFETY.....	99
3.27.10.	CALIBRATION .....	99
3.27.11.	QUALITY CONTROLS SHOULD BE WITHIN ACCEPTABLE LIMITS .....	99
3.27.12.	PROCEDURE STEPS FOR RUNNING PATIENT SAMPLES .....	100
3.27.13.	BIOLOGICAL REFERENCE INTERVALS .....	103
3.27.14.	REPORTING AND INTERPRETING RESULTS .....	103
3.27.15.	LIMITATIONS OF THE PROCEDURE AND SOURCES OF ERRORS.....	104
3.27.16.	PERFORMANCE CHARACTERISTICS .....	104
3.27.17.	SUPPORTING DOCUMENTS .....	104
3.27.18.	REFERENCES .....	104
3.28.	PROCEDURE FOR ALBUMIN OR LISS-ADDITIVE INDIRECT ANTIGLOBULIN TEST.....	106
3.28.1.	PURPOSE .....	106
3.28.2.	SCOPE.....	106
3.28.3.	RESPONSIBILITY.....	106
3.28.4.	PRINCIPLE .....	106
3.28.5.	SAMPLE REQUIREMENTS.....	106
3.28.6.	EQUIPMENT .....	106
3.28.7.	MATERIALS .....	106
3.28.8.	STORAGE AND STABILITY .....	107
3.28.9.	SAFETY.....	107
3.28.10.	CALIBRATION .....	107
3.28.11.	QUALITY CONTROL.....	107
3.28.12.	PROCEDURE STEPS .....	107
3.28.13.	BIOLOGICAL REFERENCE INTERVALS .....	108
3.28.14.	REPORTING AND INTERPRETATION OF RESULTS .....	108
3.28.15.	LIMITATIONS OF THE PROCEDURE AND SOURCES OF ERROR.....	108
3.28.16.	PERFORMANCE CHARACTERISTICS .....	108
3.28.17.	SUPPORTING DOCUMENTS .....	108
3.28.18.	REFERENCES .....	108
3.29.	PROCEDURE FOR PERFORMING BLOOD TRANSFUSION TRANSMISSIBLE INFECTIONS (TTIS) BY USING ALINITY ANALYZER.....	109
3.29.1.	PURPOSE .....	109
3.29.2.	SCOPE.....	109
3.29.3.	RESPONSIBILITY.....	109
3.29.4.	PRINCIPLE .....	109
3.29.5.	SAMPLE REQUIREMENTS.....	109
3.29.6.	EQUIPMENT .....	109
3.29.7.	MATERIALS .....	109
3.29.8.	STORAGE AND STABILITY .....	109
3.29.9.	SAFETY.....	109
3.29.10.	CALIBRATION .....	110
3.29.11.	QUALITY CONTROL.....	111
3.29.12.	PROCEDURE STEPS .....	111
3.29.13.	BIOLOGICAL REFERENCE INTERVALS .....	112
3.29.14.	INTERPRETATION AND REPORTING OF RESULTS .....	112
3.29.15.	LIMITATIONS OF THE PROCEDURE AND SOURCES OF ERROR.....	113
3.29.16.	PERFORMANCE CHARACTERISTICS .....	113

3.29.17.	SUPPORTING DOCUMENTS .....	113
3.29.18.	REFERENCES .....	113
3.30.	PROCEDURE FOR PERFORMING BLOOD TRANSFUSION TRANSMISSIBLE INFECTIONS (TTI) BY USING ARCHITECT ANALYSER.....	114
3.30.1.	PURPOSE .....	114
3.30.2.	SCOPE.....	114
3.30.3.	RESPONSIBILITY .....	114
3.30.4.	PRINCIPLE .....	114
3.30.5.	SAMPLE REQUIREMENTS.....	114
3.30.6.	EQUIPMENT .....	114
3.30.7.	MATERIALS .....	114
3.30.8.	STORAGE AND STABILITY .....	114
3.30.9.	SAFETY.....	114
3.30.10.	CALIBRATION .....	115
3.30.11.	QUALITY CONTROL.....	115
3.30.12.	PROCEDURE STEPS .....	117
3.30.13.	REVIEW DONOR RESULTS.....	117
3.30.14.	BIOLOGICAL REFERENCE INTERVALS .....	117
3.30.15.	INTERPRETATION AND REPORTING OF RESULTS .....	117
3.30.16.	LIMITATIONS OF THE PROCEDURE AND SOURCES OF ERROR.....	117
3.30.17.	PERFORMANCE CHARACTERISTICS .....	117
3.30.18.	SUPPORTING DOCUMENTS .....	117
3.30.19.	REFERENCES .....	117

**CHAPTER 4: HAEMATOLOGY ..... 118**

4.1	PROCEDURE FOR SICKLING SCREENING TEST.....	118
4.2	PROCEDURE FOR URIT-12 HEMOGLOBIN METER.....	120
4.3	PROCEDURE FOR DETERMINATION OF HAEMOGLOBIN LEVEL USING HEMOCHROMAX PLUS 121	
4.4	PROCEDURE FOR DETERMINATION OF HEMOGLOBIN LEVEL USING HEMOCUE 201+ MACHINE 123	
4.5	PROCEDURE FOR CD 4 COUNT TEST BY USING BD FACS PRESTO .....	125
4.6	PROCEDURE FOR DETERMINATION OF CLOTTING TIME.....	129
4.7	PROCEDURE FOR DETERMINATION OF THE BLEEDING TIME .....	131
4.8	PROCEDURE FOR FULL BLOOD COUNT BY USING URIT BH – 40P HAEMATOLOGY ANALYSER. 133	
4.9	PROCEDURE FOR FULL BLOOD COUNT USING OF ABX PENTRA 80 HAEMATOLOGY ANALYSER. 136	
4.10	PROCEDURE FOR FULL BLOOD COUNT USING SINNOWA HB - 7021 .....	139
4.11	PROCEDURE FOR FULL BLOOD COUNT USING BHA 3000 HAEMATOLOGY ANALYSER .....	142
4.12	PROCEDURE FOR PERFORMING PERIPHERAL BLOOD SMEAR .....	145
4.13	PROCEDURE FOR PERFORMING FULL BLOOD COUNT BY USING MS4 HAEMATOLOGY ANALYSER.....	147
4.14	PROCEDURE FOR FULL BLOOD COUNT BY USING DYMIND DH-36 ANALYSER .....	150
4.15	PROCEDURE FOR FULL BLOOD COUNT USING DYMIND DH 76 HAEMATOLOGY ANALYSER.	153
4.16	PROCEDURE FOR FULL BLOOD COUNT USING SYSMEX XS-500i.....	156
4.17	PROCEDURE FOR FULL BLOOD COUNT BY USING SYSMEX XN - 550 ANALYSER .....	160
4.18	PROCEDURE FOR FULL BLOOD COUNT USING SYSMEX XN-1000/2000.....	165
4.19	PROCEDURE FOR FULL BLOOD PICTURE AND RETICULOCYTES USING URIT 5380 ANALYZER...	169

4.20	PROCEDURE FOR FULL BLOOD COUNT USING URIT- 5500 ANALYSER .....	172
4.21	PROCEDURE FOR MANUAL RETICULOCYTE COUNT.....	176
4.22	PROCEDURE FOR FULL BLOOD COUNT AND RETICULOCYTE COUNT USING CELL DYN RUBY SYSTEM .....	179
4.23	PROCEDURE FOR COAGULATION TEST USING SYSMEX CA 104 COAGULATION ANALYSER.	183
4.24	PROCEDURE FOR COAGULATION TEST USING SYSMEX CA 500 SERIES COAGULATION ANALYSER.....	186
4.25	PROCEDURE FOR COAGULATION TEST USING SYSMEX CA 600 COAGULATION ANALYSER.	190
4.26	PROCEDURE FOR COAGULATION TEST USING SYSMEX CA-660 COAGULATION ANALYZER.	193
4.27	PROCEDURE FOR COAGULATION TEST USING ACL TOP 500 COAGULATION ANALYSER.....	196
4.28	PROCEDURE FOR HAEMOGLOBIN ELECTROPHORESIS BY USING GAZELLE™ READER .....	199
4.29	PROCEDURE FOR HEMOGLOBIN ELECTROPHORESIS TEST BY USING SAS 1 AND SAS 2 ELECTROPHORESIS MACHINE.....	203
4.30	PROCEDURE FOR METHEMOGLOBIN REDUCTION TEST FOR GLUCOSE-6 PHOSPHATE DEHYDROGENASE (G-6PD).....	208
4.31	PROCEDURE FOR HAM TEST FOR PAROXYSMAL NOCTURNAL HEMOGLOBINURIA .....	211

**CHAPTER 5: CLINICAL CHEMISTRY AND IMMUNOLOGY .....** 213

5.1	PROCEDURE FOR BLOOD GLUCOSE BY USING ACCUCHECK GLUOCOMETER.....	213
5.2	PROCEDURE FOR TESTING BLOOD GLUCOSE BY GLUCO PLUS.....	217
5.3	PROCEDURE FOR URIT 50 (URINE CHEMISTRY ANALYZER) .....	220
5.4	PROCEDURE FOR (URIT-560) URINE ANALYZER .....	222
5.5	PROCEDURE FOR PERFORMING URINE BIOCHEMISTRY BY USING CYBOW READER 300 .....	224
5.6	PROCEDURE FOR DETERMINATION OF ALT BY USING DIRUI-DR 7000 CHEMISTRY ANALYZER 228	
5.7	PROCEDURE FOR DETERMINATION OF AST BY USING DIRUI-DR7000 CHEMISTRY ANALYZER 230	
5.8	PROCEDURE FOR SA-30 SEMI AUTOMATED CHEMISTRY ANALYZER .....	232
5.9	PROCEDURE FOR OPERATING CLINDIAG FA 200 CHEMISTRY TEST .....	235
5.10	PROCEDURE FOR DETERMINATION OF IMMUNOASSAYS BY USING GETEIN 1100 IMMUNOANALYSER .....	238
5.11	PROCEDURE FOR OPERATING FIA 8000 ANALYSER .....	240
5.12	PROCEDURE FOR OPERATING ALERE AFFINION AS100ANALYSER.....	243
5.13	PROCEDURE FOR OPERATING ST-200 ABG ANALYZERPURPOSE.....	246
5.14	PROCEDURE FOR OPERATING HUMASTAR 600.....	249
5.15	PROCEDURE FOR BASIC BIOCHEMISTRY TESTS BY USING XL-180 ANALYSER.....	252
5.16	PROCEDURE FOR OPERATING ERBA XL200/600/640 CHEMISTRY ANALYZER.....	256
5.17	PROCEDURE FOR CHEMISTRY TEST USING COBAS INTEGRA 400 PLUS CHEMISTRY ANALYSER 260	
5.18	PROCEDURE FOR PERFORMING CHEMISTRY TEST USING COBAS 6000.....	264
5.19	PROCEDURE FOR DETERMINATION OF BASIC BIOCHEMISTRY TEST USING ARCHITECTPLUS C4000 269	
5.20	PROCEDURE FOR OPERATING MAGLUMI 2000 ANALYZER .....	273
5.21	PROCEDURE FOR PERFORMING BASIC CHEMISTRY AND IMMUNOASSAY TESTS USING ARCHITECT Ci4100 PLUS ANALYSER.....	276
5.22	PROCEDURE FOR PERFORMING IMMUNOASSAY TESTS BY USING MAGLUMI 800 IMMUNO - ANALYSER.....	280
5.23	PROCEDURE FOR IMMUNOASSAYS BY USING ARCHITECT i1000SR .....	283

**CHAPTER 6: SEROLOGY ..... 285**

6.1	PROCEDURE FOR SYPHILIS ANTIBODIES RAPID TEST .....	285
6.2	PROCEDURE FOR (HIV) TESTING BY USING BIOLINETM HIV 1/2 3.0 TEST .....	289
6.3	PROCEDURE FOR PERFORMING (HIV) BY USING UNIGOLD TEST .....	292
6.4	PROCEDURE FOR URINE PREGNANCY TEST .....	295
6.5	PROCEDURE FOR HEPATITIS C ANTIBODY RAPID TEST .....	298
6.6	PROCEDURE FOR CRYPTOCOCCAL ANTIGEN RAPID TEST PROCEDURE .....	301
6.7	PROCEDURE FOR ANTISTREPTOLYSIN - O (ASOT) LATEX SLIDE TEST .....	304
6.8	PROCEDURE FOR PERFORMING (HBsAg) RAPID TEST.....	306
6.9	PROCEDURE FOR SARS-COV-2 ANTIGEN RAPID DIAGNOSTIC TEST .....	309
6.10	PROCEDURE FOR DENGUE VIRUS ANTIBODY DETECTION RAPID TEST.....	312
6.11	PROCEDURE FOR PLAGUE RAPID TEST .....	315
6.12	PROCEDURE FOR HELICOBACTER PYLORI ANTIGEN TEST .....	317
6.13	PROCEDURE FOR HELICOBACTER PYLORI ANTIBODY RAPID TEST .....	320
6.14	PROCEDURE FOR BRUCELLA ANTIBODY DETECTION .....	323
6.15	PROCEDURE FOR SALMONELLA TYPHI ANTIBODIES QUANTIFICATION METHOD.....	325
6.16	PROCEDURE FOR RHEUMATOID FACTOR TEST .....	329
6.17	PROCEDURE FOR CONFIRMATION OF TREPONEMA PALIDUM BY TREPONEMA PALLIDUM HAEMAGLUTINATION ANTIGEN (TPHA) .....	331
6.18	PROCEDURE FOR CHORELA RAPID DIAGNOSTIC TEST .....	335

**CHAPTER 7: BACTERIOLOGY AND MYCOLOGY..... 339**

7.1	POTASSIUM HYDROXIDE (KOH) WET MOUNT PREPARATION .....	339
7.2	PROCEDURE FOR ZIEHL NIELSEN (ZN) STAIN.....	342
7.3	PROCEDURE FOR AURAMINE O PHENOL STAINING .....	345
7.4	PROCEDURE FOR GRAMS STAINING .....	349
7.5	PROCEDURE FOR INDIAN INK STAIN .....	352
7.6	PREPARATION OF CULTURE MEDIA .....	356
7.7	URINE CULTURE.....	367
7.8	STOOL CULTURE .....	371
7.9	UROGENITAL SAMPLES/URETHRAL SWAB CULTURE .....	377
7.10	MANUAL BLOOD CULTURE.....	382
7.11	AUTOMATED BLOOD CULTURE BD BACTEC FX40.....	386
7.12	CEREBROSPINAL FLUID (CSF) ANALYSIS.....	395
7.13	CULTURE OF BODY FLUID OTHER THAN CSF (PLEURAL FLUID, PERITONEAL FLUID, AND SYNOVIAL FLUID) .....	402
7.14	EXAMINATION OF WOUND (PUS AND ABSCESS) .....	406
7.15	SPUTUM CULTURE FOR PATHOGENS OTHER THAN MTB CAUSING AGENTS .....	409
7.16	PROCESSING AND CULTURING OF SAMPLES FOR FUNGAL INFECTION .....	412
7.17	CATALASE TEST.....	420
7.18	COAGULASE TEST .....	424
7.19	NOVOBIOCIN TEST.....	428
7.20	BACITRACIN TEST .....	431
7.21	PYRRIDONYL AMINOPEPTIDASE (PYR) TEST.....	435
7.22	OPTOCHIN TEST.....	438
7.23	BILE SOLUBILITY TEST.....	441
7.24	INDOLE TEST.....	446

7.25	OXIDASE TEST.....	448
7.26	UREASE TEST .....	451
7.27	TRIPLE SUGAR IRON/KIA .....	455
7.28	GERM TUBE TEST .....	461
7.29	ANALYTICAL PROFILE INDEX (API 20E) .....	466
7.30	ANTIBIOTIC SUSCEPTIBILITY TESTING BY KIRBY BAUER DISK DIFFUSION METHOD .....	471
7.31	MANAGEMENT OF BACTERIAL ISOLATES .....	481
7.32	DETECTION OF COMMON BACTERIAL RESISTANCE MECHANISM .....	486

**CHAPTER 8: MOLECULAR BIOLOGY..... 494**

8.1	DIAGNOSIS OF MTB/RIF TESTING USING A TRUENAT MACHINE.....	494
8.2	DIAGNOSIS OF MTB/RIF BY USING GENE XPERT SYSTEM .....	500
8.3	DETERMINATION OF HIV -1 VIRAL LOAD BY USING GENE EXPERT SYSTEM.....	504
8.4	DETERMINATION OF HIV EARLY INFANT DIAGNOSIS BY USING GENEXPERT SYSTEM.....	516
8.5	DETERMINATION OF HIV-1 VIRAL LOAD BY USING COBAS AMPLIPREP/COBASTAQMAN (CAP/CTM) 96 .....	526
8.6	DETERMINATION OF HIV EARLY INFANT DIAGNOSIS BY USING COBAS AMPLIPREP/TAQMAN 531	
8.7	DETERMINATION OF HIV-1 VIRAL LOAD BY USING COBAS (CAP/CTM) 6800/8800.....	537
8.8	DETERMINATION OF HIV-1 VIRAL LOAD BY USING COBAS (CAP/CTM) 4800.....	546
8.9	DETERMINATION OF HIV-1 VIRAL LOAD BY USING M2000SP/RT .....	550
8.10	INVESTIGATION OF CHRONIC MYELOID LEUKEMIA BY USING GENE XPERT MACHINE.....	555

**CHAPTER 9: ANATOMICAL PATHOLOGY..... 558**

9.1	PROCEDURE FOR PERFORMING SEMINALYSIS.....	558
9.2	PROCEDURE FOR MORTUARY SERVICES .....	567
9.3	PROCEDURE FOR TISSUE GROSSING .....	574
9.4	PROCEDURE FOR TISSUE SECTION CUTTING USING ROTARY MICROTOME .....	577
9.5	PROCEDURE FOR PERFORMING TISSUE EMBEDDING.....	580
9.6	PROCEDURE FOR TISSUE PROCESSING BY USING AUTOMATED PROCESSOR MACHINE .....	583
9.7	PROCEDURE FOR PERFORMING PAPANICOLAU’S STAIN .....	586
9.8	PROCEDURE FOR PERFORMING HEMATOXYLIN AND EOSIN STAIN.....	589
9.9	PROCEDURE FOR PERFORMING PHOSPHOTUNGSTIC ACID STAIN .....	592
9.10	PROCEDURE FOR PERFORMING PERIODIC ACID SCHIFF .....	596
9.11	PROCEDURE FOR PERFORMING PERL’S PRUSSIAN BLUE STAINING.....	599
9.12	PROCEDURE FOR ACID - FAST MYCOBACTERIUM IN TISSUE SECTION.....	602
9.13	VERHOFF’S ELASTIC STAIN.....	605
9.14	VAN GIESON’S PICRIC ACID-ACID FUCHSIN STAIN .....	608
9.15	PROCEDURE FOR PERFORMING IMMUNOHISTOCHEMISTRY. ....	611

**NOTE PAD..... 627**

**NOTE PAD..... 628**

**NOTE PAD..... 629**

Annex 1: List of Subject Matter Experts who developed these SOPs.....	615
Annex 2: Biological Reference Intervals for Full Blood Count.....	617
Annex 3: Biological Reference Intervals for Coagulation Profile.....	618
Annex 4: Biological Reference Intervals for Urine Biochemistry .....	619
Annex 5: Biological Reference Intervals for Clinical Chemistry and Immunoassays 620	
Annex 6: Critical/Panic Values Requiring Immediate Actions .....	624
Annex 7: Charts of Biochemical Identifications of common Enterobacteriaceae and Enteric Organisms.....	625

## ABBREVIATIONS AND ACRONYMS

---

For the purposes of this NMLSOP document, these abbreviations and acronyms will apply:

Abbreviations	Acronyms
AIDS	Acquired Immunodeficiency Syndrome
AJLM	African Journal for Laboratory Medicine
AMMP-1	Adult Morbidity and Mortality Project Phase 1
AMR	Antimicrobial Resistance
ANC	Antenatal Care
BMC	Bugando Medical Centre
BRM	Bio risk Management
BSC	Biological Safety Cabinet
BSc	Bachelor of Science
BSL	Biosafety Level
BUQ	Bottom-Up Quantification
CCM	Chama Cha Mapinduzi ( <i>Ruling Party in the United Republic of Tanzania</i> )
CD4	Cluster of Differentiation 4
CDC	Centres for Disease Control and Prevention
CDs	Cluster of Differentiations
CEPD	Continuing Education and Professional Development
CHF	Community Health Financing
CHMT	Council Health Management Team
CHSB	Council Health Service Board
CHWs	Community Health Workers
CLS	Community Laboratory Services
CLSI	Clinical and Laboratory Standards Institute
CPD	Continuing Professional Development
CPL	Central Pathology Laboratory
CTRL	Central Tuberculosis Reference Laboratories
DDHCTSU	Director, Diagnostic and Health Care Technical Services Unit
DED	District Executive Director
DHs	District Hospitals
DLTs	District Laboratory Technologists
DMO	District Medical Officer
DO	Data Officer
DP	Development Partner
DQA	Data Quality Assurance
DTS	Dried Tube Sample

Abbreviations	Acronyms
eLIS	electronic Laboratory Information System
eLMIS	Electronic Logistics Management Information System
EOC	Emergency Operations Centre
EQA	External Quality Assessment
FBO	Faith Based Organisations
FYDP	Five Years' Development Plan
GCLA	Government Chemistry Laboratory Agency
GHSA	Global Health Security Agenda
GOT	Government of Tanzania
HCRF	Health Commodity Revolving Fund
HCTS	Health Care Technical Services
HIV	Human Immunodeficiency Virus
HLI	Health Links Initiative
HLPC	Health Laboratory Practitioners' Council
HMIS	Health Management Information Systems
HMTs	Health Management Teams
HSSP IV	Health Sector Strategic Plan IV
HSSP V	Health Sector Strategic Plan V
IATA	International Air Transport Association
ICAP	International Centre for AIDS Care and Treatment Programs
IDSR	Integrated Disease Surveillance and Response
IHR	International Health Regulations
ISBN	International Standard Book Number
ISO	International Organization for Standardization
IT	Information Technology
KCMC	Kilimanjaro Christian Medical Centre
KIU	Kampala International University
KPI	Key Performance Indicator
LEMM	Laboratory Equipment Management Module
LIO	Laboratory Information Officer
LIS	Laboratory Information System
LMIS	Logistic Management Information System
LO	Logistic Officer
LQA	Laboratory Quality Assurance
MDG	Millennium Development Goals
MeLSAT	Medical Laboratory Scientists Association of Tanzania
MMAM	Mpango wa Maendeleo ya Afya ya Msingi
MNCH	Mother and Neonatal Child Health
MoH	Ministry of Health
MOU	Memorandum of Understanding



Abbreviations	Acronyms
MS	Marketing Surveillance
MSc	Master of Science
MSD	Medical Stores Department
MSD	Medical Stores Department
MTBDR	Mycobacterium Tuberculosis Drug Resistance
MTEF	Medium Term Expenditure Framework
MUHAS	Muhimbili University of Health and Allied Sciences
NACP	National AIDS Control Programme
NACTE	National Council for Technical Education
NBTS	National Blood Transfusion Services
NCDs	Non-Communicable Diseases
NGO	Non-Governmental Organization
NHLS	National Health Laboratory Services
NHLSP	National Health Laboratory Strategic Plan
NIMR	National Institute for Medical Research
NMCP	National Malaria Control Programme
NMLSSP III	National Medical Laboratory Services Strategic Plan III
NPHL	National Public Health Laboratory
NPHLA	National Public Health Laboratory Agency
NRL	National Reference Laboratory
NSCLQS	National Sub-Committee on Laboratory Quality System
NSGHLs	National Standard Guidelines for Health Laboratory Services
NSGRP	National Strategy for Growth and Reduction of Poverty
NSLQMS	National Sub-committee for Laboratory Quality Management Systems
NSOPML	National Standard Operating Procedures for Medical Laboratories
NTDs	Neglected Tropical Diseases
NTP	National Tuberculosis and Leprosy Programme
PEPFAR	President's Emergency Plan for AIDS Relief
PHDR	Poverty and Human Development Report
PHIA	Population-based HIV Impact Assessment
PHLB	Private Health Laboratory Board
PHLS	Public Health Laboratory Services
PLHIV	People Living with HIV and AIDS
PO-RALG	President's Office-Regional Administration and Local Government
POC	Point of Care
PPM	Planned Preventive Maintenance
PPP	Public Private Partnership

Abbreviations	Acronyms
PT	Proficiency Testing
QA	Quality Assurance
QC	Quality Control
QMS	Quality Management System
QO	Quality Officer
RAS	Regional Administrative Secretary
RBF	Results-based Financing
RFM	Result Framework Matrix
RHMT	Regional Health Management Team
RLQA	Regional Laboratory Quality Assurance
RLTs	Regional Laboratory Technologists
RMO	Regional Medical Officer
RRH	Region Referral Hospital
RTQII	Rapid Testing Quality Improvement Initiative
SADC	Southern African Development Community
SADCAS	Southern African Development Community Accreditation System
SCM	Supply Chain Management
SD	Standard Deviation
SDG	Sustainable Development Goals
SLIPTA	Stepwise Laboratory Improvement Process Towards Accreditation
SLMTA	Strengthening Laboratory Management Toward Accreditation
SO	Safety Officer
SWOC	Strength Weakness Opportunities and Challenges
TA	Technical Assistance
TB	Tuberculosis
TCU	Tanzania Commission for Universities
THPS	Tanzania Health Promotion Support
TIKA	Tiba kwa Kadi
TMDA	Tanzania Medicine and Medical Devices Authority
TOR	Terms of Reference
TOT	Trainer Of Trainee
TSPAS	Tanzania Service Provision Assessment Survey
URT	United Republic of Tanzania
WHO	World Health Organization
ZACDS	Zonal Advisory Committee on Diagnostic Services

# TERMS AND DEFINITIONS

---

For the purposes of this NMLSOP document, these terms and definitions will apply:

Terms	Applicable Definitions
Demand	Refers to consumers' desire to acquire the services, and the willingness to pay for it.
Access	Refers to the ability of people to reach places and services and the ability of places to be reached by people and goods
Quality	Refers to the degree to which a set of inherent characteristics of products or service fulfils requirements
Resilience	Refers to the process of adapting well in the face of adversity, trauma, tragedy, threats, or significant sources of stress - such as relationship problems, serious health problems, or workplace and financial stressors
Accountability	Refers to responsibility of an individual to complete assigned tasks and to perform the duties required by their job
Learning	Refers to the process of acquiring new understanding, knowledge, behaviours, skills, values, attitudes and preferences
Operational plan	Refers to a comprehensive and actionable plan that defines how team's functions and activities contribute to an organizations overall business goal

# FOREWORD

---

This is the first National Medical Laboratory Standard Operating Procedure NMLSOP.

The document outlines the Standard Operating Procedures that the laboratory tests are to be performed in various facilities during the period of one year's towards strengthening the provision of quality medical laboratory services. The plan was developed through consultative process involving various stakeholders within the Ministry of Health and other Ministry of the government of Tanzania.

This plan describes the background of medical laboratory sciences, as well as the context in which it was established in the country. It also features the current roles, functions and structure of the organization. Furthermore, contents of the plan include; stakeholders' analysis, strengths, weaknesses, opportunities, and challenges that face medical laboratory services. In identifying these elements, SWOC and Political, Economic, Social, Technological, Environmental and Legal (PESTEL) analysis were used.

The NMLSOP have been developed in line with the other medical laboratory's technical procedures. This NMLSOP is presented in nine (9) chapters set in a path to overcome the weaknesses and challenges as well as proving a tool to take advantage of organization's strength in exploring the existing opportunities. The SOPs include purpose, scope, responsibilities, principle and many steps. This NMLSOP is expected to be reviewed annually from January 2024 to January 2025.

Successful implementation of this NMLSOP depends on the availability of technical and financial resources to coordinate its execution. Hence, all stakeholders should be aware of their roles and responsibilities at the national, regional, and council levels outlined in this strategy. It is expected that, MoH through the Director, Diagnostic and Health Care Technical Services Unit (DDS) will provide the required leadership and guidance.



**Dr. John A. K. Jingu**  
**PERMANENT SECRETARY**

## **ACKNOWLEDGEMENTS**

---

The National Medical Laboratory Standard Operating Procedure (NMLSOP) is a product of dedicated efforts and contributions of various stakeholders. The MoH acknowledges the contribution of PO-RALG, Development and Implementing Partners, Non-Government Organisations (NGOs), Institutions or facilities (National Hospitals, Zonal Hospitals, Specialised Hospitals, Regional Referral Hospitals, District Hospitals, Health Centers, Dispensaries), Regulatory Agencies (Health Laboratory Practitioner’s Council and Private Health Laboratories Board), Programmes (NASHCoP, NTLP, NMCP, NBTS) and Individuals towards improving the quality of health care service delivery through improved medical laboratory services.

In particular, the MoH would like to thank the Global Fund (GF) and Centres for Disease Control and Prevention (CDC) for their financial and technical support through the consultancy in development of this strategic plan. Special appreciations are extended to technical experts and individuals for their active participation and constructive inputs and comments provided in reviewing this guideline (**ANNEX 01**).

Our appreciations go to the Director of diagnostic and Health Care Technical Services Unit (DDS) Dr Alex S. Magesa for steering up the whole process; Acting Head of Laboratory Services (Ag. HLS) Mr Reuben S. Mkala for field coordination; and to all laboratory technical team or individuals who played a pivotal role in developing this NMLSOP by participating in the consultation workshops, meetings, providing relevant information and offering their expert opinion when consulted. Last but not the least; appreciations go to David Ocheng, who facilitated the whole process of developing this document.



**Prof. Tumaini J. Nagu**  
**CHIEF MEDICAL OFFICER**

# EXECUTIVE SUMMARY

---

In developing this National Medical Laboratory Standard Operating Procedure (NMLSOP) for the period 2024-2025 consideration has been made on a number of National and International guiding and operational guidelines. National Standard for Medical Laboratories (2017); Health Care Technology Policy Guideline (2004); Operational Plan for the National Laboratory System to Support HIV and AIDS Care and Treatment (2005); National Laboratory Quality Assurance Framework to Support Health Care Interventions (2007); Standard Guidelines for the Facilities and Operations of Forensic Bureau Laboratory (2008); International Health Regulations (IHR) of 2005; Global Health Security Agenda (GHSA) 2024 Framework; and the Ruling Party Election Manifesto 2020.

The main objective of this SOPs is to enable the laboratories at all levels to effectively and efficiently carry out their core functions of laboratory tests as stipulated by their mandate, strategically coordinate and allocate the available resources by prioritising functions with effective impact in line with the National Health Policy (2007) and the Sustainable Development Goals (SDGs).

There are four chapters in this document. Chapter one provides; a brief introduction and background information, justification and objectives for the NMLSOP.

This National Medical Laboratory Standard Operating Procedure has four strategic directions:

1. Enhanced conducive Political, Social and Economic environment for Medical Laboratory services (Resilience);
2. Improved and strengthened Medical Laboratory Diagnostic services (Access);
3. Heightened effective collaboration and partnerships for coordinated action (Demand);
4. Strengthened Quality Management systems, Surveillance and Monitoring and Evaluation (Quality).

For each objective above, strategies, targets, activities and performance indicators were derived. The NMLSOP Matrix specifically describes the sequence of objectives, strategies, targets, activities and performance indicators are considered the guiding framework for the development and implementation of annual operational plans.

## SCOPE

---

The scope of this National Medical Laboratory Standard Operating Procedure (NMLSOP) is to provide a step by step instructions for performing laboratory tests.

## **PRIMARY BENEFICIARIES**

---

The primary beneficiaries are Laboratory Practitioners' who perform examination of biological samples in the laboratories and non-laboratory testers performed specialised laboratory tests at point-of-care testing sites.

## **SECONDARY BENEFICIARIES**

---

The users of this document will include but not be limited to:

Policy makers, medical care managers and administrators, medical devices regulatory authorities, medical laboratories, intervention programmes, Regional Health Management Teams and Council Health Management Teams, zonal medical equipment workshops, biomedical engineers, healthcare technical services and end-users engaged in strengthening the quality of medical diagnostic services in the country.

Additionally, other beneficiaries include: Development and Implementing Partners who provide technical assistance to support the Government of Tanzania (GOT) to implement the medical laboratory agenda, public and private medical institutions and laboratories, and higher learning medical laboratory training institutions, prospective accrediting agencies, medical professional bodies and clinical laboratory medicine.

The objective of NMLSOP is to ensure that Laboratory personnel implement National Medical Laboratory Standard Operating Procedure for continuity of quality medical diagnostic laboratory services as needed by the clients.

# CHAPTER 1: SAMPLE COLLECTION

---

## GENERAL CONSIDERATIONS

The collection of samples for laboratory tests from patients consists of following steps:

- i. Documentation/Registration of the patient
- ii. Collection of sample
- iii. Dispatch of sample to respective department

### **1.1.1 Handling of Biological Samples**

Laboratory staffs are often confronted with the problem of handling of biological samples from patients. The following must be observed for personal protection;

- i. All biological samples must be considered hazardous and infected.
- ii. Wearing of personal protective equipment (PPEs),
- iii. Exercising due care to prevent spillage/splashes while transferring blood to containers from syringe,
- iv. The sample containers be labelled with adequate information.

### **1.1.2 Samples for Culture**

- i. As far as possible samples for culture should be obtained before administration of antimicrobial agents.
- ii. If it is not possible, then the laboratory should be informed about the therapeutic agent(s) so that this fact is considered before issuing laboratory report.
- iii. Material should be collected from the appropriate site where the likelihood and possibility of isolation of suspected organisms is high.
- iv. Sometimes patient's active participation is necessary for sample collection (sputum or urine), so he/she should be instructed properly and accordingly.
- v. Sufficient quantity of samples is to be collected to permit complete examination.
- vi. Samples are to be placed in sterile containers.
- vii. Some samples are directly collected in culture media. Contact laboratory if such collection is required.
- viii. Proper labelling of samples should always be done with patient's name, test type, date and site of collection etc.
- ix. The relevant clinical information is to be recorded on the request form.
- x. Any condition, circumstances or situation that will require special procedures should also be noted on the request form.
- xi. Samples should be collected during working hours except in emergency, so that the services of qualified microbiologist will be available to directly supervise processing of the sample.
- xii. The most appropriate samples for isolation of viral, chlamydial or rickettsial agents depend on the nature of the illness.



- xiii. The material should be collected as early as possible in the acute phase of the disease, because these agents tend to disappear relatively rapidly after the onset of the symptoms.
- xiv. Vesicle fluid is preferably collected in a syringe or capillary pipette and immediately diluted in an equal volume of skimmed milk or tissue culture medium.
- xv. All samples for viral culture should be frozen and stored at -70°C until culture is initiated.

### **1.1.3 Dispatch of Samples from Reception to the Laboratory Sections**

- i. Match the containers and respective request forms, number them and enter in the dispatch register/computer.
- ii. Verify while handing over/taking away to respective department of the laboratory.
- iii. Notify the concerned department about urgent and special tests.

### **1.1.4 Sample Transportation**

- i. Exterior of the container should not be soiled/contaminated with the samples.
- ii. Sufficient absorbent materials must be used to pack the sample, so that it absorbs the spilled liquid in case of leakage/breakage during transit to reference/referral laboratory.
- iii. Sample containers must be leak proof and unbreakable. Plastic containers are preferred.
- iv. Samples must be promptly delivered to the laboratory for valid results.
- v. If applicable, appropriate transport media should be used.
- vi. Samples are to be refrigerated or incubated at 37°C, as the case may be, if there is a delay in transport of samples to laboratory.
- vii. An appropriately filled request form should always accompany all samples to guide the pathologist/ health laboratory practitioner in selection of suitable media or appropriate technique.

## **1.2 COLLECTION OF BLOOD SAMPLES**

Consider the following recommended order of veins during blood drawing;

- Median cubital vein (first choice),
- Cephalic vein (second choice),
- Basilic vein (third choice).

### **1.2.1 Blood sample for serology**

- i. Serological tests are required in most of the bacterial, viral and parasitic diseases.
- ii. A clotted blood sample is preferred.
- iii. A vacuum collection system is both convenient as well as reliable.

- iv. Wherever applicable, paired samples are to be collected during acute and convalescent phases of illness in certain viral and other infections to document a diagnostic rise in antibody titre.
- v. Protect blood samples from extremes of heat and cold during transport.
- vi. Whole blood is to be stored at 2-8°C.
- vii. Serum can be frozen at -20°C or lower temperature for long term storage.

### **1.2.2 Blood sample for culture**

- i. Make sure you have the appropriate media for blood culture, as the media may vary depending upon the type of pathogen suspected.
- ii. Wash the hands with soap and water and wear sterile gloves.
- iii. Withdraw the blood following the procedure described on the procedure for collection of venous blood. Change needle before injecting the blood into the culture bottle.
- iv. Thoroughly clean the rubber bung of the culture bottle with iodine solution and inject an amount of blood equal to 10% of the volume of medium (for 30 ml medium 3 ml blood and for 50 ml medium, 5 ml blood is needed).
- v. After the needle has been removed, the site should be cleaned with 70% alcohol/spirit swab again.
- vi. Don't store the containers and caps separately.
- vii. Blood obtained for culture of suspected anaerobes should not be exposed to air in any way.

### **1.2.3 Venous blood**

- i. Welcome and greet the patient, introduce yourself.
- ii. Make the patient sit comfortably on the phlebotomy chair.
- iii. Identify the patient by asking his/her particulars and compare them with the request form.
- iv. Check the request form for the requested investigations and Inform the patient about the samples to be collected.
- v. Where possible, ask the patient to remove any tight - fitting sleeved clothing, or to roll up loose sleeves.
- vi. Label the containers before obtaining sample.
- vii. Select syringe of appropriate size so that the quantity of blood required can be obtained in single prick. If multiple or high volume of samples is required, use a butterfly needle or a canula.
- viii. Select appropriate vein (preferably antecubital) from forearm. Cleanse the skin over the venepuncture site in a circle approximately 5 cm in diameter with 70% alcohol/spirit swab and allow to air dry, do not blow.
- ix. If the sample is to be collected for blood culture then skin is to be thoroughly sterilised, following the procedure as follows:

- a. Starting in the centre of a circle
- b. apply 2% iodine (or povidone-iodine)
- c. in everwidening circles until the entire
- d. chosen area has been saturated with iodine.
- e. Allow the iodine to dry on the skin for at least 1 min.



- f. Completely remove the iodine with 70% alcohol/spirit swab following the pattern of application.
- x. Apply a tourniquet tight enough to obstruct venous flow only and relocate the vein to be punctured but don't touch the proposed site of needle entry or the needle itself. Ask the patient to clench the fist to make the veins prominent. If the vein is not visible, palpate it with fingers. In case the veins of forearm are not visible/palpable, other sites such as dorsum of the hand may be selected.
- xi. With bevel up, insert the correct needle size on the veins at an angle between 15 - 30° then draw the blood into the appropriate collection tubes, (make sure the patient arm in a downward position to prevent reflux).
- xii. Mix immediately after drawing each tube that contain an additive by gently inverting the tube 8 - 10 times. Do not mix vigorously in order to avoid haemolysis.
- xiii. Release the tourniquet from the patient, Withdraw the needle and apply pressure to the puncture site using dry cotton balls/gauze pad. Do not withdraw the piston too forcefully as it can collapse the vein and it may cause frothing/ haemolysis of the sample.
- xiv. Apply pressure with thumb on antiseptic swab at puncture site for 2 - 4 min till the blood ooze stops.
- xv. If syringe was used, safely remove the needle from the syringe before distribution.
- xvi. The blood from syringe is distributed to appropriate, labelled containers.

**NOTE:**

In case of multiple blood sample collection, consider the following recommended order of draw;

- First tube blood culture,
- Second tube: non-additive tube (e.g. red stopper),
- Third tube: coagulation tube (e.g. blue stopper),
- Last tube: additive tube (e.g. lavender or green tube).

**1.2.4 Capillary Blood Collection**

- i. Wear sterile gloves
- ii. Assemble All Collection Tools
- iii. Clean the ring fingertip with 70% isopropyl alcohol swab or 70% spirit starting the middle and leave outward to prevent contaminating the area,
- iv. Leave the site to air-dry,

- v. Hold the finger firmly place the new sterile lancet device at the site on the finger,
- vi. Wipe first drop of blood with a clean dry gauze or cotton wool,
- vii. Collect the sample with the second drop of blood using appropriate sample collection devices such as blood capillary tube,
- viii. Apply pressure with a clean dry gauze pad or cotton wool until bleeding stop,
- ix. Transfer the collected blood sample into appropriate sample container or testing devices.

#### **1.2.5 Procedure for Performing Neonate Capillary Blood Collection**

- i. Use the most medial or lateral portions of the planter surface of the heel Limit the depth of the puncture wound by using an automated lancet.
- ii. Only consider using the whole plantar surface of the foot (using automated lancets of 2.2mm in length or less) for neonates over 33 weeks' gestation if they are having multiple/frequent heel pricks
- iii. Position the neonate: ensure the foot is lower than the body.
- iv. Choose a puncture site – do not use a previous puncture site.
  - v. Clean the heel site (i.e. gauze and water) if the foot appears unclean (e.g. faecal material).
- vi. Encircle the foot with the palm of the hand and the index finger.
- vii. Make a quick puncture with the automated lancet device
- viii. Wipe off the first drop of blood with a gauze swab
- ix. Collect the sample with the second drop of blood using any of the collection devices such as slides or rapid test
- x. Apply pressure with a clean dry gauze pad until bleeding stop

### **1.3 COLLECTION OF URINE SAMPLES**

Urine samples are collected for routine and culture examinations to diagnose urinary tract infections (UTIs), both lower UTIs (cystitis-infection of the bladder) and upper UTIs (pyelonephritis-infection of the kidney). Unlike most other cultures, colony counts are done on urine samples to determine the number of organisms present in the sample. Generally, >100,000 organisms/ml of a single isolate indicate an individual has a UTI. However, mixed UTIs do occur and some individuals with UTIs will have counts lower than 100,000 organisms/ml.

Most organisms that cause UTIs are normal enteric flora, including *E. coli*, *Proteus*, *Klebsiella*, *Enterobacter*, and *Enterococcus* species. In young, otherwise healthy, sexually active females, *Staphylococcus saprophyticus* can be found to be the cause of UTI.

UTIs caused by *Proteus* species can be complicated by the formation of urinary calculi or stones. The large amount of urease that *Proteus* produces can alkalize the urine. If there are minerals such as phosphates or carbonates in the urine, the alkaline pH can cause them to precipitate out and form stones.

#### **1.3.1 TYPES OF URINE SAMPLE**

##### **A. First morning urine sample**

It provides concentrated urine as the bladder incubated it the whole night. It is best for nitrite, protein, good for microscopic examination and culture and sensitivity. The casts may have deteriorated and bacteria may affect true glucose reading.

##### **B. Random (routine) urine sample**

It is the most common type and most convenient sample. It is good for observing physical characteristics, chemical analysis and identification of casts, crystals and cells.

##### **C. Second-voided urine sample**

The first morning sample is discarded and second sample is collected. Formed elements remain intact.

##### **D. Mid stream (clean catch) urine sample**

The portion of urine that does not contain the first and last portions of the sample.

##### **E. Post-prandial**

It is collected after meal (usually after 2 hours). It is good for glucose and protein estimation. Urine sugar testing now has limited diagnostic or prognostic value.

##### **F. Timed sample**

It is a combination of all voiding over a length of time. Two-hour sample is good for urobilinogen and 24-hour sample is good for quantitative urinary components estimation. Timed urine samples are collected in dynamic function tests.

### **G. Foley catheter**

Disinfect a portion of the catheter with alcohol, puncturing the tubing directly with a sterile syringe and needle and aspirate the urine. Place urine in a sterile container, it should never be collected from drainage bag.

### **H. Suprapubic urine**

Urine sample collected by suprapubic aspiration and cystoscopy.

#### **1.3.2 Procedures for Collection of Urine Sample**

Urine sample is often collected by patient him/herself. Therefore, the patient needs to be properly instructed to have correct sample collection. An uncontaminated mid-stream urine (MSU) sample is the best and following methods are to be used for its collection:

##### **A. Females**

- i. Wash the genital area thoroughly with - Clean water (may be omitted for urine Routine Examination).
- ii. With two fingers of one hand, hold the outer folds of vagina (labia) apart. With the other hand, rinse the area from the front to the back with running tap water.
- iii. Start urination so that the stream of urine should flow without touching the skin. After a few moments, place a sterile container under the stream of urine. Remove it from the urine stream the moment required amount of urine is collected.
- iv. Secure and tighten the cap on the container.

##### **B. Males**

- i. Wash the genital, area thoroughly with Clean water (may be omitted for urine Routine Examination).
- ii. Start urination and after a few moments, place a sterile container under the stream of urine. Collect the required amount of urine and remove the container from urine stream.
- iii. Secure and tighten the cap.

##### **C. Infants, uncooperative and debilitated patients**

- i. Plastic bags may be attached after careful and thorough washing of genital area.
- ii. The bags should be watched so that they can be removed immediately after patient has passed the urine.
- iii. If the patient has not voided urine within 30 min the collecting bag is removed.
- iv. Patient needs to be re-scrubbed and a new collection device is to be attached.

#### **D. Urine collection for *Mycobacterium tuberculosis***

- i. Three consecutive early morning samples (>90 ml each) collected in sterile container are superior to 24h collection.
- ii. Boric acid (1.6%) is used as preservative in case of 24h urine collection in exceptional situations e.g., when patient cannot report daily for sampling.
- iii. Suprapubic aspiration in ward by a doctor is preferred in catheterised patients.

#### **1.4 FAECAL SAMPLES COLLECTION PROCEDURE**

Faecal samples are collected for routine and culture examinations to find the causative agent of infectious diarrhoea. Rectal swabs are often helpful in identifying the cause of acute bacterial diarrhoea when stool sample cannot be collected readily.

It is important to remember that there are many causes of diarrhoea other than infectious agents such as metabolic disorders, certain drugs, and food intolerances (allergies). In a routine stool culture, the following organisms are often isolated: *Salmonella* species, *Shigella* species and *Vibrio cholera*. Viruses and parasites are also common causes of diarrheal disease.

##### **1.4.1 Procedure for Collection of faecal samples**

- i. Faeces should be passed directly into a clean, waxed cardboard container that is fitted with a tight cover.
- ii. Avoid contact with residual soap/detergent, disinfectant or urine in the bedpan.
- iii. Faeces obtained are transferred to another clean, wide mouthed and screw capped container. The sample should include any pus, blood, mucus or formed elements that may have passed with stool.
- iv. Sample (~1 ml) is added to 10 ml sterile alkaline peptone water in suspected cholera cases.
- v. If viral infection is suspected, faeces are extracted with sterile buffered saline. Faeces (~1 ml) are mixed with 9 ml sterile buffered saline, allowed to sediment for 30 min (or centrifuged). The supernatant is transferred to a sterile container, frozen and kept below -40°C until processed.

## 1.5 COLLECTION OF BODY FLUIDS

The primary body fluid that are collected for routine and culture examinations includes; cerebrospinal fluid (CSF), joint fluid, pleural fluid, and peritoneal (ascites) fluid.

### 1.5.1 Cerebrospinal fluid (CSF)

- CSF routine and culture examinations are performed to diagnose meningitis due to Viruses, fungi, and bacteria. Acute bacterial meningitis (ABM) is a medical emergency.
- The age and immune status of the patient influence the type of bacterial pathogen most likely to cause ABM:
- Neonates 0 – 2 months; *E. coli*, *Streptococcus agalactiae* - Group B streptococci, *Listeria monocytogenes*
- 2 months - 2 years; *Haemophilus influenza* and *Neisseria meningitidis*
- Older than 2 years; *Neisseria meningitidis* – most common in children and young adults, *Streptococcus pneumoniae* – most common in older adults

#### 1.5.1.1 Procedures for Collection of CSF samples

CSF is normally collected from sub-arachnoid space of spinal cord at lumbar level by puncture with a long needle. A physician in the ward under strict aseptic conditions performs the procedure.

- i. Sample shall be collected in 2-4 ml quantities in 3-4 sterile screw capped bottles that are serially numbered and must be sent to the laboratory immediately.
- ii. In case CSF is to be cultured for *M. tuberculosis* then at least 5 ml sample is needed. CSF shall be tested as soon as it arrives in the laboratory.
- iii. CSF in the first bottle is sometimes contaminated with blood and should be kept aside.
- iv. Fluid from second bottle is used for routine tests while fluid from third bottle is used for bacterial culture etc.
- v. If tuberculous meningitis is suspected, 4th bottle is kept in refrigerator undisturbed to see whether a pellicle or coagulum forms.

**NB: CSF must never be refrigerated (if for bacterial culture as it kills *H. Influenzae*) and should be kept at 37°C.**

#### **Body Effusions (Exudates and Transudates)**

An effusion is fluid which collects in a body cavity or joint. Fluid which collects due to an inflammatory process is referred to as an **exudate** (needs investigations) and that which forms due to a non-inflammatory condition is referred to as a **transudate** (needs no microbiological investigations). Effusions include; pleural, pericardial, synovial, peritoneal, and hydrocele fluids.

### 1.5.2 Pleural and Pericardial Fluids



Main purpose of testing is to ascertain their transudative or exudative nature and to find a causative organism if an infective process is indicated. See sputum sample for list of organisms that can be isolated from pleural samples.

### **1.5.3 Peritoneal Fluid - Ascites**

The common indications for paracentesis are ascites of unknown origin, suspected intestinal perforation, haemorrhage or infarct, infections like tuberculosis, complications of cirrhosis (spontaneous bacterial peritonitis) and suspected intra-abdominal malignant disorders.

### **1.5.4 Joint fluid (synovial fluid)**

Joint fluid cultures are performed to diagnose septic arthritis (most cases of arthritis are NOT infectious; they are due to strain on a joint or immunological diseases).

The three most common causes of septic arthritis are: *Staphylococcus aureus*, *Neisseria gonorrhoea*, and Coagulase-negative staphylococci in patients with joint replacement prosthetics

### **1.5.5 Hydrocele Fluid**

Usually from the sac surrounding the testes. Occasionally *Wuchereria bancrofti* microfilariae and rarely *Brugia* species can be found in hydrocele fluid.

### **1.5.6 Collection of aspiration fluids (effusions)**

- Collection of synovial, pleural, pericardial, peritoneal, or hydrocele fluid is carried out by a medical officer or competent nurse.
- Label each container with the date and the patient's identifiers
- After aspiration, aseptically dispense the fluid into 3 tubes as follows:
  - 5 to 10 ml is in a sterile tube for microbiological examination.
  - 5 ml in anticoagulant (heparin, trisodium citrate or EDTA) for estimation of cell count and protein concentration.
  - 2-3 ml in a plain tube and allowed to clot (normal fluid does not clot).
- If the sample cannot be examined immediately, fluid should be frozen and stored at -70°C until examined.

## 1.6 COLLECTION OF GENITAL SAMPLES

- Indicated for the diagnosis of bacterial sexually transmitted diseases, primarily gonorrhea (GC) or non-gonococcal cervicitis or urethritis (NGU). The most common cause of NGU is *Chlamydia trachomatis*.
- immunological and molecular tests for the diagnosis of chlamydial infections includes (PCR, DNA probes, etc.) .
- Vaginal secretions are also sent to the laboratory for the diagnosis of vaginitis.
- The diagnosis of vaginitis can be made with a wet mount – yeast, trichomonas, bacterial vaginosis (BV), culture – yeast, or Gram stain – yeast and BV.
- Urethritis, cervicitis: *Neisseria gonorrhoeae*, *Chlamydia trachomatis*, Other agents of NGU
- Vaginitis: *Candida albicans*, *Trichomonas vaginalis* and BV

### 1.6.1 Urethral swabs

Possible pathogens; *Neisseria gonorrhoea*, *Chlamydia trachomatis*, and *Trichomonas vaginalis*.

#### Collection of urethral discharge from male patients

- i. Cleanse around the urethral opening using a swab moistened with sterile physiological saline.
- ii. Gently massage the urethra from above downwards.
- iii. Using a swab, collect a sample of discharge.
- iv. Make a smear of the discharge on a microscope slide by gently *rolling* the swab on the slide. This will avoid damaging pus cells which contain the bacteria.

**Note: Very few pus cells may be present if the patient has recently passed urine. Allow 2–4 hours after urination before collecting a samples.**

- v. When culture is indicated (see previous test),  
Collect a sample of pus on a sterile cotton-wool swab.  
If possible, before inserting the swab in a container of Amies transport medium, inoculate a plate of culture medium.
- vi. Label the samples and deliver them to the laboratory as soon as possible.
- vii. Isolation of *N. gonorrhoeae* from urine

#### **Note:**

A rectal swab is also required from homosexual patients. A selective medium is required to isolate *N. gonorrhoea* from a rectal sample.

In acute urethritis, it is often possible to detect *N. gonorrhoea* in pus cells passed in urine, especially the first voided urine of the day (centrifuged to sediment the pus cells).

#### **Cervical swabs and possible pathogens**

**From non-puerperal women:**

*Neisseria gonorrhoea*, *Chlamydia trachomatis* (serovars D-K), *Streptococcus pyogenes*, herpes simplex virus.

**From women with puerperal sepsis or septic abortion:**

*Streptococcus pyogenes*, other beta haemolytic streptococci, *Staphylococcus aureus*, *Enterococcus* species, anaerobic cocci, *Clostridium perfringens*, *Bacteroides*, *Proteus*, *Escherichia coli* and other coliforms, *Listeria monocytogenes*.

**1.6.2 Collection of cervical samples from female patients**

- i. A samples collected from the endocervical canal is recommended for the isolation of *N. gonorrhoeae* by culture. Use a sterile vaginal speculum to examine the cervix and collect the samples.
- ii. Moisten the speculum with sterile warm water, and insert it into the vagina.
- iii. Cleanse the cervix using a swab moistened with sterile physiological saline.
- iv. Pass a sterile cotton-wool swab 20–30 mm into the endocervical canal and gently rotate the swab against the endocervical wall to obtain a samples.
- v. When gonorrhoea is suspected, before inserting the swab in Amies transport medium, if possible inoculate a plate of culture medium. Label the sampless and deliver to the laboratory as soon as possible. Inoculated culture plates must be incubated within 30 minutes.

**1.6.3 Vaginal Swabs**

Vaginal discharge may be due to infection of the vagina or infection of the cervix or uterus.

Pathogens causing vaginal infections include *Trichomonas vaginalis*, *Candida* species, and *Gardnerella vaginalis* with anaerobes.

**1.6.4 Collection of vaginal discharge to detect *T. vaginalis*, *C. albicans* and *G. vaginalis***

Two preparations are required:

**A. Wet preparation to detect motile *T. vaginalis***

- i. Use a sterile swab to collect a samples from the vagina.
- ii. Transfer a sample of the exudate to a microscope slide.
- iii. Add a drop of physiological saline and mix.
- iv. Cover with a cover glass.
- v. Label and deliver to the laboratory for immediate examination

**B. Dry smear for Gram staining to detect *Candida* and examine for clue cells**

Although yeast cells can be seen in an unstained wet preparation, the Gram positive cells and pseudohyphae of *C. albicans* are more easily seen in a Gram stained smear.

- i. Use a sterile swab to collect a samples from the vagina.
- ii. Transfer a sample of the exudate to a microscope slide and spread it to make a *thin* smear.
- iii. Allow the smear to air-dry, protected from insects and dust.
- iv. Label and deliver to the laboratory with the wet preparation.

### **1.6.5 Collection of samples to detect *T. pallidum***

To detect motile *T. pallidum* spirochetes, a samples must be collected before antibiotic treatment.

- i. Wearing protective rubber gloves, cleanse around the ulcer (chancre) using a swab moistened with physiological saline. Remove any scab which may be present.
- ii. Gently squeeze the lesion to obtain serous fluid. Collect a drop on a clean cover glass and invert it on a microscope slide.
- iii. Immediately deliver the preparation to the laboratory for examination by dark-field microscopy

## 1.7 WOUND SAMPLES TO INCLUDE PUS, ABSCESS, TISSUE, ETC.

Indicated for primarily to diagnose skin and soft tissue infections (SSTIs). SSTIs may be caused by a variety of organisms; different organisms depending on how the wound or injury occurred. Fungi, parasites, and viruses are also important causes of certain types of SSTIs.

Community-acquired: *Staphylococcus aureus*, *Streptococcus pyogenes*, *Clostridium perfringens* and other anaerobic bacteria).

Hospital-acquired: *Staphylococcus aureus*, Enteric Gram-negative rods – *E. coli*, *Pseudomonas aeruginosa*, *Acinetobacter* species, and other non-fermenting Gram-negative rods, *Streptococcus pyogenes*, *Clostridium* species and other anaerobic bacteria

### 1.7.1 Collection of Wound samples - General considerations

Samples should be collected by a medical officer or an experienced nurse.

Pus from an abscess is best collected at the time the abscess is incised and drained, or after it has ruptured naturally.

When collecting pus from abscesses, wounds, or other sites, avoid contaminating the sample with commensal organisms from the skin.

As far as possible, a samples from a wound should be collected before an antiseptic dressing is applied.

When pus is not being discharged, use a sterile cotton-wool swab to collect a sample from the infected site.

Immediately after collection, immerse the swab in Amies transport container.

Label the samples and as soon as possible deliver it with a completed request form to the laboratory.

**When myeloma is suspected:** Obtain a samples from a draining sinus tract using a sterile hypodermic needle to lift up the crusty surface over the sinus opening. This method of samples collection has the advantages that the pus obtained is usually free from secondary organisms and the draining granules can usually be seen clearly and removed for microscopic examination. Transfer the pus to a sterile container.

**When tuberculosis is suspected:** Aspirate a sample of the pus and transfer it to a sterile container.

**When the tissue is deeply ulcerated and necrotic** (full of dead cells): Aspirate a sample of infected material from the side wall of the ulcer using a sterile needle and syringe. Transfer to a sterile container.

**Fluid from pustules, buboes, and blisters:** Aspirate a samples using a sterile needle and syringe. Transfer to a sterile container.

**Serous fluid from skin ulcers, papilloma, or papules, that may contain Treponema:** Collect a drop of the exudate directly on a *clean* cover glass and invert it on a *clean* slide. Immediately deliver the samples to the laboratory for examination by dark-field microscopy.

**Caution:** Samples from patients with suspected plague or anthrax are highly infectious. Label such samples HIGH RISK and handle them with care.

In a health centre for dispatch to a microbiology laboratory

Collect the samples using a sterile cotton-wool swab.

Insert it in a container of Amies transport medium, breaking off the swab stick to allow the bottle top to be replaced tightly.

#### **In a hospital with a microbiology laboratory**

- i. Using a sterile technique, aspirate or collect from a drainage tube up to 5 ml of pus.
- ii. Transfer to a leak-proof sterile container. When the material is aspirated fluid from a pustule, transfer the fluid to a sterile, leak-proof container. Stopper, and seal in a leak-proof plastic or metal container.

**Note: It is not possible to transport exudate from a suspected treponemal ulcer because the *Treponema* remain motile for only a short time.**

Make a smear of the material on a clean slide (for Gram staining) and allow to air-dry in a safe place.

Heat-fix the smear.

**Caution: Do not make a smear for transporting when the samples is from a patient with suspected anthrax.**

Send the samples with a completed request form to reach the microbiology laboratory within 6 hours.

### **1.8 COLLECTION OF THROAT AND NASAL SWABS**

Throat cultures are performed to diagnose streptococcal pharyngitis (infection with *Streptococcus pyogenes* (Group A streptococci)). The most common causes of pharyngitis (sore throat) are viruses, which cause over 75- 80% of all cases. Of the bacteria that cause pharyngitis, Group A streptococci is the major cause and therefore, with few exceptions the only bacteria that is reported from a throat culture is *Streptococcus pyogenes*.

Exceptions include:

*Corynebacterium diphtheria* which in areas of the world where vaccination is prevalent, is a rare cause of pharyngitis

*Neisseria gonorrhoea* can cause pharyngitis, however many pharyngeal infections with *N. gonorrhoea* are mild or asymptomatic.

If the physician suspects either of these two organisms, he/she must let the laboratory know because the isolation of either requires special culture techniques.

#### **Throat Swabs**

Throat swab cultures are to be taken under direct vision with good light.

Areas of exudation, membrane formation, any inflammation or if not seen then tonsillar crypts are the sites of choice.

#### **Nasal swabs**

Nasopharyngeal swabs are better taken by treating physician/surgeon himself.

For recovery of viral agents, washings are collected after gargles with nutrient broth by the patient.

Nasal Sample for *Mycobacterium leprae*

The nasal sample for *M. leprae* can be taken as follows:

#### **1.8.1 Nasal swab**

- i. Make the patient sit with his head bent backwards but facing the light.
- ii. Insert and repeatedly rotate the swab into one of the nasal cavities, against upper part of the nasal septum.
- iii. Make 2-3 evenly spread smears.
- iv. Air dry the slides, wrap in a paper and send to the laboratory.

### **1.8.2 Nasal washings and nasal blow**

- i. Make the patient sit.
- ii. Place a few drops of sterile saline in the nose.
- iii. After 3 min, ask the patient to blow hard his nose on a small sheet of plastic or cellophane. (This plastic or cellophane can be given to the patient to take it home and ask him to blow hard onto the sheet, the following morning, soon after waking and before washing.
- iv. The patient can bring it directly to the laboratory).
- v. Transfer some of the mucus pieces from the washing to a slide with a clean wooden stick and make thin smear.
- vi. Air dry slide and send it to the testing area

### **1.8.3 Collection of Nasopharyngeal Swabs**

Assemble equipment for Nasopharyngeal swab collection and PPEs for prevention of infections.

- i. Label the VTM with required information and fill the register and all necessary forms with all necessary information.
- ii. Remove the swab from the package. Do not touch the soft end with your hand or anything else.
- iii. Insert the nasopharyngeal swab into the nasopharynx region.
- iv. Leave in place for a few seconds.
- v. Slowly remove swab while slightly rotating it.
- vi. Break the applicator's stick end and put tip of swab into ATM containing vial VTM

## **1.9 COLLECTION OF OROPHARYNGEAL SWABS**

Assemble equipment for oropharyngeal throat swab collection and prevention of infections.

- i. Label the VTM with required information and fill the register and all necessary forms with all necessary and correct information.
- ii. Remove the swab from the package. Do not touch the soft end with your hand or anything else.
- iii. Have the patient open his/her mouth wide.
- iv. Insert swab in the area of tonsils.
- v. Use tongue depressor if the patient is not able to resist gagging and closing the mouth while the swab touches the back of the throat near the tonsils.
- vi. Rotate swab to obtain adequate sample
- vii. Break the applicator's stick end and put tip of swab into vial containing VTM

## **1.10 COLLECTION OF SKIN SMEARS**

- i. Ensure all required material and supplier are in place.
- ii. Ask the patient to sit on the prepared chair at phlebotomy.
- iii. Confirm the identity of the patient by asking his/her name and compare with name written on the request form.
- iv. Clearly explain to patient what you want to do and ask for verbal consent
- v. Select the site, you should take a smear from two sites only; One ear lobe and One active lesion

### **1.10.1 Sample from ear lobe**

- i. Clean the skin at the smear site with swab and let it air dry.
- ii. Pinch the skin firmly between your thumb and forefinger
- iii. Make an incision in the skin about 5mm long and 2mm deep. Keep on pinching to make sure the cut remains blood less
- iv. Turn the scalpel 90° and hold it at right angle to the cut
- v. Scrap inside the cut once or twice with side of the scalpel to collect tissue fluid and pulp (there should be no blood in the sample as this may interfere with staining and reading of the slide
- vi. Stop pinching the skin and absorb any bleed with dry cotton swab
- vii. Spread the material scrapped from the incision on to the slide, ensure you spread it evenly with the flat of the scalpel making 8mm diameter
- viii. Clearly label your slide with patient ID similar to that appearing on patient request form

### **1.10.2 Sample from active lesion**

- i. Rub the scalpel with cotton wool drenched with alcohol.
- ii. Pass the blade through the flame of the spirit burner for 3-4 seconds and let it to cool without touching anything
- iii. Select the most active looking lesion (active means lesion that are raised and reddish in colour)

## **1.11 SPUTUM SAMPLES**

Sputum cultures are performed to diagnose infections such as pneumonia and pulmonary tuberculosis that is caused by *Mycobacterium tuberculosis*.

Bacteria associated with Community-Acquired Pneumonia (CAP):

- *Streptococcus pneumoniae* – most common bacterial cause of CAP
- *Haemophilus influenzae*
- *Moraxella catarrhalis*
- *Staphylococcus aureus* - particularly following a viral infection such as influenza
- *Klebsiella pneumoniae* – particularly in individuals with chronic conditions such as alcoholism



- *Mycoplasma pneumonia*\* – particularly in young individuals in closed quarters
- Bacteria associated with Hospital-Acquired Pneumonia:
- *Streptococcus pneumoniae*
- Enteric Gram-negative rods such as *E. coli*, *Klebsiella*, *Enterobacter*, *Citrobacter*, and *Serratia*
- *Staphylococcus aureus*
- *Pseudomonas aeruginosa*
- *Acinetobacter* species
- *Haemophilus influenzae*

### **1.11.1 Sputum Collection Procedure**

1. Label the sample container on the body of the container, not on the lid and fill out the sputum examination request form.
2. Instruct the patient and demonstrate how she or he can produce and collect good sputum;
  - a. Access to a well ventilated place (outside the laboratory working area),
  - b. Mouth wash (rinsing with water),
  - c. Breathe in deeply 2-3 times, and breathe out hard each time.
  - d. Cough deeply from the chest and collect the sputum into the container.
  - e. Opening and closing the sputum container so as there are no leaks or smearing on the exterior of the container.
  - f. Hand wash steps
3. Emphasize the need for the patient to supply the most useful sample, the normally thick, yellowish (sometimes blood-streaked), purulent material brought up from the lungs after a deep, productive cough.
4. Emphasize that saliva produced by spitting is not sputum. However, if the only sample the patient can produce is salivary, do submit it to the laboratory as it can still yield useful information.
5. Encourage the patient to bring the collected sample back to the unit as quickly as possible.
6. For *M.tuberculosis* culture, a series of three fresh, early morning samples (5-10 ml) are collected and kept in the refrigerator. If amount is less, the patient is advised to collect 24 h sputum or until 50 ml is obtained.
7. *M.tuberculosis* can be recovered from the gastric contents in infants, debilitated patients and those who are unable to cooperate in the collection of sputum. This can be obtained by gastric aspiration performed as an indoor procedure.
8. Gastric washings are better collected early in the morning, in fasting state. These are neutralised soon after collection by N/10 NaOH.

## **1.12 COLLECTION AND TRANSPORT OF SAMPLES FOR FUNGAL CULTURE**

### **1.12.1 Purpose**

The proper collection of Samples and their rapid transport to the clinical laboratory are of major importance for the recovery of fungi. In many instances, Samples not only contain the etiologic agent but also contain contaminating bacteria or fungi that will overgrow some of the slower-growing pathogenic fungi.

### Materials

Sterile sample collection containers (screw-capped, plastic, disposable), screw-cap tubes, transport media, blood culture bottles

70% alcohol, syringe and needle, forceps

Requisition forms, biohazard sample bags

### Samples

Samples submitted for fungus cultures may come from either sterile or non-sterile body sites.

Samples include cerebrospinal fluid (CSF), blood, bone marrow, pleural fluid, peritoneal fluid, joint fluid; tissue biopsies and fine needle aspirates from body sites such as the lung, liver, brain, lymph nodes.

sputum, tracheal aspirate, Broncho alveolar lavage fluids; skin, nails and hair samples; midstream urine; superficial wound swabs; throat, mouth, or nasopharynx; ear material; vaginal or cervical material; and faeces.

- **Procedure**

1. Collect Samples aseptically and place in sterile, leak-proof containers, collect vaginal, ear, throat, and cervical Samples in swabs. Dried out swabs and 24 hour collections of any sample are not acceptable.
2. Blood for fungal cultures are directly inoculated into special culture bottles. The medium should be obtained from the laboratory prior to collection.
3. the sample should be collected before an antifungal agent is administered.
4. Deliver the sample to the laboratory within two hours.
5. Submit Samples with appropriate test request form that indicate type of fungal culture requested:
  - a. Dermatophyte culture for hair, skin, and nail Samples
  - b. Rule-out *Candida* culture for vaginal, urine, skin and throat Samples
  - c. Fungal blood culture
  - d. Complete fungal culture

### Appendix 1: Guidelines for Collection of Samples for Fungal Cultures (Site-specific)

Collection Guideline and Minimum Volume	Transport** Local / distal	Comments
<b>Abscess/drainage/wound:</b> Aspirate sample and transport in a syringe without needle or place in a sterile screw-cap container.	≤2 h, RT ≤24 h, RT	Samples may also be collected using aerobic swab transport system (least recommended). Sample base of lesion and abscess wall.

Collection Guideline and Minimum Volume	Transport** Local / distal	Comments
<b>Blood:</b> Collect as for bacterial cultures; inoculate 10 ml Samples into blood culture bottles (commercial). (Note: The amount of blood inoculated into the bottle depends on the amount of media in the bottle.)	≤2 h, RT ≤24 h, RT	Automated blood culture systems
<b>Bone marrow:</b> Inoculate Samples onto culture medium or blood culture bottles (commercial) for automated blood culture system.	≤15 min RT ≤24 h, 4°C	Lysis centrifugation device may be used; 0.5 ml to 3 ml of bone marrow in a green top (heparin) tube or 5 ml in a yellow top tube (heparin)
<b>CSF:</b> Collect a minimum of 2 ml in a sterile container.	≤15 min RT or 30°C ≤24 h, RT	Never refrigerate CSF; aspirate or biopsy of brain abscess may be refrigerated
<b>Ear, external:</b> Collect as for bacterial culture; use transport swab	≤2h, RT ≤24 h, 4°C	
<b>Eye, Corneal scrapings:</b> Inoculate directly onto media and prepare slides for staining. Agar plates are inoculated by lightly touching both sides of the spatula in a row of separate “C” streak marks.	15 min RT ≤24 h, RT	Contact the laboratory to obtain medium prior to corneal scraping procedure.
<b>Eye, conjunctiva:</b> Collect sample in aerobic transport swab medium.	≤2 h, RT ≤24 h, RT	Sample both eyes even if one is uninfected. The uninfected eye can act as a control to compare against agents isolated from the infected eye.
<b>Hair/Nails:</b> Disinfect area with 70% alcohol before collection of Samples. <b>Hair:</b> After selecting infected area, remove at least 10 hairs with shaft intact, and scrape scalp scales if present. <b>Nails:</b> Scrape infected nail area, or clip infected nail.	≤72 h, RT ≤72 h, RT	Place Samples in dry container or envelope. Humidity in a closed sample transport system may cause the sample to be overgrown by bacteria

Collection Guideline and Minimum Volume	Transport** Local / distal	Comments
<p><b>Respiratory sites:</b> Collect 3 early morning sputa resulting from a deep cough; Collect BAL, trans tracheal aspirate, bronchial washings, and induced sputum. Collect &gt;1 ml. Transport Samples in a sterile screw-cap container.</p>	<p>≤2 h, RT ≤2 h, 4°C</p>	<p>24-hours sputum collections are not acceptable for fungal culture.</p> <p>Short survival time for thermally dimorphic pathogens</p>
<p><b>Respiratory sites:</b> Sinuses Surgical removal of sinus contents. Collect sample in sterile, moist gauze. Transport sample in a sterile screw-cap container</p>	<p>≤15 min RT ≤24 h, RT</p>	<p>Maxillary and ethmoid sinuses are the most common sites. Use no bacteriostatic saline solution to moisten the sample.</p>
<p><b>Respiratory sites:</b> Oral Swab active lesions in aerobic transport swab medium.</p>	<p>≤2 h, RT ≤24 h, RT</p>	
<p><b>Skin/intertriginous areas:</b> Disinfect area with 70% alcohol; scrape surface of skin at margin of lesion with a scalpel or end of a microscope slide. Place sample in clean dry container or envelope.</p>	<p>≤72 h, RT ≤72 h, RT</p>	<p>Humidity in a closed sample transport system may cause the sample to be overgrown by bacteria.</p>
<p><b>Sterile body fluids:</b> pericardial, peritoneal, pleural, synovial Collect a minimum of 2 ml in a sterile screw-cap container. May use blood culture bottles for yeasts.</p>	<p>≤15 min RT ≤24 h, 4°C</p>	<p>In general, the more fluid obtained for culture, the better the chance of isolation for any fungal pathogen.</p>
<p>Submission of stool Samples for routine fungal culture is discouraged. Many <i>Candida</i> spp. are part of the normal stool biota, and anything that disrupts the normal gastrointestinal tract biota, such as diet or use of antibiotics, can yield a predominance of yeast when stool is cultured. Neither colonization with yeast nor a predominance of yeast indicates invasive disease with <i>Candida</i>.</p>		

Collection Guideline and Minimum Volume	Transport** Local / distal	Comments
If invasive disease of the gastrointestinal tract is suspected, a colonoscopy and tissue biopsy should be performed.		
<b>Tissue/biopsy Samples:</b> Collect tissue and transport in sterile screw-cap container with a small amount of no bacteriostatic saline to prevent drying.	≤15 min RT ≤24 h, RT	Never transport in formalin.
<b>Urine:</b> First morning clean-catch urine in sterile screw-cap cup; Catheterized sample in sterile screw-cap cup; collected in a sterile screw-cap cup following prostatic massage.	≤2 h, RT ≤2 h, 4°C	24-hur urine collections and Foley catheter urine Samples are not acceptable; Patients with blast mycosis or cryptococcosis may have prostatic infection.
<b>Vagina:</b> Collect sample in aerobic transport swab medium.	≤2 h, RT ≤24 h, RT	Primarily for refractory vaginal candidiasis

### 1.13 COLLECTION OF SAMPLES FOR CYTOLOGY

#### Fixative

Two types of smears are used for cytological examination depending on the preferred method of staining.

Usually wet-fixed smears are preferred to air-dried smears. Wet fixed smears are prepared by immediately fixing the slide without allowing it to dry. The fixatives recommended are a mixture of equal parts of ether and 95% ethyl alcohol, formal alcohol or 95% ethyl alcohol alone. Not less than 15 min are required for adequate fixation though slides may remain in the fixative for 7-10 days without deterioration. Coplin jars made of glass or plastic are commonly used as containers for fixative. Papanicolaou's and H&E stains are commonly used on wet-fixed smears.

#### Respiratory Tract:

##### Sputum

A fresh early morning sample produced by a deep cough should be collected and brought to the laboratory immediately without any fixation. If it is not possible to transport unfixed material to the laboratory, the sputum should be prefixed by asking the patient to expectorate into a wide mouthed small jar half filled with 70% ethyl alcohol. In case of peripheral laboratories where cytology facilities are not available, fresh sputum should be examined grossly for tissue fragments and blood tinged areas. Smears from these areas and other randomly sampled areas should be prepared and

fixed immediately (wet-fixed) in 95% ethyl alcohol. After fixation for 20 min these slides can be dried and transported to referral laboratory for reporting.

### **Bronchial Aspirates, Washings and Brushings**

Aspirates and washings collected during bronchoscopy may be centrifuged and smears prepared from the cell button. Direct smears can also be made and fixed in 95% ethyl alcohol. Direct smears should be prepared from bronchial brushings and wet-fixed in 95% alcohol. Alternatively, they can be processed like aspirates and washings.

### **Broncho alveolar Lavage (BAL)**

BAL involves the infusion and re-aspiration of a sterile saline solution into the air passages. This fluid should be submitted as such immediately to the laboratory. If delay in transportation is expected, equal quantity of 95% ethyl alcohol should be added.

### **Urinary Tract:**

#### **Urine**

Freshly voided urine is the sample of choice in male patients. The first morning sample should be avoided as the urine has been collecting in the bladder overnight and the cells have usually degenerated. In female patients catheterised urine is the preferred sample. Approximately 50-100 ml of urine should be collected in an equal amount of 50% ethyl alcohol. If possible the patient should be sent to the laboratory for collection of a fresh sample.

### **Washings and Brushings of Ureter and Renal Pelvis, Bladder Washings**

All washings should be collected in an equal amount of alcohol for fixation. Brushings may also be added to alcohol for fixation. Alternatively, direct smears may be prepared and wet fixed in an alcoholic fixative.

### **Pleural, Pericardial and Peritoneal Fluids**

Fluid should be collected in a clean, dry container, which need not be sterile, and should be sent to the laboratory as soon as possible. If it is not possible to send the fluid immediately, it should be stored in a refrigerator at 4°C and not allowed to freeze. The sample can be preserved at refrigerator temperature for several days. In case of small peripheral laboratories without cytology facilities, smears should be prepared after centrifugation. Both wet-fixed and air-dried smears of the sediment, labelled as such should be submitted to the referral laboratory.

### **CSF**

Cerebrospinal fluid should be collected in a clean container and transported immediately to the laboratory for processing. If delay in transportation of more than a few hours is expected equal amount of 50:50 alcohol ether mixture, or 95% ethyl alcohol may be added.

### **Alimentary Tract**

Brush and wash samples may be collected from oesophagus, stomach, lower bowel and rectum. Brush smears should be prepared immediately by rolling on a clear glass slide. Five to six such smears may be wet fixed in alcohol for Papanicolaou's staining. A few air-dried smears may also be prepared. These should be labelled as such and submitted for cytological examination. Wash samples from stomach must immediately

be neutralised with N/10 sodium hydroxide (pH up to 6.0) and centrifuged rapidly in ice-cold siliconized tubes. Smears are prepared from the deposit in the same manner as mentioned above. Wash samples from lower bowel are also concentrated in the same way by centrifuging in ice-cold siliconized tubes and smears prepared.

## **Female Genital Tract**

### **Cervical Smear:**

1. Used to obtain a representative sample from the squamocolumnar junction (transformation zone), using an Ayre's spatula or similar device.
2. Having exposed the cervix using a bivalve speculum a circumferential sample is obtained by rotating the spatula through 360°, thus obtaining cells from the entire junctional zone.
3. If the smear does not show endocervical cells, an additional smear may later be obtained from the endocervical canal by using a cotton-tip applicator or endocervical cytobrush.
4. By using a wooden spatula, place the obtained sample on a glass slide and spread smoothly down the length of the slide. Immediately, fix the slide by placing it in 95% alcohol for a minimum of 15 min or by using an aerosol spray fixative.
5. After fixation the slide is allowed to dry and sent to the laboratory with a complete request form.
6. Slide identification and labelling must be ensured at all times.
7. Alternatively, a sample may also be collected from the vaginal pool in the posterior fornix with the help of a pipette.
8. Few drops of fluid are expressed onto a slide, spread and fixed in the same way as above.
9. The advantage of this sample is that it contains cells from the entire female genital tract however the disadvantage is that the cells are dead and desquamated and may show degenerative **changes, which are difficult to interpret.**

### **Vaginal Smear**

Samples for hormonal evaluation are taken from the lateral vaginal wall. If this is not possible, posterior fornix pool sample may be used. The samples should be taken by lightly dipping the applicator in the secretions avoiding forceful scraping. The smears are prepared, wet fixed immediately in the same manner as cervical smears, dried and submitted to the laboratory.

## **Breast**

### **Nipple discharge**

A few drops should be expressed by pressing the sub areolar region. The drops are touched on to a clean glass slide and spread with the help of another slide. Smears should be wet fixed in alcoholic fixative and submitted.

### **FINE NEEDLE ASPIRATION (FNA) BIOPSY**

This technique can be used to sample superficial and subcutaneous lesions in breast, thyroid, lymph node, salivary gland and superficial abdominal masses. It can also be

used in deep visceral lesions with the help of radiologists using fluoroscopy, computer assisted tomography, angiography and ultrasonography to localise the lesions.

### **Procedure for FNA:**

1. Proper clinical history should be taken in establishing diagnosis.
2. Explain and assure the patient about the procedure.
3. Obtain a disposable syringe with 21-25 gauge needle (5-10 ml) syringe.
4. Thoroughly cleaned the area with a spirit swab.
5. Introduce the needle into the mass, create negative pressure by retracting the plunger and prob the mass is in several directions (Figure 1).
6. Prior to withdrawal of needle, release the plunger to allow equalisation of pressure.
7. Apply a cotton swab for few min to stop the bleeding.

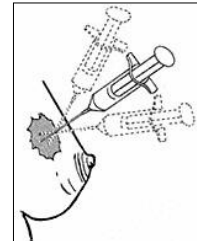

**Figure 1: Fine needle biopsy technique**

### **Slide Preparation:**

1. After aspiration, detach the syringe from the needle and fill it with air.
2. Reattach the syringe to the same needle and push the plunger to gently express the material onto glass slides.
3. This step can be done once or twice.
4. By using another slide, gently spread the materials on the slide. You can use the opposite surfaces of the two slides (one slide containing aspirated material and another clean slide) for smearing.
5. Allow the slides to air dry or fix them in solution containing ether and alcohol in equal proportions or 95% alcohol.
6. Stain the slides by either of the cytological stains ((Papanicolaou (PAP), Haematoxylin and Eosin (H&E), Leishman and modified Giemsa stains)).

### **Collection of semen**

- a. The period of abstinence, date and time of collection and interval of time between actual collection and laboratory analyses should be recorded on the worksheet.
- b. The sample must preferably be collected after 3-day abstinence, but not longer than 7 days.
- c. The entire sample should be obtained by masturbation into a sterile glass or plastic container with a screw top.
  - NOTE: Coitus interruptus is not a reliable means of semen collection, because the first portion of the ejaculate, which contains the highest number of spermatozoa, may be lost. Moreover, there may be cellular and bacteriological contamination of the sample and the low pH of the vaginal fluid could adversely affect sperm motility.
- d. The sample should preferably be collected on site; if this is not possible, the sample must be delivered to the laboratory within 30 minutes to 45 minutes of collection. During this period, the sample should be kept at body temperature.



- e. Ordinary latex condoms and containers with rubber stoppers must never be used as these interfere with the spermatozoa viability and motility.

## References

1. Medical Laboratory Manual for Tropical Countries, vol 1, Monica Cheesbrough. 1998
2. Patricia T. Kent, B.S., George P. Kubica. 1985. Public Health Mycobacteriology; A guide for the level III Laboratory. *U.S Depart. Of Health, Centers for Disease Control.*
3. Bobby E. Strong, M.S., George P. Kubica. Isolation and Identification of Mycobacterium tuberculosis; A guide for the Level II Laboratory. *US. Dept. of Health, Division of Human Services, Centers for Disease Control.*
4. National Standards for Medical Laboratory Guideline, Tanzania; October 2017
5. Practical Laboratory Manual by Jane Carter and Orgenes Lema.
6. Basic Laboratory Method in Medical Parasitology-WHO 1991.
7. District Laboratory Practice in Tropical Countries by Cheesbrough.
8. Manual of Clinical Microbiology. American Society for Microbiology (ASM), Washington D.C., USA. 10th edition, 2011.
9. The African Field Epidemiology Network: Outbreak Investigation Laboratory Guidelines. DC, USAID, AFENET.
10. Guide for National Public Health Laboratory Networking to Strengthen Integrated Disease Surveillance and Response. WHO, CDC, USAID. Brazzaville, Republic of Congo. 2008

## **1.14 SAMPLE FOR HISTOPATHOLOGY**

### **General Considerations**

1. Container must be several times larger than the sample.
2. It should be wide mouthed and flatbottomed.
3. It should have a screw cap.
4. The plastic container is always preferred over the tin jar.
5. Container should have a label with name of the patient, bed number, ward and nature of sample.
6. The surgical sample should be washed with tap water to remove extra blood whenever possible.
7. The large samples may be incompletely sliced with sharp knife for better fixation.
8. The accompanied request form should have name, age, ward, site of biopsy and brief clinical history.

### **FIXATIVES**

- In routine, 10% formal saline is an appropriate fixative. It is prepared by diluting one part of 40% formalin in nine parts of physiological saline. Pure formalin (40%) should not be used because it hardens the sample.
- Samples for frozen section are sent in physiological/isotonic saline.
- Bone marrow trephine biopsy is fixed in Zenker's solution/formalin or any suitable fixative.
- Post-mortem samples are fixed and transported in 10% formal saline.
- The quantity of fixative should be 3-4 times the size of the surgical sample.
- In special situations always consult pathologist about the fixative to be used.

### **Renal Biopsy**

The sample of renal biopsy for histopathological examination should be collected in 10% formal saline. The request form should contain all the relevant clinical information and results of laboratory investigations. The sample of renal biopsy for immunofluorescence should be submitted fresh in normal saline.

### **Liver Biopsy**

The liver biopsy sample should be collected in 10% formalin/formal saline. Request form should mention the reports of LFTs and hepatitis markers tested besides the relevant clinical information. Liver biopsy sample for the diagnosis of storage disorders should be collected in absolute alcohol.

### **Bone Sample**

Bone sample should be collected in 10% formal saline. Information regarding age, sex of the patient, site of biopsy, clinical history and x-ray with radiologists opinion are required for reporting on bone samples and should accompany the sample.

### **Sample for Immunohistochemistry and Tumour Markers**

Samples should be collected in 10% formal saline. If the case has been reported from AFIP initially, then AFIP report No. is also required. If the case is reported by some other laboratory, then all the slides along with paraffin embedded blocks and the histopathology report are required for immunohistochemistry and tumour markers.

***Sample for Oestrogen and Progesterone Markers***

These markers are carried out on paraffin blocks. Paraffin blocks along with previous slides and report are required if the case has been reported from some other laboratory.

## CHAPTER 2: PARASITOLOGY

---

### 2.1. PROCEDURE FOR MALARIA RAPID TEST (MRDT)

#### 2.1.1. Purpose

This procedure provides instructions for In vitro qualitative screening test for detection of malaria parasites (*P. falciparum*, *P. vivax*, *P. ovale* and *P. malariae*) in whole blood

#### 2.1.2. Scope

This procedure applies to all Health Laboratory Practitioners who works in parasitology section on performing MRDT test.

#### 2.1.3. Responsibility

Head of section is responsible to ensure implementation and competence assessment for all staff that will perform this test

#### 2.1.4. Principle

Test is based on principle of immune-chromatography in which nitrocellulose membrane is pre-coated with two monoclonal antibodies as two separates lines. One monoclonal antibody (test line PAN), is PAN specific to lactose Dehydrogenase (pLDH) of the plasmodium species (*plasmodium falciparum*, *P. vivax*, *P. ovale* and *P. malariae*). And the other line (test line pf) consist of monoclonal antibody specific to histidine rich protein 2 (HRP2) of plasmodium falciparum. When the test sample along with assay diluent flows through intercellular membrane, monoclonal antibody conjugated with colloidal gold which are PAN specific to pLDH and falciparum specific for HRP2 binds to plasmodium antigen released from lysed blood sample. These antigen –conjugate complex moves through the nitrocellulose membrane and binds to corresponding immobilised antibody at test lines, which leads to the formation of colour band/bands indicating reactive results. The control band will appear irrespective of reactive or non-reactive sample.

#### 2.1.5. Sample Requirements

Whole blood from EDTA/Finger prick

#### 2.1.6. Equipment

Timer

#### 2.1.7. Materials

Gloves, Test kit, Laboratory Coat, and

### **2.1.8. Storage and Stability**

MRDT sample should be tested within 1 hour after collection if not possible stored at 2-8°C for 7 days.

### **2.1.9. Safety**

- i. All personal protective equipment (PPE) must be worn when performing this procedure.
- ii. All Samples must be regarded as potentially infectious.
- iii. Refer to National infection prevention and control Guidelines (IPC) f

### **2.1.10. Calibration**

Not Applicable

### **2.1.11. Quality Control**

Process known positive and negative blood sample daily before performing patient samples.

### **2.1.12. Procedure Steps**

Follow the actions described below for sample collection step-by-step.

- i. Allow all kit components and sample to room temperature prior to testing
- ii. Remove the test device from the foil pouch; place it on a flat, dry surface.
- iii. Label the test device with the patient identification number/name
- iv. Transfer 5µl of whole blood collected in an inverted cup/special capillary provided into sample well by touching sample pad. (see manufacture instruction)
- v. Add 4 drops of assay diluents into the squire assay diluents well. (See manufacture instruction)
- vi. Read the result within 15 min. (Do not interpret after 30 min) and read result. (See manufacture instruction).

### **2.1.13. Biological Reference Intervals**

Not Applicable

### **2.1.14. Interpretation and Reporting of Results**

- **Negative**

The presence of one colour band (“C” Control line) within the result window indicates a negative result.

- **Positive**

“C” and “P. falciparum” the presence of two coloured bands (“Pf” test line and “C” control line) within the result window no matter which band appears first, indicate P.F positive result.

- **Positive**

“C”, “P.f” and “Pan” the presence of three colored band (“Pf”, Pan “Test line and “C” Control line) within the result window no matter which band appears first, indicate P.F positive or mixed infection of P.F and P.V or P.M or P.O

- **Invalid result**

If no coloured band appear, at control line “c” within stipulated time then the result is invalid.

#### **2.1.15. Limitations of the procedure and sources of error**

Test kit cannot detect malaria antigen if parasites are less than 100. The test is limited to detect HRP2, an antigen to Malaria Plasmodium species that may persist after treatment or passed P. falciparum infection.

#### **2.1.16. Performance Characteristics**

Refer to package insert

#### **2.1.17. Supporting Documents**

Sample collection manual

#### **2.1.18. References**

Manufacturer inserts

## **2.2. PROCEDURE FOR MALARIA MICROSCOPY**

### **2.2.1 Purpose**

This procedure provides instructions for the examination of malaria parasite to diagnose and monitor treatment outcome of malarial infection.

### **2.2.2 Scope**

This procedure is used during examination of malaria parasites at the Laboratory using Microscopy.

### **2.2.3 Responsibility**

Qualified and trained health Laboratory Practitioners are responsible for performing this test procedure

The Head of Parasitology unit is responsible for ensuring the effective implementation and maintenance of this procedure.

### **2.2.4 Principle**

#### **Giemsa stain**

Giemsa stain is a *Romanowsky* stain contains methylene blue which is basic stain and eosin is acidic stain, the malaria parasites has DNA in the nucleus which is basic in nature and RNA in the cytoplasm is acidic in nature, during staining the reactions takes place whereby acidic part of a parasite will pick-up basic part of the stain and the basic part of the parasite will pick-up the acidic part of the stain, that's why the nucleus of the parasite will show red color and the cytoplasm will stain bluish. Malaria parasites are identified by microscopic examination of thick or thin blood films stained with Giemsa. Thick blood films are used for detecting parasites, thin blood films are used for more detailed morphological examination and for determining parasite species. Thick blood films consist of several layers of blood cells, so that a large volume of blood is examined. The thick film staining technique ruptures red cells, leaving white cells and parasites intact. The thin film staining technique preserves the morphology of blood cells and malaria parasites.

### **2.2.5 Sample Requirements**

Whole blood collected in EDTA tube is required

Blood slides

### **2.2.6 Equipment**

Hot plate, Tally counters or differential counter, Microscope, Timer, Weighing scale, and PH Meter

### **2.2.7 Maintenance**

To increase the life-span of microscopes, preventive maintenance, including cleaning the objectives and replacing parts as necessary, should be part of routine internal QC and must be properly done and documented. Microscopes should be covered when not in use to avoid exposure to dust, and proper precautions must be taken in humid areas to avoid fungal growth on the lenses and in the microscope. Also Hot plate, Tally counter, Timer, weighing scale and PH meter should be maintained as per manufacture instructions.

### **2.2.8 Materials**

- High-quality immersion oil should be used according to the manufacturer's recommendations.
- High-quality microscope slides, free of surface abrasions, preferably have a frosted end for labeling and purchased from a reputable supplier should be used.
- 10% alcohol-based Giemsa stain,
- markers, lancets, syringes, needles, Vacutainer-type needles, alcohol swabs, lens-cleaning solution, lens-cleaning tissues, buffer tablets, pH calibration solutions, cotton-wool, gloves, safety glasses (including the over-spectacle type), filter paper and glycerol. gloves, sharps, boxes, gowns and detergents, and slide boxes.

### **2.2.9 Storage and Stability**

Unstained blood slides should be stored at 2-8 c for 3 months

Stained blood slides should be stored at room temperature for 3 months on slide boxes.

### **2.2.10 Safety**

Adhere to safety precaution as stated in safety manual/IPC guideline

All personal protective equipment(PPE) should be worn when performing procedure

All samples should be regarded as potential infectious

### **2.2.11 Calibration**

Calibration of PH meter and weighing scale should be done once per year. Maintenance of microscopes should be done as planned.

### **2.2.12 Quality Control**

QC slides should be used to check the quality and performance of the Giemsa stain, Microscope and Laboratory personnel. Malaria-positive and negative blood should be used to prepare QC thick and thin films. Before examining patient slides, the QC slides should be checked first, If the QC slides are satisfactory, the patient slides can be examined. Slides must be selected regularly for cross-checking, either by sending them to a crosschecking center or during routine supportive supervisory visits.



### **2.2.13 Procedure Steps**

#### ***Preparation of thick and thin blood film***

- i. Prepare both thick and thin film on the same microscope glass slide.
- ii. Label the slides with the unique patient ID including the date of examination.
- iii. Put Slide card for making thin and thick blood films, showing size of blood drops and area of slide to cover for a thin film and thick film
- iv. Put the microscope glass slide on the slide card for thick and thin film
- v. Pipette 2 $\mu$ l of blood and pour it on the smallest circle on the slide card
- vi. Place the spreader in front of the 2 $\mu$ l drop of blood at a 30 $^{\circ}$ - 45 $^{\circ}$  angle. Use a clean microscope slide with a smooth edge as a spreader.
- vii. Pull back the spreader and hold until the blood evenly spreads along the width
- viii. Push the slide forward in a smooth continuous motion
- ix. Avoid hesitation or a jerky motion when spreading the blood
- x. Pipette 6 $\mu$ l of blood and pour on the large circle on the slide card.
- xi. Using another slide, spread the drop of blood within the confined area to make a thick film.
- xii. Put the slide films on the slide rack and allow it to dry.
- xiii. Fix the thin smear for one second by either spraying or dipping into absolute methanol.
- xiv. Air dry the slides on a slide rack with the fixed thin film facing down

#### ***Preparation of Giemsa Stock Solution (500ml) from Giemsa powder***

- i. Measure and dissolve 3.8g of Giemsa powder in 250ml of methanol
- ii. Measure 250ml of glycerol and add to the solution above
- iii. Ripen the stock solution by placing in direct sunlight for about 1 week or place in water bath of temperature 56 $^{\circ}$ C and shake at interval.
- iv. Filter the stock solution before storing in a cool dry place with label and date of preparation

#### ***Preparation of 10% Giemsa stain from Giemsa Stock solution***

- i. Add 1 part of stock solution to the 9 parts of 7.2 buffer solution
- ii. Prepare 30ml of 10% working giemsa solution as follows: 3mls of Giemsa +25ml of buffered water PH of 7.2
- iii. Mix and transfer to a clean capped leakproof bottle
- iv. Label and keep in a dry place

#### ***Staining of blood films***

- i. Arrange the slides on a staining rack with the sample side facing up
- ii. With an aid of a disposable pipette, Flood the films with 10% Giemsa solution and leave to stain for 15 minutes.
- iii. Decant the Giemsa and wash in buffered water at pH 7.2
- iv. Clean the back of each slide with cotton wool or gauze
- v. Air dry the slides

## **Examination of the blood films**

- i. Place a drop of immersion on the thick film
- ii. Place the slide on the microscope stage
- iii. Swing the X10 objective into position and bring the film into focus using the coarse adjustment.
- iv. Use the X10 and X40 objectives to check quality of the slide(s) before reading and reporting;
- v. Swing the x 100 oil immersion objective into position and focus using the fine adjustment
- vi. Choose the correct smear reading pattern either Horizontal, start from up right to left or Vertical, start from upright down.
- vii. Systematically, Examine the thick film.
- viii. If you do not see any parasites, continue examining the whole film.
- ix. If parasites are seen, start counting number of white blood cells and parasites simultaneously up to a WBC of 200.
- x. If the parasitemia level is less than 10/200WBC, continue to count up 500 WBC
- xi. Report the number of parasites count per 200 or 500 white blood cells in the Blood parasites worksheet.
- xii. Retain the read slides for 3 Months

### **2.2.14 Biological Reference Intervals**

Not Applicable

### **2.2.15 Reporting and Interpretation of Results**

#### ***Malaria parasites***

Typical Malaria parasites have the following features on the Giemsa stained films;

Purple red chromatin dot, Blue cytoplasm, Brown-black/yellowish green pigment and

Distinct morphology

#### ***Interpretation***

In stained blood films, trophozoites appear as red stained chromatin dots with blue staining cytoplasm. If doubtful on parasites seen, search for definite ones. Do not make a diagnosis on the basis of structures that resemble rings or chromatin dots alone. Structures that may be confused with malaria parasites are platelets, portions or other red cell inclusion bodies

#### ***Reporting***

If no parasites are seen report as “No parasites seen”

If malaria parasites are seen, report species identified and count e.g. “*Plasmodium species* seen 50/200WBC”

### **Critical values**

The following are the Panic/Critical values for Malaria microscope test results. In case of the patient result falling inside the indicated values, call the Doctor or relevant ward and record the details of the conversation on the Panic Result Book

<b>Test</b>	<b>Critical value</b>
Malaria for Under 5 years	>100 <i>P.falciparum</i> Asexual/200wbc's
Malaria for > 5 years& adult	>1000 <i>P.falciparum</i> Asexual/200wbc's
None Tropical people	ANY POSITIVE

#### **2.2.16 Limitation of the Procedure and Sources of Errors**

Poor storage of reagents or using the reagents after expiry date may cause false results.

Difficulty in distinguishing young ring-stage parasites

#### **2.2.17 Performance characteristics**

Refer to the method verification report of this procedure.

#### **2.2.18 Supporting Documents**

Not Applicable

#### **2.2.19 References**

- Practical Laboratory Manual-Jane Carter and Orgenes Lema
- Standard Operating Procedure Essential Laboratory Tests {AMREF-2008 } EXT 120
- Basic Malaria Microscopy Part I. Learner's Guide, Second edition, WHO.

## **2.3. PROCEDURE FOR URINE MICROSCOPY**

### **2.3.1 Purpose**

The purpose of this procedure is to provide step by step instructions for performing macroscopic and microscopic examination of urine sediment samples

### **2.3.2 Scope**

This procedure is used during examination of urine samples in Parasitology section in medical laboratory.

### **2.3.3 Responsibility**

The Registered medical laboratory personnel is responsible for effective implementation and maintenance of this procedure.

### **2.3.4 Principle**

#### **Macroscopic Examination**

The urine is visualized with naked eyes to determine its appearance (turbidity and colour).

#### **Microscopic Examination**

The urine sediment is analyzed by a microscope to observe the presence of white blood cells, red blood cells, parasites and other abnormalities in urine sample. Identification of cells (WBC (pus cells), RBGs and Epithelial), casts, crystals, amorphous phosphates, bacteria and parasites in urine is based on their different cellular and intra-cellular morphology under light microscopy.

### **2.3.5 Sample Requirements**

20 mL, minimum 1 mL Fresh, cleanly voided urine collected in a clean container

Early morning voided mid-stream urine. Other samples include;

Random urine (collected at any time of the day)

Terminal urine sample collected at any time of the day for demonstrating ova of *Schistosoma haematobium*

First voided urine sample in the morning is used to demonstrate *Trichomonas vaginalis* in males

In infants and babies, a random urine sample collected as early as possible is used for all types of urine investigation.

### **2.3.6 Equipment**

Microscope, Centrifuge machine, Refrigerator, Timer, and Forceps

### **2.3.7 Materials**

Gloves, Cover slips, Glass slides, Test tubes, Centrifuge tubes, Gauze, Grease pencil, Lens paper, Waste containers, Urine container, Laboratory coat, Marker pen

### **2.3.8 Storage and stability**

Process urine sample within 1 hour of collection, if not possible refrigerate at 2-8°C immediately and test within 12 hours.

### **2.3.9 Safety**

- i. Adhere to safety precautions as stated in the Safety manual
- ii. All personal protective equipment (PPE) must be worn when performing this procedure.
- iii. All samples must be regarded as potentially infectious.
- iv. Refer to National infection prevention and control Guidelines for health waste management and safety practice.

### **2.3.10 Calibration**

Urine analyzers, , timer and centrifuge should be calibrated as per schedule

Maintenance of all equipments should be done as planned

### **2.3.11 Quality Control**

Quality control should be performed daily before processing patient samples by analysing known positive and negative samples.

### **2.3.12 Procedure**

#### ***Macroscopic examination***

Observe the appearance of the urine for color and clarity/turbidity

#### ***Microscopic examination***

- i. Label the centrifuge tubes with the laboratory unit number using a grease pencil and arrange into a rack.
- ii. If the urine sample is to be tested both for urinalysis and culture, mix well by inverting three times and aliquot the sample into a centrifuge tube and label exactly as the original sample
- iii. Transfer the centrifuge tubes containing urine sample into the centrifuge.
- iv. Make sure the centrifuge tubes are balanced well.
- v. Centrifuge the urines at 3000rpm for 5 minutes.
- vi. Remove the centrifuge tubes from the centrifuge

- vii. Pour off the supernatant into the sink with running water and leave the urine deposit
- viii. Transfer the rack containing arranged centrifuge test tubes to the working area
- ix. Arrange the marked slides according to the number of urine sample
  - x. Re-suspend the urine deposit by tapping the bottom of the centrifuge tube.
  - xi. Transfer a drop of the deposit onto a clean glass slide.
  - xii. Put on a cover slip
  - xiii. Place the slide on the microscope stage and reduce the iris diaphragm
  - xiv. Examine the slide systematically using x 10 objective and count the cells, casts, crystals, amorphous phosphates and parasites (these structures are more likely to be seen around the edges of the cover slip.
  - xv. Swing the x40 objective into position
  - xvi. Open the iris diaphragm very slightly to allow just enough light to provide a contrast of cells, casts, crystal and amorphous phosphates against the bright back ground (these structures are more likely to be seen around the edges of the cover slip).
  - xvii. structures cannot be seen if a very bright light is used
  - xviii. Put the used glass slide and cover slip in a container with disinfectant.

### ***2.3.13 Biological Reference interval***

#### **Macroscopy**

Color	Straw - Dark yellow
Appearance	Clear - Hazy

#### ***Microscopy***

Red blood cells:	0–2/hpf.
WBC (PUS CELL)/Pus cells:	0–5/hpf
Casts	0-4/hpf
Bacteria	Negative

### ***2.3.14 Interpretation and Reporting of Results***

#### **Macroscopic**

Report the Turbidity and color of the urine e.g. Clear yellowish, Blood stained etc.

#### **Microscopic**

Report a range of the actual highest number of WBC (pus cells), RBC and Parasites per high power field as counted under x40 objective (e.g. 0 – 2 RBC/HPF, 3 – 5 WBC/HPF, 10 – 12 S. haematobium ova/HPF) etc.

For crystals, Epithelial cells, yeasts or casts, report as +, ++ or +++. Where + indicates 1 to 9 observed findings per field; ++ indicates 10 to 100 observed findings per field; +++ indicates above 100 observed findings per field.

If no cells or parasites are seen report as “No parasites or cells seen.”

### **Results interpretation**

*Schistosomes Haematobium* ova in urine indicates Schistosomiasis disease

Presences of more than 3 Red blood cells for males, more than 8 red blood cells for females and any RBC or WBC (pus cell) for children and notification of more than 8 WBC (Pus Cell) in either male or female is pathological significant.

White blood cells may indicate infection or inflammation.

Red blood cells may indicate kidney disease, a blood disorder, or bladder cancer.

Bacteria can indicate infection.

Skin cells can indicate infection or kidney disease.

Crystals may be a sign of kidney stones.

Casts, or tube-shaped proteins, may be a sign of a kidney disorder.

Parasites can indicate parasitic disease in various parts of the body.

### **2.3.15 Limitations of the Procedure and Sources of Errors**

Inadequate centrifugation of sample

Poor collection of urine sample

Prolonged storage of urine sample at wrong temperature

Expired reagents

Technical competency level

Presence of artifacts such as plant cells

### **2.3.16 Performance Characteristics**

Not Applicable

### **2.3.17 Supporting document**

Sample Collection Manual

### **2.3.18 References**

- Monica Cheesbrough: District Laboratory Practice in Tropical Countries, Vol 1, Tropical Health Technology, 1998.
- Practical Laboratory Manual-Jane Carter and Orgenes Lema



## **2.4. PROCEDURE FOR STOOL ROUTINE EXAMINATION**

### **2.4.1 Purpose**

This procedure provides instructions for examination of stool macroscopic and microscopic to detect abnormalities/Parasites. The most common parasites include the roundworms *Ascaris lumbricoides* and *Necator americanus* (commonly called hookworm); the tapeworms *D. latum*, *Taenia saginata*, and, rarely, *T. solium*; the amoeba *E. histolytica*; and the flagellate *G. lamblia*.

### **2.4.2 Scope**

This procedure is used during examination of stool in Parasitology Section.

### **2.4.3 Responsibility**

The Registered medical laboratory personnel are responsible for implementing this test procedure.

The Head of Parasitology section is responsible for ensuring the effective implementation and maintenance of this procedure

### **2.4.4 Principle**

Normal saline retains the morphology of the organism in its natural shape and color, free helminthes eggs from debris.

Iodine - stains the internal structure of cyst to brown/yellow color so to allow the study of cyst morphology. It also kills the organisms to allow internal structure easily seen.

### **2.4.5 Sample Requirements**

Stool collected in Clean plastic screw capped container which has spoon like. Include macroscopic worms or worm segments as well as bloody and mucoid portions of the sample.

About 150mg stool should be collected.

### **2.4.6 Equipment**

Microscope, Tally counters or differential counter, Centrifuge and Fume hood

#### **Maintenance**

Maintenance of microscopes should be done as planned

### **2.4.7 Materials**

Normal saline, 1% Iodine, 10% formalin, Wooden applicator stick, Grease pencil, Gloves, Microscopic slides, Cover slip, Marker and Stool container

### **2.4.8 Storage and stability**

Stool sample should be at the laboratory within two hours after collection. If a liquid or soft stool sample can't be examined within 30 minutes of passage, place it in a preservative; if a formed stool sample can't be examined immediately, refrigerate it or place it in preservative.

### **2.4.9 Safety**

- All samples must be considered as potentially infectious and must be handled and examined with care.
- All personal protective equipments (PPE) should be worn when performing procedure
- Adhere to safety precautions as stated in the Safety manual
- Refer to National infection prevention and control Guidelines for health waste management and safety practice.

### **2.4.10 Calibration**

Calibration of centrifuge should be done as per schedule

### **2.4.11 Quality Control**

Quality control should be performed daily before processing patient samples by using known positive and negative samples

### **2.4.12 Procedure**

#### **Macroscopic Observations**

Observe the stool sample for the following; Color of the samples, Consistency, Presence of blood, mucus, and, or, pus. Whether the samples contain worms.

#### **Wet Preparation by Saline and 1% Iodine**

- i. Using marker label a microscope slide with the laboratory number
- ii. Place a drop of fresh physiological saline at one end of a slide and a drop of 1% Iodine on the other end.
- iii. Using applicator stick, pick up a size of match head stool (~2 mg) and mix with a drop of saline and a similar amount with Iodine to make a smooth thin preparation.
- iv. If stool is formed, the portion should include the inside and outside parts of the sample
- v. For mucoid or watery stool, mix the entire contents before picking a portion to mix with saline.
- vi. Cover the preparations with a cover slip.
- vii. Start with 10x objective to systematically, examine the entire saline preparation.
- viii. Use the 40x objective to assist in the detection and identification of parasitic elements (eggs, ova, cyst etc). Always examine several

microscope fields with this objective before reporting 'No parasites seen.'

- ix. Use the iodine preparation to assist in the identification of cysts.
- x. Report the findings on Stool analysis worksheet.
- xi. Discard the used microscope slide on the container with disinfectant.

#### **2.4.13 Biological Reference Intervals**

Not Applicable

#### **2.4.14 Interpretation and Reporting of Results**

##### **Interpretation**

- i. Adult helminths or portions of helminths may be recovered and seen with a naked eye. Examples include *E. vermicularis* adult worms, *Ascaris lumbricoides* adult worms, and tapeworm proglottids.
- ii. Occasionally, other helminths may be recovered (hookworm, *Strongyloides stercoralis*), but identification requires the use of the microscope.
- iii. The appearance of stool will yield different interpretation such as; blood and mucus in faeces: might be suggestive of amoebic dysentery, intestinal schistosomiasis, invasive balantidiasis (rare infection), and severe *T. trichiura* infections. Other non-parasitic conditions in which blood and mucus may be found include bacillary dysentery, *Campylobacter* enteritis, ulcerative colitis, intestinal tumour, and haemorrhoids.
- iv. **Presence of pus:** This can be found when there is inflammation of the intestinal tract. Many pus cells can be found in faecal samples from patients with bacillary dysentery. They can also be found in amoebic dysentery but are less numerous.
- v. **Pale coloured and frothy (containing fat) samples:** might be suggestive of giardiasis and other infections associated with intestinal malabsorption.
- vi. **Pale coloured faeces:** (lacking stercobilinogen) might be suggestive of an obstructive jaundice.
- vii. Mucoïd and blood diarrhea might be suggestive to presence of *E. histolytica*

##### **Reporting**

###### **Macroscopic Findings - Report the following:**

- i. Colour of the samples.
- ii. Consistency, i.e. whether formed, semiformed, unformed, watery.
- iii. Presence of blood, mucus, and, or, pus. If blood is present note whether this is mixed in the faeces. If only on the surface this indicates rectal or anal bleeding.

- iv. Presence of worms, e.g. *A. lumbricoides* (large roundworm), *E. vermicularis* (threadworm) or tapeworm segments, e.g. *T. solium*, *T. saginata*.

#### **Microscopic Findings – Report the Following**

- i. Report presence of any ova, trophozoites or cysts seen, specifying the species, e.g. “Entamoeba histolytica trophozoites seen”.
- ii. If no parasites are seen report as “ No ova or cysts seen”.

#### **2.4.15 Limitation of the Procedure and Sources of Error**

Delay in examination of stool sample may cause missing of some parasites in wet preparation which are detected still alive. Examples of such organisms are *Strongyloides stercoralis*, *Giardia lamblia* *E. Histolytica* trophozoites, etc.

Presence of urine kills trophozoites (false-negative results).

Excessive heat or cold.

#### **2.4.16 Performance Characteristics**

Refer to the method verification of this procedure.

#### **2.4.17 Supporting Documents**

Not Applicable

#### **2.4.18 References**

- Practical Laboratory Manual-Jane Carter and Orgenes Lema
- Monica Cheesbrough: District Laboratory Practice in Tropical Countries, Vol 1,
- Tropical Health Technology, 1998.
- Brunner & Suddarth’s Handbook of Laboratory and Diagnostic Tests, 2010.

## **2.5. PROCEDURE FOR EXAMINATION OF BLOOD FOR MICROFILARIAE**

### **2.5.1 Purpose**

This procedure provides instructions for processing of blood, lymphatic, and cerebrospinal fluid for the recovery of lymphatic filariasis. Diagnosis of filarial infections is often confirmed by demonstration of the parasite.

### **2.5.2 Scope**

This procedure is used during examination procedures to diagnose filarial infections in the Laboratory using Microscopy.

### **2.5.3 Responsibility**

Qualified and trained Medical Laboratory Technician is responsible for performing this test procedure. The Head of Parasitology unit is responsible for ensuring the effective implementation and maintenance of this procedure.

### **2.5.4 Principle**

#### **Giemsa stain**

Giemsa stain is a Romanowsky stain contains methylene blue which is basic stain and eosin is acidic stain, the parasites has DNA in the nucleus which is basic in nature and RNA in the cytoplasm is acidic in nature, during staining the reactions takes place whereby acidic part of a parasite will pick-up basic part of the stain and the basic part of the parasite will pick-up the acid part of the stain, that's why the nucleus of the parasite will show red color and the cytoplasm will stain bluish.

#### **Wet preparation**

Microfilariae are seen in wet preparations of blood on direct microscopic examination or in the deposit of a blood sample after lysis with formalin and centrifugation.

### **2.5.5 5.0. Sample Requirements**

Whole blood collected in EDTA tube should be collected around midnight (22:00 – 04:00 for *W. Bancrofti* and 10:00 – 15:00 for *L. Loa*), as this is the time when parasite is present in the blood for microfilaria worms.

### **2.5.6 Equipment**

Hot plate, Tally counters or differential counter, Microscope, Centrifuge, Timer, Weighing scale and PH Meter

### **2.5.7 Materials**

10 % Giemsa stain working solution, 70% Methylated spirit, Distilled water, Immersion oil, Tap water, buffer solution, Cover slips, Glass slide, Rack, Slide drying rack,

### **2.5.8 Storage and Stability**

The Giemsa stock stain should be stored in a dark bottle and take precautions to avoid moisture entering the stain.

### **2.5.9 Safety**

- All samples must be considered as potentially infectious and must be handled and examined with care.
- All personal protective equipments (PPE) should be worn when performing procedure
- Adhere to safety precautions as stated in the Safety manual
- Refer to National infection prevention and control Guidelines for health waste management and safety practice.

### **2.5.10 Calibration**

Calibration of centrifuge, PH meter and weighing scale should be performed as planned. maintenance of microscopes should be done as planned

### **2.5.11 Quality Control**

Positive and negative control samples are processed once a day in the morning before patient samples.

### **2.5.12 Procedure Steps**

#### **Step 1: Procedural Steps - Wet Preparation**

- i. Collect 10 ml of venous blood and dispense it into 10 ml of water.
- ii. Mix the blood gently in water and leave for 10 minutes to give time for all the red cells to lyse.
- iii. Centrifuge the haemolyzed sample for 10 minutes at slow to medium speed, i.e. RCF 300–500 g.
- iv. Using a Pasteur pipette, immediately remove and discard the supernatant fluid.
- v. Transfer the sediment to a slide, add a small drop of methylene blue and cover with a cover glass. The stain will be taken up by the nuclei and show whether the microfilariae are sheathed.
- vi. Examine the entire preparation microscopically for motile microfilariae using the 10× objective with the condenser iris closed sufficiently to give good contrast.
- vii. Count the number of microfilariae in the entire preparation. Divide the number counted by 10 to give the approximate number of microfilariae per ml of blood (mf/ml).
- viii. If unable to identify the species with certainty, continue with step 2 (examination with 10% Giemsa stain under oil immersion objective).

#### **Step 2: Procedural Steps – 10 % Giemsa Staining Procedure**

- i. Remove the cover glass and add a small drop of plasma, serum, or albumin solution.
- ii. Mix and spread thinly. Allow the preparation to dry completely.
- iii. The addition of albumin, plasma, or serum (known to be microfilaria-free) will help to prevent the preparation from being washed from the slide during staining.
- iv. Fix with absolute methanol or ethanol for 2–3 minutes.
- v. Flood the films with 10% Giemsa solution and leave to stain for 15 minutes.
- vi. Decant the Giemsa and wash in buffered water at pH 7.2 or distilled water
- vii. Clean the back of each slide with cotton wool or gauze
- viii. Place a drop of immersion on the thick film and place the slide on the microscope stage
- ix. Swing the x10 objective into position and bring the film into focus.
- x. Swing the x100 oil immersion objective into position and focus.
- xi. Examine the thick film systematically starting from the top left hand corner and move from field to field.

### **2.5.13 Biological Reference Intervals**

Not Applicable

### **2.5.14 Reporting and Interpretation of Results**

#### **Microfilaria**

Species are identified by noting the arrangement of the nuclei towards the end of the tail and the presence of sheath. *W. bancrofti* and *Loa loa* have a sheath; *M. perstans* does not have a sheath. In *Loa loa* and *M. perstans*, the nuclei reach the tail tip and the tail tip is rounded. In *W. bancrofti*, the tail tip is pointed.

#### **Trypanosomes**

Trypanosomes have elongated, flat, narrow bodies, often curved. In wet preparations, they move rapidly by means of an undulating membrane and flagellum. In stained preparations, the kinetoplast, a dark staining round body from which the flagellum originates, is seen.

### **2.5.15 Limitation of the Procedure and Sources of Errors**

- Incorrectly timed samples for microfilaria or trypanosomes
- Poor storage of reagents or using the reagents after expiry date

### **2.5.16 Performance Characteristics**

Refer to the method verification report of this procedure.

### **2.5.17 Supporting Documents**

Sample collection manual

### **2.5.18 References**

- Practical Laboratory Manual-Jane Carter and Orgenes Lema
- Standard Operating Procedure Essential Laboratory Tests {AMREF-2008}  
EXT 120



## **2.6. PROCEDURE FOR EXAMINATION OF SKIN FOR MICROFILARIAE**

### **2.6.1 Purpose**

This procedure provides instructions for examination of Skin snips to diagnose onchocerciasis caused by a filarial worm known as *Onchocerca volvulus*. The disease is also known as river blindness because invasion of the eye can lead to loss of vision.

### **2.6.2 Scope**

This procedure applies to health laboratory practitioners in the laboratory settings.

### **2.6.3 Responsibility**

Section heads are responsible for ensuring that only qualified and competent health laboratory practitioners carry out this procedure.

### **2.6.4 Principle**

Giemsa stain is a Romanowsky stain contains methylene blue which is basic stain and eosin is acidic stain, the parasites has DNA in the nucleus which is basic in nature and RNA in the cytoplasm is acidic in nature, during staining the reactions takes place whereby acidic part of a parasite will pick-up basic part of the stain and the basic part of the parasite will pick-up the acid part of the stain, that's why the nucleus of the parasite will show red color and the cytoplasm will stain bluish.

### **2.6.5 Sample Requirements**

**Skin snips** collected using a sterile needle and razor blade (or scalpel) should be taken from those sites such as in the buttocks, iliac crests or calves of the legs.

*Important:* A bloodless skin snip is required.

### **2.6.6 Equipment**

Microscope, PH meter, Forceps

### **2.6.7 Materials**

10 % Giemsa stain working solution, Cover slips, Glass slide, Centrifuge tubes, Grease pencil, Filter paper, Marker pen or ball point pen, Alcohol swab, Gloves, Pasteur pipette, Filter paper or paper towel and EDTA tubes

### **2.6.8 Storage and stability**

The Giemsa stock stain should be stored in a dark bottle and take precautions to avoid moisture entering the stain.

### **2.6.9 Safety**

- i. All samples must be considered as potentially infectious and must be handled and examined with care.
- ii. All personal protective equipments (PPE) should be worn when performing procedure
- iii. Adhere to safety precautions as stated in the Safety manual
- iv. Refer to National infection prevention and control Guidelines for health waste management and safety practice.

#### **2.6.10 Calibration**

Calibration of auxiliary equipment should be done as per schedule and that all calibration records including certificates should be available.

#### **2.6.11 Quality Control**

Positive and negative control samples are processed once a day in the morning before patient samples.

#### **2.6.12 Procedural steps**

- i. Immerse the skin snip in a conical centrifuge tube containing about 1 ml of fresh physiological saline and leave it at room temperature for up to 4 hours.
- ii. Using forceps, remove the skin snip, place it on a slide, and cover with a cover glass.
- iii. Centrifuge the contents of the tube at medium to high speed, i.e. RCF 500–1000, for 5 minutes. Remove and discard the supernatant fluid. Transfer the entire sediment to a slide.
- iv. Examine both the skin snip and sediment microscopically for microfilariae using the 10x objective with the condenser iris *closed sufficiently* to give good contrast.

If no microfilariae are seen, immerse the skin snip in a further 1 ml of saline and reincubate.

If after overnight incubation no microfilariae are seen, report the preparation as 'Negative'.

If microfilariae are present, proceed to step v below:

- v. Remove the cover glass and allow the preparation to dry completely.
- vi. Fix the dried preparation with absolute methanol or ethanol for 2–3 minutes.
- vii. Stain and Examine the preparation as explained under Giemsa staining procedure.

#### **2.6.13 Biological Reference Intervals**

Not Applicable

#### **2.6.14 Interpretation and Reporting of Results**

Report the number of microfilariae as scanty, few, moderate numbers, or many. If after overnight incubation no microfilariae are seen, report the preparation as 'Negative'.

#### **2.6.15 Limitation of the Procedure and Sources of Error**

Poor storage of reagents or using the reagents after expiry date may cause false results.

#### **2.6.16 Performance Characteristics**

Refer to the method verification of this procedure

#### **2.6.17 Supporting Documents**

Not Applicable

#### **2.6.18 References**

- Practical Laboratory Manual-Jane Carter and Orgenes Lema
- Standard Operating Procedure Essential Laboratory Tests {AMREF-2008 }  
EXT 120

## 2.7. PROCEDURE FOR PERFORMING OCCULT BLOOD

### 2.7.1 Purpose

This procedure provides instructions for performing occult blood test using Hema-Screen slide.

### 2.7.2 Scope

This procedure applies to the Parasitological department for detection of faecal occult blood.

### 2.7.3 Responsibility

Qualified and competent health laboratory practitioners carry out this procedure.

### 2.7.4 Principle

Hema-screen is composed of guaiac impregnated paper enclosed in a cardboard frame which permits sample application to one side, and interpretation on the reverse side. The process involves placing two samples, collected from three successive evacuations, onto guaiac paper.

Haema-screen is based on the oxidation of phenolic compounds present in the guaiaconic acid to quinones results in the production of blue colour. Because of its similarity to the prosthetic group of peroxidase, the heme part of the haemoglobin molecule can function in a pseudoenzymatic manner, catalysing the oxidation of guaiac.

When fecal sample containing occult blood is applied to the test paper, contact is made between hemoglobin and guaiac. A pseudoperoxidase reaction will occur upon addition of the developer solution, with a blue chromagen formed proportionally to the concentration of haemoglobins.

The colour reaction will occur after thirty seconds.

Haemoglobin + Developer

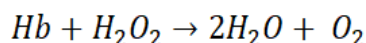

Oxidation of Guaiac

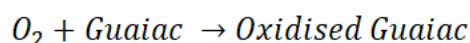

(colourless)

(blue)

The hema- screen kits include on-slide monitors which provide a quality control system for each test.

### **2.7.5 Sample Requirements**

Fresh stool sample collected by patient from toilet bowl

### **2.7.6 Equipment**

Microscope

### **2.7.7 Materials**

Hema-screen slide with control, Hema-screen developer, Sample applicator

### **2.7.8 Storage And Stability**

The slide should be stored at room temperature (15-30°C), do not use after expiration date. The slide should be protected from heat, humidity, fluorescent light, U.V. radiation, excessive air flow or volatile chemicals (e.g. iodine or bleach). Do not refrigerate or freeze.

### **2.7.9 Safety**

Universal safety precautions should be taken into considerations and that all biological substances and reagents should be treated as potentially infectious.

### **2.7.10 Calibration**

Not Applicable

### **2.7.11 Quality Control**

Quality controls are provided on each hema-screen slide. This specially treated area provides assurance that the guaiac-impregnated paper and developer are reacting according to product specification.

### **2.7.12 Procedure Steps**

#### **Procedure for stool occult blood test**

- i. Fill the information on the front flap of the Hema-Screen slide.
- ii. Open the front flap.
- iii. Using the applicator sticks provided, collect a small amount of stool from the container on one end of the applicator sticks. Apply very thin smear in box 1.
- iv. Reuse applicator to obtain a second sample from a different part of the stool sample. Apply a very thin smear inside box 2 discard the stick and stool container in highly infectious waste container.
- v. Allow sample to air dry, and then close the cover.
- vi. Open perforated window on the back of the slide
- vii. Apply 2 drops of developer to the back side of boxes 1 and 2
- viii. Read results after 30 seconds and within 2 minutes.

- ix. Record results; any trace of blue, within or on the outer rim of the sample, is positive for occult blood.
- x. Place one or two drops of developer between the positive and negative IQC boxes.
- xi. Read the results after 30 seconds and within 2 minutes.
- xii. The positive control should turn to blue but the negative control should not have any trace of blue.

#### **2.7.13 Biological Reference Intervals**

Not Applicable

#### **2.7.14 Interpretation And Reporting Of Results**

Report **positive** for any blue trace in the sample area

Report **negative** if there is no any blue trace in the sample area

#### **2.7.15 Limitations of the procedure and Sources of error**

- i. Medication such as aspirin and other inflammatory drugs.
- ii. Rectal medicines, tonics or vitamin C preparation which contain vitamin C (ascorbic acid) in excess of 250mg per day.
- iii. Bleeding haemorrhoids or open cuts on hands.
- iv. Menstruation
- v. Improper sample collection
- vi. Other disease of gastrointestinal track
- vii. Poor storage of reagents or using the reagents after expiry date may cause false results.

#### **2.7.16 Performance Characteristics**

Refer to the method verification of this procedure

#### **2.7.17 Supporting Documents**

Sample collection manual

#### **2.7.18 References**

- Package insert
- Concise Book of Medical Laboratory Technology Methods and Interpretations.

## 2.8. PROCEDURE FOR STOOL ANALYSIS BY FORMAL ETHER CONCENTRATION TECHNIQUE

### 2.8.1 Purpose

This procedure provides instructions for examination of stool by modified Formal – Ether sedimentation technique. The procedure is recommended when low number of parasites or intestinal schistosomiasis is suspected and no eggs are found by direct examination. It is also used to confirm whether treatment of the parasites has been successful.

### 2.8.2 Scope

This procedure is used in parasitology section for identification of protozoan and parasitic eggs, larvae, and oocysts.

### 2.8.3 Responsibility

Qualified and trained Medical Laboratory Technicians, Technologists and scientists are responsible for implementing this test procedure.

The Head of Unit Microbiology is responsible for ensuring the effective implementation and maintenance of this procedure.

### 2.8.4 Principle

Sedimentation technique uses solution of lower specific gravity than parasitic organisms, thus concentrating the latter in the sediment. The formal-ether solution has relatively lower specific gravity than protozoan cysts and helminth eggs thus they settle down the solution. Their natural tendency to settle out in aqueous solutions can be accelerated by light centrifugation. Formalin fixes the eggs, larvae, oocysts, and spores, so that they are no longer infectious, as well as preserves their morphology. Fecal debris is extracted into the ethyl acetate phase of the solution.

### 2.8.5 Sample Requirements

Stool collected in Clean plastic screw capped container which has spoon like. Include macroscopic worms or worm segments as well as bloody and mucoid portions of the sample. About 150mg stool should be collected.

### 2.8.6 Equipment

Microscope, Vortex, Centrifuge and fume chamber

### 2.8.7 Materials

Reagent	Consumables
<ul style="list-style-type: none"><li>• Normal saline</li><li>• 1% Iodine</li><li>• 10% formalin</li><li>• Ether</li><li>• Developing solution</li><li>• Buffered methylene blue</li></ul>	<ul style="list-style-type: none"><li>• Wooden applicator stick</li><li>• Grease pencil</li><li>• Gloves</li><li>• Microscopic slides</li><li>• Cover slip</li><li>• Marker</li><li>• Goggles</li><li>• Gauze</li></ul>

<ul style="list-style-type: none"> <li>• 3% Malachite green or methylene blue solution</li> <li>• Glycerol</li> <li>• Distilled water</li> <li>• Carbol-fuchsin</li> <li>• Formaldehyde</li> <li>• Hydrochloric acid-ethanol solution</li> <li>• Glycerol-malachite green or methylene blue</li> <li>• Hydrochloric acid-methanol solution</li> <li>• Running tape water</li> <li>• Modified ZIEHL-Neelsen stain or Safranin Methylene stain.</li> </ul>	<ul style="list-style-type: none"> <li>• Centrifuge tubes</li> <li>• Pestle and mortar</li> <li>• Glass slides</li> <li>• Pipettes</li> <li>• Measuring cylinder</li> <li>• Funnel</li> <li>• Rack</li> <li>• Cellophane tape</li> <li>• Forceps</li> <li>• Toilet paper or absorbent tissue</li> <li>• News paper</li> <li>• Flat-bottomed jar</li> <li>• Cellophane tape (40-50 micrometer)</li> <li>• Staining dishes</li> <li>• Rubber cork</li> <li>• Rod, glass</li> <li>• Slide holder, for finished slides</li> <li>• Small bottle of mounting medium</li> <li>• Paper towel or sponge</li> </ul>
--	---

### **2.8.8 Storage And Stability**

Stool sample should be at the laboratory within two hours after collection. If a liquid or soft stool sample can't be examined within 30 minutes of passage, place it in a preservative; if a formed stool sample can't be examined immediately, refrigerate it or place it in preservative.

### **2.8.9 Safety**

- a) Use gloves when performing the procedure and handling the sample, disposing of equipment, sealing the container, and transporting the sample. Dispose of gloves after sample collection and transport.
- b) Adhere to safety precautions as stated in the Safety manual.
- c) All samples must be regarded as potentially infections.
- d) Refer to National infection prevention and control Guidelines for health waste management and safety practice.
- e) Ether is flammable and that Formalin is an irritant.

### **2.8.10 Calibration**

All auxiliary equipment should be calibrated annually

### **2.8.11 Quality Control**

- Check solutions whether are free from contamination or not.
- Run known positive sample as positive control through the procedure to verify organism recovery. This should be done following laboratory established procedure



### **2.8.12 Procedure Steps**

- i. First, wear gloves when handling stool samples.
- ii. In a suitable container, thoroughly mix a portion of stool sample approximately 1 ml or 1gm into 10 ml of normal saline. Mix thoroughly with the help of a vortex.
- iii. Filter the emulsion through fine mesh gauze or alternatively wire sieve into a conical centrifuge tube
- iv. Centrifuge the suspension at 2000 rpm for 10 minutes. Note: The suspension should yield about 0.75 ml of sediment for fresh samples and 0.5 ml for formalized feces.
- v. Discard the supernatant and wash the sediment with 10 ml of saline solution. Centrifuge again and repeat washing until the supernatant is clear.
- vi. After the last wash, discard the supernatant and add 10 ml of 10% formalin to the sediment. Mix and let stand for 5 minutes to effect fixation.
- vii. Add 1 to 2 ml of ethyl acetate, Stopper the tube, and shake vigorously.
- viii. Centrifuge at 1500 rpm for 10 minutes. Four layers should result as a top layer of ethyl acetate, plug of debris, layer of formalin, and sediment respectively.
- ix. Free the plug of debris from the side of the tube by removing with an applicator stick. Carefully discard the top three layers.
- x. Mix the remaining sediment with a pipette
- xi. Transfer one drop each to a drop of saline and iodine on a glass slide and mix.
- xii. Cover with a coverslip and observe systematically first for the presence of parasitic forms, eggs, larvae, and oocysts under low power (10X) objective, and then high power (40X) objective under the microscope.
- xiii. Report the findings on Stool analysis worksheet
- xiv. Discard the used glass slide and cover slip on the sharps bucket container with disinfectant

### **2.8.13 Biological Reference Intervals**

Not applicable

### **2.8.14 Interpretation and Reporting of Results**

Presence of parasite or parasitic elements indicate parasitic infections

### **2.8.15 Reporting of results**

Report the presence of any ova, trophozoites, larvae or oocysts seen, specifying the species, e.g. "Entamoeba histolytica trophozoites or oocyst seen

If no parasites or ova, oocyst or larvae are seen report as No ova, oocysts or larvae seen.

### **2.8.16 Limitations of the procedure and sources of error**

- i. Requires several pieces of apparatus which does not make it an easy.
- ii. Hymenolepis nana and Fasciola spp. do not concentrate well

- iii. Presence of urine kills trophozoites (false-negative results).
- iv. Excessive heat or cold.
- v. Recent barium studies (possible interference with detection of organism).

### **2.8.17 Performance Characteristics**

Refer to the laboratory method verification procedure

### **2.8.18 Supporting Documents**

- Laboratory quality policy manual
- Laboratory safety policy manual
- Laboratory sample collection manual

### **2.8.19 References**

- i. Merrell and Vogt's medical parasitology 9th edition.
- ii. Parasitology: 12th edition By K. D. Chatterjee
- iii. District laboratory practice in Tropical countries –Part-I. By Monica Cheesbrough.
- iv. Isenberg clinical microbiology procedures Handbook 2nd edition. Vol. 2
- v. Atlas of Medical Helminthology and protozoology -4th edn -P.L. Chiodini, A.H. Moody, D.W. Manser
- vi. Medical Parasitology by Abhay R. Satoskar, Gary L. Simon, Peter J. Hotez and Moriya Tsuji
- vii. Practical Laboratory Manual-Jane Carter and Orgenes Lema

## CHAPTER 3: BLOOD TRANSFUSION

---

### 3. PROCEDURE FOR ABO AND RHESUS BLOOD GROUPING

#### 3.1. Purpose

This procedure provides instructions for performing ABO and Rhesus (D) blood grouping using tube method.

#### 3.2. Scope

This procedure is used in Blood Transfusion unit when performing ABO & Rhesus(D) blood group typing for donors and patients.

#### 3.3. Responsibility

The head of Blood Transfusion and competent medical laboratory personnel are responsible for ensuring this procedure is effectively implemented and maintained.

#### 3.4. Principle

This method is based on immunophenotyping principle. The known antibodies A&B(antisera) react with unknown antigens on the red cells surface to form agglutination or haemolysis; this is known as **forward or cells grouping**. Also known antigens (A and B) react with unknown antibodies in the patient or donor serum/plasma to form agglutination or haemolysis; this is known as **backward or serum blood grouping**.

The D antigen on the red cells surface reacts which known D antibodies(anti-D) to form agglutination which determines the Rhesus group of an individual, either as Rh (D) **Positive**(agglutination) or Rh (D) **Negative** (no agglutination).

#### 3.5. Sample Requirements

2-3mls of EDTA sample, 2-3mls of clotted sample from plain tube  
Centrifuge the sample at 3500rpm (RCF) for 5 minutes.

#### 3.6. Equipment

Centrifuge, Microscope, Refrigerator, Timers, 37°C water bath and Thermometer

#### 3.7. Materials

Reagent	Consumables
Anti –A	Gloves
Anti-B	Laboratory coat
Anti-D (saline, IgM)	Test tubes,

Incomplete anti-D (IgG) Anti-Human Globulin Serum (AGS) 0.85% Physiological Saline Low ionic strength solution (LISS)	Test tube rack, slides Marker pens, Beakers, Pasteur pipettes,
--	--

### 3.8. Storage and Stability

- Store serum or plasma at 2°C -8°C for 7 days.
- Whole blood is stored at 2°C - 8°C for 3 days
- Anti-sera should be kept at 2°C – 8°C or as per manufacturer instructions

### 3.9. Safety

- i. Adhere to safety precautions as stated in the Safety manual/ IPC guideline
- ii. All personnel protective equipment (PPE) must be worn when performing this procedure.
- iii. All samples must be regarded as potentially infections.

### 3.10. Calibration

Calibration of auxiliary equipment should be done as per calibration schedule

### 3.11. Quality Controls

Perform Quality Controls once in a week, when new antisera received and when new control cells are prepared.

#### 3.11.1. Controlling of anti-sera

- Commercial anti-sera are quality controlled by reacting them with known cell Suspension of A, B, O, Rh (D) Positive and Rh (D) Negative.
- Arrange 6 tubes labelled A, B, AB, O and D positive and D negative.
- Put one drop of 2-5% cell suspension of A, B, AB, O Rh (D) Positive and O Rh (D) Negative to the corresponding tubes above
- Add one drop Anti-A, Anti-B, Anti-AB and Anti-D into corresponding tubes.

#### 3.11.2. Controlling of O sensitized cells

- Label two tubes as O sensitized cells and O un sensitised cells
- Put one drop of corresponding of 3-5% cell suspension in the two tubes above.
- In the two tubes, add one drop of AHG each.

### 3.11.3. Controlling of physiological saline

- Label two tubes as saline and distilled water
- Put one drop of saline and one drop of distilled water to the respective tubes above
- Add one drop of O Rh (D) Positive cells to the two tubes

### 3.11.4. Common step

- Centrifuge all tubes above at light speed (1000rpm for 1 minute).
- Agglutination or haemolysis indicates positive reactions.
- Expected reactions are shown in table below
- Record results on ABO & Rh blood.

### 3.11.5. Interpretation of IQC results

Commer cial Antisera	Cell suspensions						
	A cells	B cells	AB cells	RhD pos cells	RhD Neg Cells	O- sensitised cells	Un- sensitise d cells
Anti A	+	-	+	-			
Anti B	-	+	+	-			
Anti AB	+	+	+	-			
Anti D					+		
LISS						+++	
AHG						+	-
Saline						+ to ++	
Distilled water						Haemolysis	

**Key:**

- + Agglutination
- No agglutination

*Note: Strength of agglutination is graded from 1+ (separate agglutination) to 3+ (one solid agglutination)*

### 3.12. Procedure Steps

#### *Prepare of 2- 5% cell suspension*

- Place 2-3 drops of donor red blood cells into a tube
- Fill the tube (3/4) with 0.85% normal saline
- Centrifuge the tube at 3400rpm for 2 to 3 minutes. Decant supernatant fluid. (Repeat 3 times)

- Transfer a drop of packed red cells from the above tubes and add 19 drops of saline to make 2% to 5% donor red cell suspension

### **3.12.1. Blood grouping procedure**

#### ***Forward/Cell Grouping***

- For each patient/donor label 3 test tubes as Anti-A tube (A), Anti-B tube (**B**), and anti-D tube (D).
- Arrange the labelled test tubes in the test tube rack
- Add one volume of anti A into tube A
- Add one volume of anti-B into tube B
- Add one volume of anti-D into tube D
- To each of the above tubes add one drop of 2 - 5% cell suspension and mix well.
- Centrifuge the three tubes at 1000rpm for one minute
- Examine the contents of the tubes for the evidence of agglutination.
- Read, interpret, and record the test results.

#### ***Backward/Serum Grouping***

- For each patient/donor, label 2 test tubes as A cells and B cells.
- Add two drops of serum to each tube.
- Add one drop of A reagent cells into tube labelled A cells,
- Add one drop of B reagent cells into tube labelled B cells
- Mix the contents of the tubes gently
- Centrifuge the tubes at 1000 rpm for one minute.
- Examine the serum for evidence of haemolysis, gently suspend the cell bottoms and examine them for agglutination macroscopically and microscopically.
- Read, interpret and record test results.

#### ***Procedure for Weak Rh (D)***

- If the above anti-D reaction is negative, confirm weak Rh (D) as follows:
- Add two drops of LISS
- Incubate at 37°C for 15 minutes in water bath. In absence of low ionic strength solution (LISS) incubate at room temperature for 30 minutes
- Spin for 1000rpm for 1 minute
- Observe for agglutination macroscopically and microscopically or for haemolysis
- If agglutination or haemolysis is observed at this stage, report result as Rh (D) Positive and the procedure ends here.
- If there is still no agglutination, proceed as follows:
- Wash contents of the tube 3 times with physiological saline
- Discard supernatant after third wash
- Add one drop Anti-Human Globulin Serum (AGS)
- Spin for 1000rpm for one minute

- xii. Observe for agglutination (macroscopically and microscopically) or haemolysis
- xiii. If agglutination is observed at this stage, report results as Rh (Du) Positive
- xiv. If reaction is still negative, add one drop of O sensitised cells to the tube
- xv. Spin for 1000rpm for 1minute
- xvi. Observe for agglutination (macroscopically and microscopically) or haemolysis
- xvii. Presence of agglutination or haemolysis indicates a valid negative result.
- xviii. Absence of agglutination or haemolysis means the test is invalid; therefore, it has to be repeated.

**Note:** For purposes of transfusion, patients with Rh(Du) Positive should be given rhesus negative blood.

### 3.13. Biological Reference Intervals

Not Applicable

### 3.14. Interpretation and Reporting of Results

Patient/Donor Cell Grouping					Patient/ Grouping	Donor	Serum
Anti-A	Anti-B	Ant-AB	Anti-D	Blood group &Rhesus factor	A-cells	B- cells	Blood group
+	-	+	+	A Rh(D)Pos	-	+	A
-	+	+	+	B Rh(D)Pos	+	-	B
+	+	+	+	AB Rh(D)Pos	-	-	AB
-	-	-	+	O Rh(D)Pos	+	+	O

**KEY:** - + Means Agglutination  
 - Means No Agglutination

#### *Reporting of results*

Results report should include the ABO Type and Rhesus D reaction results, e.g. Blood group A Rh (D) Positive, or Blood Group A Rh(D) Negative

### 3.15. Limitations of the Procedure and Source of Error

- Avoid haemolysed samples as this may lead to false negative results.
- Patients who have had recent multiple transfusions may develop allo-antibodies that can interfere with antigen – antibody reactions

### 3.16. Performance Characteristics

Refer to the method verification report

### **3.17. Supporting Documents**

Sample collection manual, safety manual, and quality manual.

### **3.18. References**

- i. Technical manual of the American Association of Blood Banks
- ii. Mollison P.L., Blood Transfusion in Clinical Medicine 8th Ed. Oxford. Blackwell Scientific, Practical haematology by Decie
- iii. Guidance manual on “ABO and Rh blood grouping” (Institute of Biologicals-India)
- iv. Anti-sera insert kit (Anti-A, Anti- B, Anti-AB, Anti- D Monoclonal blood grouping antibodies for tube and slide test) T Tulip diagnostics (P) LTD.



### **3.19. PROCEDURE FOR ESTIMATION OF HEMOGLOBIN BY USING COPPER SULPHATE SOLUTION**

#### **3.19.1. Purpose**

To provide guidance on the procedure of Haemoglobin estimation level to blood donors using the Copper Sulphate solution technique

#### **3.19.2. Scope**

This procedure provides guidance on haemoglobin estimation of blood donors using copper sulphate (CUS04) method in NBTS Blood collection teams and its satellites.

#### **3.19.3. Responsibility**

Trained qualified and competent certified registered medical personnel and other authorized medical personnel.

#### **3.19.4. Principle**

A blood droplet is allowed to fall into copper sulphate solution of a specific gravity 1.053 and the movement of droplet is observed, If the specific gravity is higher than solution, the drop will sink within 15 sec or else it will remain suspended for some time.

#### **3.19.5. Sample Requirements**

Capillary Blood

#### **3.19.6. Equipment**

Not applicable

#### **3.19.7. Materials**

**Reagents:** 70% Ethyl alcohol, Copper Sulphate solution with specific gravity of 1.053

**Consumables:** Sterile swabs, Picker, Sharp container, Capillary tubes, Gloves, Universal bottle, Waste containers and Timer

#### **3.19.8. Preparation of Copper II Sulphate solution**

- i. Weigh 170 gms of hydrous Copper Sulphate Powder/Crystals
- ii. Put into volumetric flask
- iii. Dissolve 170gms of hydrous Copper Sulphate Powder/Crystals with 1 litre of distilled water.
- iv. Mix well until all Crystals dissolves
- v. Label the solution as STOCK SOLUTION with Preparation date, Batch number and expiry date
- vi. *NB: Calculate expiry date six months from date of preparation*

- vii. Store and keep stock solution at room temperature in a tightly capped brown glass bottle.

### **3.19.9. Prepare Working Solution**

*To prepare 1 Litre of working solution;*

- Dispense 480mls of distilled water using measuring cylinder into a volumetric flask.
- Add 520mls of prepared stock solution using measuring cylinder
- Mix thoroughly

### **3.19.10. Storage and Stability**

Copper Sulphate working solution stored at room temperature in brown bottle in three months

### **3.19.11. Safety**

- i. Decontaminate working surfaces twice daily, in the morning and afternoon and when needed, all generated records are kept.
- ii. Adhere to safety precautions as stated in the Safety manual
- iii. All personal protective equipment (PPE) must be worn when performing this procedure.
- iv. All samples must be regarded as potentially infectious.
- v. Refer to National infection prevention and control Guidelines for health waste management and safety practice.
- vi. All spills should be wiped thoroughly using 0.5% sodium hypochlorite solution.

### **3.19.12. Calibration**

Not applicable

### **3.19.13. Quality Control**

**Reagent** : Test specific gravity of copper sulphate solution using Hydrometer

Accept the copper sulphate solution if the specific gravity is 1.053

Reject copper sulphate if specific gravity is not equal to 1.053

Record findings of the copper sulphate inspection and testing report form.

Then select sample with slightly below and slightly high with a cut off value of High (12.6 -13.0) g/dl and Low (12.0 – 12.4) g/dl.

Accept the copper sulphate solution, if drop of blood with haemoglobin level less than 12.5 g/dl floats and blood with haemoglobin level higher than 12.5g/dl sinks.

Perform corrective action if results are outside an acceptable limits

### **3.19.14. Procedure Steps**

Follow the actions described below step-by-step:

- i. Explain the Procedure to the Blood Donor
- ii. Welcome and greet the donor, offer a chair to seat
- iii. Explain the procedure and reassure the donor.
- iv. Select and clean Site
- v. Select donors' middle finger or the finger medial to the middle finger
- vi. Clean the upper top of right-side area with cotton wool swab soaked in 70% ethyl alcohol in a spiral movement starting at the intended site out ward
- vii. Leave it until dried do not blow the site
- viii. Remove the lancets cover
- ix. Using the index finger and thumb, squeeze and hold the donor's fingertip at the upper joint tightly and prick
- x. Wipe off the first drop of blood once with a dry swab
- xi. Draw blood into the Capillary Tube
- xii. Gently press the pricked fingertip to draw blood Note; Do not Squeeze the pricked finger because it may introduce tissue fluid, dilute blood and give false low Hemoglobin
- xiii. Hold Capillary tube at approximately 60 degrees and let the blood flow into the capillary tube up to not less than 3/4 capacity
- xiv. Avoid air entering the capillary tube by ensuring smooth flow and undisturbed flow of blood into the capillary tube
- xv. Close the upper tip of capillary tube by placing your finger tip
- xvi. Give clean dry swab to donor and instruct them to press finger with thumb till bleeding stops.
- xvii. Release a drop of Blood to Copper Sulphate Solution
- xviii. Hold capillary tube at least 1 cm above the surface of copper sulphate solution
- xix. Release your finger tip to allow one drop of blood freely into labeled container of fresh daily prepared and quality control copper sulphate solution.

### **3.19.15. Biological Reference Intervals**

Above or equal 12.5 g/dl

### **3.19.16. Interpretation and Reporting of Results**

Accept if HB is greater/equal than 12.5g/dl

Reject if HB is less than 12.5 g/dl

### **3.19.17. Limitations of The Procedure and Sources of Error**

Not applicable

### **3.19.18. Performance Characteristics**

Not applicable

### **3.19.19. Supporting Documents**

Sample collection manual, Quality manual, Safety manual

### **3.19.20. References**

AAB technical manual 12<sup>th</sup> edition, AfSBTC 4<sup>th</sup> Edition.

## **3.20. PROCEDURE FOR COMPATIBILITY TESTING**

### **3.20.1. Purpose**

This procedure provides instructions for performing compatibility testing, which is used to select blood and blood components that will not cause harm to the recipient (patient)

### **3.20.2. Scope**

This procedure is used in Blood Transfusion section when performing compatibility testing prior to issue of a unit of blood to recipient.

### **3.20.3. Responsibility**

The head of Blood Transfusion and competent medical laboratory personnel are responsible for ensuring this procedure is effectively implemented and maintained.

### **3.20.4. Principle**

This method is based on immunophenotyping principle. The known red cell antigens from donor are mixed with unknown antibodies from the recipient (patient) to detect if there is any incompatibility caused by ABO, Rhesus and/or other blood groups antibodies.

### **3.20.5. Sample Requirements**

- Patient/ recipient serum from a clotted blood sample in plain tube
- Donor cells from a segment tubing of the blood unit

### **3.20.6. Equipment**

Centrifuge, Water bath, timer, refrigerator

### **3.20.7. Materials**

<b>Reagent</b>	<b>Consumables</b>
Incomplete anti-D (IgG) Anti-Human Globulin Serum (AGS) Sensitized cell	Test tubes, Test tube rack, grease pencil, Beakers, Physiological Saline, Pasteur pipettes

### **3.20.8. Storage and Stability**

Venous blood must be used within 3 hours at room temperature then after should be refrigerated at 2-8°C. Blood Donor units should be stored at 1-6°C

### **3.20.9. Safety**

- i. Adhere to safety precautions as stated in the Safety manual
- ii. All personal protective equipment (PPE) must be worn when performing this procedure.
- iii. All samples must be regarded as potentially infectious.
- iv. Refer to National infection prevention and control Guidelines for health waste management and safety practice.

### **3.20.10. Calibration**

Calibration should be done as per schedule.

### **3.20.11. Quality control**

Quality Controls for Antihuman globulin should be done on a daily basis before performing patient samples..Internal quality control should be prepared from patient samples or known organisation.

### **3.20.12. Procedure Steps**

#### **Immediate Spin Saline Technique**

- i. Select a unit of blood from the blood bank storage with the same group as the recipient. If there is no unit with the same blood group as the recipient, blood group O packed red cells can be used as universal donor. Also recipients with AB blood group are considered as universal recipients of packed red cells.
- ii. Label a tube for each donor red cell suspension being tested with the patient's serum.
- iii. Add two drops of patient's serum or plasma to each tube.
- iv. Add one drop of donor cells suspension into appropriate test tubes
- v. Rinse the Pasteur pipette 5 times during transferring of cells and serum to avoid contamination
- vi. Mix the contents of the tube(s) and centrifuge at 1000rpm for 60 seconds.
- vii. Gently re-suspend the cell buttons and observe for haemolysis or agglutination.
- viii. Read, interpret, and record test results.
- ix. If compatible, proceed with Indirect Antiglobulin Technique

#### ***Interpretation and reporting:***

Agglutination or hemolysis means a positive (incompatible) test results

A smooth suspension of red cells after resuspension of the red cells button means negative results and indicates a compatible immediate spin cross match.

**Note:** *In emergency cases where the blood unit is required immediately, perform Immediate Spin Saline Technique. Issue the blood unit if it is compatible then proceed with Indirect Anti-globulin test. If there is any incompatibility, immediately call the ward to stop the transfusion and re-call the blood unit.*

### **3.20.13. Biological References Intervals**

Not applicable

### **3.20.14. Reporting and Interpretation of results**

#### **Interpretation of results**

Results should be reported in such a way that will indicate the recipient's blood group and the donor's blood unit number to which the donor's bloods is compatible or not compatible.

#### **Reporting of results**

Report as compatible when there is no agglutination or incompatible when there is no agglutination.

### **3.20.15. Limitation of the Procedure and Sources of Errors**

Hemolysis samples may lead to false negative results.

Patients who have had recent multiple transfusions may develop allo-antibodies that can interfere with antigen – antibody reactions

### **3.20.16. Performance Characteristics**

Refer to the method verification report.

### **3.20.17. Supporting Documents**

Quality manual, sample collection manual and safety manual

### **3.20.18. References**

Pam S. Helekar, D.P. Blackall et.al. American Association of Blood Bank 15 Edition, 1985. (method 3.1) and (method 3.2.1)

### **3.21. PROCEDURE FOR ABO BLOOD GROUPING DISCREPANCIES**

#### **3.21.1. Purpose**

The purpose of this procedure is to provide instructions for performing Initial investigation of ABO grouping discrepancies.

#### **3.21.2. Scope**

This procedure will be used for investigation of ABO grouping discrepancies in Blood transfusion unit.

#### **3.21.3. Responsibility**

Qualified and competent Medical Laboratory personnel are responsible for doing this test procedure. The head of section blood transfusion is responsible for ensuring the effective implementation and competency assessment for this procedure.

#### **3.21.4. Principle**

To be considered valid, the results of red cell grouping and serum grouping should agree. This method describes a general approach to the investigation of an ABO grouping discrepancy caused by either missing reactions or unexpected positive reactions

#### **3.21.5. Sample Requirements**

2-3mls blood in EDTA tube.

2-3mls clotted blood sample in plain tube

Centrifuge the sample according to anti-sera manufacturer instruction.

#### **3.21.6. Equipment**

Centrifuge machine, Microscope, Timer and Refrigerator

#### **3.21.7. Materials**

<b>Reagent</b>	<b>Consumables</b>
Standard anti-sera as controls. Standard ABO cells as controls Anti-A, Anti-B and Anti-AB sera Group A, B and O pooled cells 0.85% Or 0.9% Saline solution	Test tubes Pasteur pipette Waste Disposal box Test tube racks Beakers Microscope Slide



### **3.21.8. Storage and Stability**

Reagents are stored according to manufacturer instruction.

Samples are stored at 2-8 °C for the specified period in sample retention schedule.

### **3.21.9. Safety**

- i. All personal protective equipment (PPE) must be worn when performing this procedure.
- ii. All samples must be regarded as potentially infectious.
- iii. Refer to National infection prevention and control Guidelines for health waste management and safety practice.
- iv. All spills should be wiped thoroughly using 0.5% sodium hypochlorite solution.

### **3.21.10. Calibration**

Calibration of centrifuge and thermometers should be done.

### **3.21.11. Quality Control**

Performance of quality control for the reagents and source of Quality control materials will follow in ABO blood grouping procedure.

### **3.21.12. Procedure**

- i. Repeat ABO typing on the same sample. If initial tests were performed on red cells suspended in serum or plasma, testing should be repeated after washing red cells several times with saline.
- ii. Test a new sample. A new sample for testing should be requested when the ABO discrepancy reflects a disagreement between the current test results and a previous test result on record or when sample contamination is suspected.
- iii. Review the patient's medical history for medical conditions that could alter or interfere with ABO typing.
- iv. Review the results of plasma testing against autologous red cells and group O red cells in the antibody screen to evaluate potential interference by autoantibodies or alloantibodies. A direct antiglobulin test may be helpful.

### **3.21.13. Biological reference interval**

Not applicable

### **3.21.14. Reporting and interpretation of results**

Report POSITIVE and NEGATIVE.

### **3.21.15. Limitation of the Procedure and Sources of Error**

According to manufacturer instructions and sample collection manual.

### **3.21.16. Performance Characteristics**

This will follow the method verification report.

### **3.21.17. Supporting Documents**

Sample collection manual, quality manual and safety manual.

### **3.21.18. References**

- i. Cooling L. ABO, H, and Lewis blood groups and structurally related antigens. In: Fung M, Grossman BJ, Hillyer CD, Westhoff CM, eds. Technical manual. 18th edition. Bethesda, MD: AABB, 2014:291-315.

## **3.22. PROCEDURE FOR DIRECT ANTIGLOBLIN (COOMBS) TEST**

### **3.22.1. Purpose**

This procedure provides instructions for performing direct coombs test within the laboratory at blood transfusion section.

### **3.22.2. Scope**

This procedure is used in blood transfusion unit demonstrate in-vivo coating of red cells with antibodies. The DAT is used in investigating autoimmune haemolytic anemia, drug-induced hemolysis, hemolytic disease of newborn, and alloimmune reactions to recently transfused red cell

### **3.22.3. Responsibility**

The head of Blood Transfusion and competent medical laboratory personnel are responsible for ensuring this procedure is effectively implemented and maintained.

### **3.22.4. Principle**

All antibody molecules are globulins. anti-IgG combine mainly with FC portion of the sensitizing antibody molecules. the two fab sites of the AHG molecule form a bridge between adjacent antibody-coated cells to produce visible agglutination. cells that have no globulin attached will not be agglutinated. AHG will react with human antibodies and complement molecules that are bound to red cells or are present, free, in serum.

Unbound globulins may react with AHG, causing false-negative antiglobulin test. Unless the red cells are washed to remove unbound proteins before addition of AHG serum, the unbound globulins may neutralize AHG and cause a false-negative result.

### **3.22.5. Sample Requirement**

2- 3 ml of whole blood in EDTA tube

### **3.22.6. Equipment**

Centrifuge, refrigerator and microscope.

### **3.22.7. Maintenance**

Centrifuge, refrigerator and microscope. Maintenance should be performed timely.

### **3.22.8. Materials**

Reagent	Consumables
---------	-------------

Anti-human globulin serum (AHG'S) sensitized cells 0.9% normal saline	Test tubes, test tube rack, grease pencil, beakers, normal saline, pasteur pipettes, microscope slides and wash bottle Distilled water, Volumetric flask/Beaker Spatula, Marker pen, Gloves Plain paper/weighing paper
--	---

### 3.22.9. Storage and Stability

Venous blood must be used within 3 hours at room temperature then after should be refrigerated at 2-8°C. Blood Donor units should be stored at 1-6°C. Reagents should be stored at 2-8°C and sensitized cell should be stored at 2-8°C for 2weeks.

### 3.22.10. Safety

- i. Adhere to safety precautions as stated in the Safety manual
- ii. All personal protective equipment (PPE) must be worn when performing this procedure.
- iii. All samples must be regarded as potentially infections.
- iv. Refer to National infection prevention and control Guidelines for health waste management and safety practice.
- v. All spills should be wiped thoroughly using 0.5% sodium hypochlorite solution.

### 3.22.11. Calibration

Perform calibration of thermometer centrifuge, timer as per schedule.

### 3.22.12. Quality Control

Quality control for Antihuman globulin should be performed daily. Follow the following steps to run quality control of Antihuman globulin.

- i. Dispense 100µl of Anti human globulin sera (AGS)
- ii. Add 100µl of prepared sensitized cells into clean tube
- iii. Mix the contents of the tube according to manufacturer instructions.
- iv. Spin at 1000 RCF for 1 minute and macroscopically observe for agglutination
- v. Accept for use if there is agglutination.
- vi. Repeat the procedure and investigate the cause if no agglutination is observed.
- vii. Record all processes in record form.
- viii. The sensitized cells can be kept for 2-4 weeks at 1°C -6°C if suspended in Alservers solution, but appropriate controls must be used to ensure their quality is not compromised.

### 3.22.13. Procedure

#### ***Preparation of cells for the test***

- i. Take 5-7 drops of blood under test in a test tube
- ii. Wash the cell 3-4 times with normal saline to remove nonspecific plasma protein
- iii. By turning the test tubes upside down three to four times.
- iv. Use wash bottle instead of beaker to dispense normal saline during washing steps and decant the supernatant after each wash to avoid contamination
- v. Prepare 3-5% suspension of washed cells in normal saline by taking 3 drops of washed cells into a test tube and adding 97 drops of fresh normal saline for preparing 3%, and 5 drops of washed cells into 95 drops of fresh normal saline for preparing 5%, rinse the pasteur pipette 5 times during preparation and transferring of cells to avoid contamination

#### ***Preparation of Normal Saline***

- i. By using weighing scale and weighing paper measure 8.5 grams of Sodium chloride crystals
- ii. By using measuring cylinder measure 500mls of distilled water
- iii. Add measured 8.5grams of NaCl crystal in measuring cylinder containing 500mls of distilled water
- iv. Swirl measuring cylinder gently to mix the content
- v. When NaCl dissolve completely then add distilled water and make the final volume 1 liter.
- vi. Insert an air tightly stopper into the mouth of volumetric flask/measuring cylinder and shake gently to make the solution homogenous.
- vii. Transfer your solution into prepared container special for physiological saline and label it properly (name of solution, preparation date expired date, prepared by and storage temperature)

***NOTE: Prepare fresh Physiological saline everyday***

### 3.22.14. Preparation of O Sensitized Red Cells

- i. Select 2-3 units of group O positive cells for preparation of sensitized cells, take 1 ml from each unit.
- ii. Label tube "sensitized cells".
- iii. Transfer 1 ml of group O blood cells to the labeled tube.
- iv. Fill  $\frac{3}{4}$  of the labeled tube with normal saline or phosphate- buffered saline (PBS) or alservers solution
- v. Fill  $\frac{3}{4}$  of the second tube with normal saline for balancing.
- vi. Set the centrifuge at 3000rpm
- vii. Centrifuge for 5 minutes to pellet the cells.
- viii. Repeat three times while decanting the supernatant.
- ix. Add equal volumes of incomplete anti D and pooled O cells and mix

- x. Incubate at 37°C for 30 minutes
- xi. Wash the cells 3x in saline
- xii. Discard the final supernatant fluid
- xiii. Dispense 9.7 parts of normal saline or phosphate- buffered saline (PBS) or Alserver's solution into clean tube labeled sensitized cells.
- xiv. Transfer 0.3 parts of the washed sensitized red cells to the above tube labeled sensitized cells.
- xv. Cap or cover the tube with parafilm.
- xvi. Homogenize sensitized cells with normal saline or phosphate- buffered saline by gently inverting the tube ten times.

**Test procedure.**

- i. Add one drop of anti-human globulin serum (AHG) into a tube labeled with sample
- ii. ID number.
- iii. Add one drop of the prepared 5% cell suspension into the tube above.
- iv. Mix well centrifuge the tube at 1000rpm for 1 minutes
- v. Gently re-suspend the cell button and examine macroscopically for agglutination or hemolysis.
- vi. Examine the test cells microscopically to confirm the above results
- vii. If no agglutination or hemolysis is observed, add one drop of o sensitized cells as a positive control
- viii. Centrifuge the tube at 1000rpm for 1 minutes
- ix. Examine the contents of the tubes macroscopically as well as microscopically for the evidence of agglutination
- x. Presence of agglutination or hemolysis indicates a valid positive test.

**3.22.15. Biological Reference Intervals**

Not applicable

**3.22.16. Reporting and Interpretation of Results**

Report results as “direct coombs test – positive or negative”. Presence of agglutination or hemolysis indicate positive results. Absence of agglutination or hemolysis indicate Negative results.

**3.22.17. Limitations of the procedure and sources of error**

- i. Hemolysis samples may lead to false negative results.
- ii. Patients who have had recent multiple transfusions may develop allo-antibodies that can interfere with antigen – antibody reactions

**3.22.18. Performance Characteristics**

Refer to method verification.

### **3.22.19. Supporting Documents**

Quality manual, sample collection manual, safety manual and result management procedure.

### **3.22.20. References**

Pam S. helekar, D.P. blackall et.al. American association of blood bank 15 edition, 1985.

Coomb's reagent package insert

### **3.23. PROCEDURE FOR INDIRECT ANTIGLOBULIN (COOMBS) TEST**

#### **3.23.1. Purpose**

This procedure provides instructions for performing In-direct Antiglobulin Test (Indirect Coombs test).

#### **3.23.2. Scope**

Procedure is used in Blood Transfusion unit normally to test for IgG Rhesus antibodies that might have been produced by a Rhesus negative mother who has been immunized by a Rhesus positive child. The formed antibodies may cause hemolytic disease of new born

#### **3.23.3. Responsibility**

The head of Blood Transfusion and competent medical laboratory personnel are responsible for ensuring this procedure is effectively implemented and maintained.

#### **3.23.4. Principle**

When patient serum suspected to have immune antibodies are mixed with known O Positive washed red blood cells (antigen) and incubated at 37°C, washed then tested with AHG and the results shows agglutination.

#### **3.23.5. Sample Requirements**

2 to 5 ml of serum from clotted blood in plain tube, 3% sensitized red cells, 2-5 mls of pooled O cells

#### **3.23.6. Equipment**

Centrifuge, Refrigerator, 37°C water bath

#### **3.23.7. Materials**

<b>Reagent</b>	<b>Consumables</b>
Anti-Human Globulin Serum (AGS) sensitized cells 0.9% physiological saline	Test tubes, Test tube rack, grease pencil, Beakers, Physiological Saline, Pasteur pipettes

#### **3.0.1 Storage and Stability**

Venous blood must be used within 3 hours at room temperature then after should be refrigerated at 2-8°C. Blood Donor units should be stored at 1-6°C. Reagents like



Antihuman globulin should be stored at 2-8°C and sensitized cell should be stored at 2-8°C for 2weeks.

### **3.23.8. Safety controls**

- i. Temperatures for the room and refrigerator are recorded three times in 24 hours, 8 hours' interval each.
- ii. Adhere to safety precautions as stated in the Safety manual
- iii. All personal protective equipment (PPE) must be worn when performing this procedure.
- iv. All samples must be regarded as potentially infectious.
- v. Refer to National infection prevention and control Guidelines for health waste management and safety practice.
- vi. All spills should be wiped thoroughly using 0.5% sodium hypochlorite solution.

### **3.0.2 Calibration**

Calibration of equipment per should be done as per schedule.

### **3.0.3 Quality Control**

- i. Quality control for Antihuman globulin should be performed daily.
- ii. Quality Control of Antihuman globulin.
- iii. Dispense 100µl of Anti human globulin sera (AGS)
- iv. Add 100µl of prepared sensitized cells into clean tube
- v. Mix the contents of the tube according to manufacturer instructions.
- vi. Spin at 1000 RCF for 1 minute and macroscopically observe for agglutination
- vii. Accept for use if there is agglutination.
- viii. Repeat the procedure and investigate the cause if no agglutination is observed.
- ix. Record all processes in record form.
- x. The sensitized cells can be kept for 2-4 weeks at 1°C -6°C if suspended in Alservers solution, but appropriate controls must be used to ensure their quality is not compromised.

### **3.0.4 Procedure Steps**

- i. Pool O positive cells from at least 5 or more donors into one tube.
- ii. Wash the pooled O positive cells three to four times using physiological saline to remove adsorbed plasma proteins.
- iii. Prepare 3-5% cell suspension of O cells in normal saline.
- iv. Put two drops of serum /plasma into labeled tube marked "Test"
- v. Add two drops of 5% cells suspension in that labeled tube marked "Test" or with patient ID numbers if there is more than one sample.
- vi. Rinse the Pasteur pipette 5 times during preparation and transferring of cells to avoid contamination
- vii. Wash patient cells and prepare 3-5% cell suspension in normal saline.
- viii. Add two drop of patient cells in a tube labeled as Auto control.
- ix. Add two drops of patient serum to tubes Labeled auto control.

- x. Incubate the tubes at 37°C for 60 minutes. However, if there is Low Ionic Strength Solution (LISS) add two drops to each of the tubes above and incubate for 15minutes.
- xi. Wash both tube 4-5 times using normal saline
- xii. Use wash bottle instead of beaker to dispense normal saline during washing steps and decant the supernatant after each wash to avoid contamination
- xiii. After the last wash, decant the supernatant
- xiv. Add one drop of Anti Human Globulin serum (AHG)
- xv. Mix well
- xvi. Centrifuge the tube at 1000rpm for 60seconds
- xvii. Gently re-suspend the cell button and examine macroscopically for agglutination or hemolysis.
- xviii. Examine the test cells microscopically to confirm the above results
- xix. If no agglutination or hemolysis is observed, add one drop of O sensitized cells as a positive control
- xx. Centrifuge the tube at 1000rpm for 1 seconds
- xxi. Examine the contents of the tubes macroscopically as well as microscopically for the evidence of agglutination
- xxii. Presence of agglutination or hemolysis indicates a valid negative test.

### **3.23.9. Biological Reference Intervals**

Not applicable

### **3.23.10. Reporting and Interpretation of Results**

#### **Result interpretation**

Agglutination or hemolysis means Positive; Absence of agglutination or hemolysis means Negative.

#### **Reporting results**

Report as “In-direct Coombs test – Positive or Negative”.

### **3.23.11. Limitation of the Procedure and Sources of Errors**

- i. Hemolysis samples as this may lead to false negative results.
- ii. Patients who have had recent multiple transfusions may develop allo-antibodies that can interfere with antigen – antibody reactions

### **3.23.12. Performance Characteristics**

Refer to method verification.

### **3.23.13. Supporting Documents**

Quality manual, sample collection manual, safety manual and result management.

### **3.23.14. References**

- Pam S. Helekar, D.P. Blackall et.al. American Association of Blood Bank 15 Edition, 1985.
- Anti-Human Serum (Polyspecific) reagent insert, Span Diagnostic Ltd, 0712 ver

### **3.24. PROCEDURE FOR INVESTIGATION OF BLOOD TRANSFUSION REACTIONS**

#### **3.24.1. Purpose**

This procedure provides instructions for conducting a blood Transfusion Reaction Investigations.

#### **3.24.2. Scope**

This procedure is used in Blood Transfusion unit when investigating blood transfusion reaction.

#### **3.24.3. Responsibility**

The section head and qualified competent medical laboratory personnel are responsible for implementation of this procedure.

#### **3.24.4. Principle**

When a transfusion reaction occurs, the transfusion must be stopped immediately and the residual contents of the blood unit with freshly collected blood sample from the patient should be returned to the laboratory for transfusion reaction investigation.

#### **3.24.5. Sample Requirement**

Blood donor unit and recipient blood in plain tube

#### **3.24.6. Equipment**

Centrifuge and refrigerator machine

#### **3.24.7. Materials**

Anti-Sera A, B, AB and D, Combs Reagent, 0.85% Physiological Saline, Gloves, Laboratory coat, Test tubes, Pasteur pipettes, Test tube racks, Applicator stick, Blood Transfusion Investigation form

#### **3.24.8. Storage and Stability**

Whole blood must be used within 3 hours at room temperature then after should be refrigerated at 2-8°C. Blood Donor units should be stored at 1-6°C. Reagents stored in refrigerator at 2-8°C. Quality control materials are stored in refrigerator at 2-8°C.

#### **3.24.9. Safety**

- i. Adhere to safety precautions as stated in the Safety manual

- ii. All personal protective equipment (PPE) must be worn when performing this procedure.
- iii. All samples must be regarded as potentially infectious.
- iv. Refer to National infection prevention and control Guidelines for health waste management and safety practice.
- v. All spills should be wiped thoroughly using 0.5% sodium hypochlorite solution.

#### **3.24.10. Calibration**

Calibration of centrifuge and thermometer should be done as per the schedule.

#### **3.24.11. Quality Controls**

Controls are done daily in the morning before sample testing and whenever new control cells are prepared. Commercial anti-sera is quality controlled by reacting them with known 2-5% suspension of A, B, O, Rh( D) Positive and Rh (D) Negative control materials obtained from EQA materials or in house prepared control samples.

#### **3.24.12. Procedure Steps**

- i. A thorough check of the information on the blood unit label and patient identification should be performed to ensure the right blood unit was administered to the right patient
- ii. Visually observe the serum of the patient's pre-transfusion and post-transfusion reaction blood samples for hemolysis.
- iii. Perform ABO grouping and Rh typing on: Pre transfusion patient sample, Post transfusion patient sample and Donor blood unit
- iv. Repeat the crossmatch with the patient's pre transfusion and post transfusion samples.
- v. Perform the Direct Ant globulin Test (DAT) on patient's pre transfusion, post transfusion sample and donor unit. (Antibody screening)

#### **3.24.13. Biological Reference Intervals**

Not applicable

#### **3.24.14. Reporting of Result and Interpretation**

When Agglutination occurs this means Incompatible

Absent of agglutination this means Compatible

#### **3.24.15. Limitations of The Procedure and Sources of Error**

Hemolysed samples, lipemic samples, wrong sample and clotted sample affect the quality of results.

**3.24.16. Performance Characteristics**

Refers the method verification report.

**3.24.17. Supporting Documents**

Sample collection manual, safety manual, and quality manual.

**3.24.18. References**

Cuviello, Patrick Cuviello's Reference Manual for Medical Technology, Volume II,  
Third Edition Biological Reference Materials

### **3.25. PROCEDURE FOR PREPARATION OF BLOOD PRODUCTS**

#### **3.25.1. Purpose**

To provide guidance on preparation of Blood products that are; Cryoprecipitate, Cryo Poor Plasma, Packed Red Blood Cells, Fresh Frozen Plasma and Platelet Concentrate.

#### **3.25.2. Scope**

This SOP is intended to be used in the NBTS Laboratories.

#### **3.25.3. Responsibility**

Trained qualified competent Medical Laboratory staff

#### **3.25.4. Principle**

Blood product separation is done by centrifuge using sedimentation principle where whole blood is centrifuged in blood the particles/cells whose density is higher than that of the plasma sink (sediment), and particles that are lighter than it floats to the top. The greater the difference in density, the faster they move.

#### **3.25.5. Sample Requirements**

Not applicable

#### **3.25.6. Equipment**

Plasma extractor, refrigerator, deep freezer, tube sealer, refrigerated centrifuge

#### **3.25.7. Materials**

Anticoagulated blood, Gauze, Weighing /Digital Scale, 0.1% Sodium Hypochlorite, Waste bins, Strippers, Marker Pens and Pens, Balancing Materials, Personnel Protective Equipments, and Antiseptic, tube sealer.

#### **3.25.8. Storage and Stability**

Packed Red Blood cells (PRC) in CPDA anticoagulants should be refrigerated for up to 42 days at 2°C to 8°C. Fresh Frozen Plasma should be frozen stored at -18°C - 65°C for up to 7 years. Cryoprecipitate (CP) and Cryo-Poor Plasma at -18°C - 65°C – 80°C for up to 3 years. Thawed CP are stable for about 4- 6 hours. Platelet are kept at room temperature (18 - 24°C) under constant agitation for up to 7 days

#### **3.25.9. Safety**

- i. Adhere to safety precautions as stated in the Safety manual

- ii. All personal protective equipment (PPE) must be worn when performing this procedure.
- iii. All samples must be regarded as potentially infectious.
- iv. Refer to National infection prevention and control Guidelines for health waste management and safety practice.
- v. All spills should be wiped thoroughly using 1% sodium hypochlorite solution.

#### **3.25.10. Calibration**

Centrifuge and thermometer calibration should be done following calibration schedule.

#### **3.25.11. Quality Control**

Not applicable

#### **3.25.12. Procedure Steps**

##### ***Preparation of Cryoprecipitate and Cryo-Poor Plasma***

- i. Identify Blood Units for Cryoprecipitate and Cryo-Poor Plasma Preparation by selecting blood units that has been kept at 1°C to 6°C and that are within twenty-four hours from the time of collection.
- ii. Weigh and balance the units by using balancing materials
- iii. Pack the units into centrifuge buckets. Set refrigerated centrifuge temperature at 1°C to 6°C, and 5000 RCF for seven minutes.
- iv. Place the balanced buckets into refrigerated centrifuge. Close the centrifuge lid and start centrifugation until it automatically stops. DO NOT apply brakes
- v. Remove the packs gently from the buckets without agitating the sediment in order to avoid re-mix of packed cells and plasma. Observe for Conformance to Specifications that include; breakage or leakage, haemolysis and icterus
- vi. Flag non-conforming units with appropriate discard code using a marker pen and place in discard bin.
- vii. Withdraw the units in BECS or enter discard code in production register and discard report form if BECS is not in use.
- viii. Separate Plasma from the Packed Red Cells by placing the unit on Plasma Extractor.
- ix. Break primary pack outlet seal and allow the extractor to compress unit for plasma to flow into the satellite bag. Separate as much Buffy coat layer from the red cells into the plasma without introducing red cells into the plasma.
- x. Apply the clamp into tubing of the bag with Plasma
- xi. Allow some of plasma return into mother bag by releasing the clamp while weighing to remain with 225mls to 250mls of plasma, this will make PRC to attain haematocrit between 70% and 80%. Seal and detach the Packed Red Cells from the Plasma



- xii. Strip the tubing of the packed cells and make 3 knots apart or use sealer if available.
- xiii. Store PRC in quarantine area at 1°C to 6°C. Store Plasma for preparation of cryoprecipitate and cryo-poor plasma in quarantine area at -18°C to -25°C for overnight.
- xiv. Collect the Plasma from the freezer (-18°C to -25°C) and place in a blood bank refrigerator at 1°C to 6°C to thaw in a controlled environment. Leave the plasma for 16 to 24 hours while observing for slushy consistency achievement.
- xv. Weigh and balance the units using balancing materials and pack them into centrifuge buckets.
- xvi. Set refrigerated centrifuge temperature at 1°C to 6°C, and 3500 RCF for ten minutes.
- xvii. Carefully remove the units from the centrifuge
- xviii. Place the unit onto the shelf above workbench and place the transfer bag on the workbench.
- xix. Allow the Cryo-Poor Plasma to flow into the transfer bags by gravity by releasing the clamp. Leave approximately 50 – 70gms of Plasma in the original bag.
- xx. Clamp the tubing and weigh the bag containing the Cryoprecipitate product, allow Cryo-Poor Plasma to flow back into the bag if the right weigh was not attained until the weight range 50g – 70g.
- xxi. Create a seal on the tubing approximately 5cm from the Cryoprecipitate bag
- xxii. Verify that the original barcode on the Cryoprecipitate bag corresponds with the barcode numbers on the Cryo-Poor Plasma bag.
- xxiii. Detach the Cryoprecipitate product from the Cryo-Poor Plasma bag.
- xxiv. Create a seal on the tubing approximately 5cm from the Cryo-Poor Plasma bag
- xxv. Place the Cryoprecipitate Unit in a polystyrene basket lined with dry ice, for one hour if not available place it directly into freezer at -18°C to -25°C.
- xxvi. Label the PRC, Cryoprecipitate and Cryo-Poor Plasma with a product label that clearly shows the all the required information including, date bled, expiry date and time, product name, weight and blood unit number. Use BECS Alternative System if BECS is not in use.
- xxvii. Record the weight in the appropriate column on the production register. Label Blood product after TTIs and BGS testing.

### ***Platelet Concentrate (PC)***

Follow the actions described below step-by-step.

- i. Select blood units that have been kept at 20 to 24°C and that is with 8 hours from the time of collection.
- ii. Note: Units for Platelets should be kept at 20°C to 24°C and processed within eight hours from the time of collection.

- iii. Weigh and balance using balancing material. Pack the units in bucket. Set refrigerated centrifuge temperature at 22°C and allow the temperature to rise to approximately 22°C.
- iv. Set centrifuge program for light spin at 2000 RCF for three minutes.
- v. Place the balanced buckets. Close the centrifuge and start the centrifugation
- vi. Remove the units once centrifuge stops and observe for breakage, leakage, haemolysis and icterus.
  - a. Flag non-conforming product with appropriate discard code using a marker pen and place in discard bin.
  - b. Withdraw the units in BECS or enter discard code in production register if BECS is not in use.
- vii. Separate Plasma from the packed Red Blood Cells by placing the units in Plasma Extractor. Break primary pack outlet seal and allow the extractor to compress unit for plasma rich platelets to flow into the satellite bag.
- viii. Avoid red cells into the plasma bag, seal and detach the Packed Red Cells from the plasma
- ix. Strip the tubing of the packed cells and make 3 to 4 knots apart or use sealer if available.
- x. Store Packed Red Cells in quarantine area at 1 to 6°C
- xi. Set centrifuge program for heavy spin at 5000 RCF for ten minutes.
- xii. Weigh and balance using balancing material. Pack the Platelet Rich Plasma in bucket. Place the balanced buckets in the centrifuge. Close the centrifuge and start the centrifugation
- xiii. To separate Plasma from the Platelets Concentrate, gently place the unit in Plasma Extractor after centrifugation. Extract the supernatant plasma into the second empty satellite bag by squeezing gently without disturbing the platelets at the bottom of the bag.
- xiv. Place the Platelets bag on a weighing scale and release plasma to be between 50 and 70 mls of plasma with the platelets.
  - a. Flag platelets contaminated by red bloods cells with miscellaneous non-conformance code
  - b. Flagged units should be placed into discard bin.
- xv. Label the platelets with a product label if available that clearly shows the date of blood unit collection, expiry date and time, product weight and blood unit number.
- xvi. Label the extracted supernatant plasma as FFP. Record the weight in the appropriate column on the production register

***NB: Label Blood product after completion of TTIs and blood group serology testing.***

- xvii. Leave the prepared platelet units at the stationary phase, with the label side down, at 20°C to 24°C temperature for approximately 1 hour to allow the platelets to resume their discoid shape and disaggregate.
- xviii. Place the platelets on an agitator for one hour to ensure they are evenly suspended.

- xix. Observe for swirling phenomenon, which indicates good quality platelets
- xx. Strip the tubing several times, mixing tubing contents of the platelets bag.
- xxi. Seal off a segment of the tubing and disconnect it so that the platelets bag remains sterile.
- xxii. Place the platelets into the platelet agitator at 20°C to 24°C in the area designated for quarantined products.
- xxiii. Store the FFPs immediately in a freezer at -18°C to -25°C or below. Monitor FFP freezing after 24 hours and flag as outdated plasma if not frozen, flag with miscellaneous non-conformance code.

### ***Packed Red Blood Cells and Fresh Frozen Plasma***

***Note: Units for PRC and FFP preparation should be kept at 1°C to 6°C and processed within twenty-four hours from the time of collection.***

#### **Step 1: Identify Blood Units for PRC and FFP Preparation**

- i. Select blood units that has been kept at 1°C to 6°C and units that are within twenty-four hours from the time of collection.
- ii. Weigh and balance using balancing materials
- iii. Pack the units into centrifuge buckets
- iv. Set refrigerated centrifuge temperature at 1°C to 6°C, and 5000 RCF for seven minutes if platelet reach plasma will not be harvested.

#### **Step 2: Perform Centrifugation**

- i. Place the balanced buckets into refrigerated centrifuge
- ii. Close the centrifuge lid and start centrifugation
- iii. Allow the centrifuge to stop freely. DO NOT apply brakes
- iv. Remove the packs gently from the buckets without agitating the sediment in order to avoid re-mix of packed cells and plasma
- v. Observe units for breakage or leakage, haemolysis and icterus

#### **Step 3: Observe for Conformance to Specifications**

- i. Flag non-conforming units with appropriate discard code using a marker pen and place in discard bin.
- ii. Withdraw the units in BECS or enter discard code in production register and discard report form if BECS is not in use.

#### **Step 4: Separate Plasma from the Packed Red Cells**

- i. Place the unit on Plasma Extractor
- ii. Break primary pack outlet seal and allow the extractor to compress unit for plasma to flow into the satellite bag.
- iii. Separate as much Buffy coat layer from the red cells into the plasma without introducing red cells into the plasma
- iv. Allow some of plasma return into mother bag by releasing the clamp while weighing to remain with 225mls to 250mls of plasma, this will make PRC to attain haematocrit between 70% and 80%
- v. Seal and detach the Packed Red Cells from the Plasma

- vi. Strip the tubing of the packed cells and make 3 knots apart or use sealer if available.
- vii. Store PRC and FFP in quarantine area at 1°C to 6°C and -18°C to -25°C respectively.

**Step 5: Label and Record the Products**

- i. Label the PRC and FFP with a product label if available that clearly shows the date bled, expiry date and time, product name, weight and blood unit number.
- ii. Record the weight in the appropriate column on the production register.
- iii. Label Blood product after TTIs and BGS testing.
- iv. Store PRC in designated quarantine fridge at 1°C to 6°C.

**Step 6: Quarantine and Store the Products**

- i. Store FFP in designated quarantine freezer -18°C or colder
- ii. Monitor FFP freezing after 24 hours and flag as outdated plasma if not frozen, flag with miscellaneous non-conformance code.

***Preparation of Paediatric Bags From bags with integral satellites transfer bags***

- Follow the actions described below step-by-step:
  - ii. Review Clinician's Order or Blood Bank Order
  - iii. Obtain clinician's orders or Blood Bank order
  - iv. Review clinician's order or Blood Bank order
  - v. Note volume ordered
  - vi. Perform Compatibility Test
  - vii. Select appropriate blood unit based on patient's blood group
  - viii. Perform cross- match.
  - ix. Proceed to step 12.4.9 if compatible, if incompatible repeat 12.4.5
  - x. Perform Separation
  - xi. Invert the selected blood unit at least ten times (10x) to attain homogeneity of blood unit contents.
  - xii. Clip satellite transfer bags that are not going to be used by using clippers or pairs of forceps.
  - xiii. Break the tubing pot to allow the flow of blood into satellite transfer bag(s)
  - xiv. Allow volume of blood to flow into satellite transfer bag in accordance with clinician's order intended volume.
  - xv. Tie three to four knots or seal the pilot tubing of the filled satellite transfer bag after attaining required volume.
  - xvi. Label Pediatric Unit
  - xvii. Label the separated pediatric unit with the following details:
    - i. Name of the component.
    - ii. The unique numeric or alphanumeric identification.
    - iii. The date of the collection of the blood /component from the donor.
    - iv. Expired date.
    - v. Issue blood in accordance to procedure for issuing blood if order is received already.

- vi. Store prepared pediatric units at recommended temperature waiting for order

**Calculations**

$$RCF=28.38 \times R \times (RPM/1000)^2$$

- Where:  
RCF=relative centrifugal force (xg); R= radius in inches  
RPM= revolutions per minute

**3.25.13. Biological Reference**

Not applicable

**3.25.14. Interpretation and Reporting of Results**

Not applicable

**3.25.15. Limitation of the Procedure and Sources of Error**

Avoid haemolysed samples as this may lead to poor products.

**3.25.16. Performance Characteristics**

Not applicable

**3.25.17. Biological Reference Interval**

Not applicable

**3.25.18. References**

AABB Technical Manual 18th Edition, Guide to the preparation, use and quality Cryoprecipitate and Cryo-Poor Plasma

### **3.26. PROCEDURE FOR DETERMINATION OF WEAK A AND B BLOOD GROUP ANTIGENS, AND COLD ANTIBODIES**

#### **3.26.1. Purpose**

This procedure establishes step by step instructions for confirming suspected weak A or B subgroups using adsorption and elution.

#### **3.26.2. Scope**

This procedure is intended to be used in Blood transfusion unit for confirmation of suspected weak subgroups of A and B antigens

#### **3.26.3. Responsibility**

All qualified competent certified Medical Laboratory staff are responsible for implementing this procedure.

#### **3.26.4. Principle**

Prolonged incubation at low temperatures can enhance antibody binding and detection of weak ABO antigens and antibodies. Because it is often unclear whether an ABO discrepancy is the consequence of weak antigens or of antibodies, testing both red cells and serum in parallel is recommended.

#### **3.26.5. Sample Requirements**

- i. Centrifuge sample as recommended by manufacturer instructions.
- ii. Three times washed red cells to investigate missing red cell antigens.
- iii. Serum or plasma to investigate missing isoagglutinins.

#### **3.26.6. Equipment**

Centrifuge, refrigerator and Water bath

#### **3.26.7. Materials**

<b>Reagent</b>	<b>Consumables</b>
Monoclonal or polyclonal anti-A, anti-B, and anti-AB. A <sub>1</sub> , A <sub>2</sub> , B, and O reagent red cells (serum investigations). 6% albumin	Normal Saline at 2-6°C 10ml or higher capacity test tube. Pasteur pipettes.

#### **3.26.8. Storage and stability**

Preferred room temperature for 24hrs if greater than 24hrs store sample at 2-8°C following sample retention schedule. Reagents are stored in refrigerator at 2-8°C. Control materials are stored as samples.

### **3.26.9. Safety**

- i. Adhere to safety precautions as stated in the Safety manual
- ii. All personal protective equipment (PPE) must be worn when performing this procedure.
- iii. All samples must be regarded as potentially infectious.
- iv. Refer to National infection prevention and control Guidelines for health waste management and safety practice.
- v. All spills should be wiped thoroughly using 0.5% sodium hypochlorite solution.

### **3.26.10. Calibration**

Centrifuge, water bath and thermometers should be calibrated as per schedule

### **3.26.11. Quality Control**

Quality control will be performed following following blood grouping and Rhesus typing procedure.

### **3.26.12. Procedure**

- i. Place 1 drop of anti-A in a clean, labeled test tube.
- ii. Place 1 drop of anti-B in a separate, clean, labeled test tube.
- iii. Place 1 drop of anti-AB in a third clean, labeled test tube.
- iv. To each tube, add 1 drop of a 2% to 5% suspension (in saline, serum, or plasma) of the red cells to be tested.
- v. Incubate all tubes for 30 minutes at room temperature.
- vi. Centrifuge tubes according to reagent manufacturer's directions.
- vii. Gently resuspend cell buttons and examine for agglutination.
- viii. If no agglutination is observed, incubate tubes for 15 to 30 minutes at 4°C.
- ix. Centrifuge and examine for agglutination.

### **3.26.13. Biological Reference Interval**

Not applicable

### **3.26.14. Reporting of and Interpretation of Results**

No interpretation can be made if the 6% albumin control for spontaneous agglutination is positive or if cold autoantibody or alloantibody is detected.

### **3.26.15. Limitation the Procedure and Sources of Errors**

Avoid use of hemolysed or clotted samples

### **3.26.16. Performance Characteristics**

Refer the method verification report of this procedure.

### **3.26.17. Supporting Documents**

ABO grouping procedure, Quality manual, sample collection manual and safety manual.

### **3.26.18. References**

Cooling L. ABO, H, and Lewis blood groups and structurally related antigens. In: Fung M, Grossman BJ, Hillyer CD, Westhoff CM, eds. Technical manual. 18th edition. Bethesda, MD: AABB, 2014:291-315



## **3.27. PROCEDURE FOR PERFORMING ABO-RH GROUPING AND ANTIBODIES SCREENING BY USING NEO IRIS ANALYZER**

### **3.27.1. Purpose**

This procedure provides instructions for Processing Assays on the NEO Iris

### **3.27.2. Scope**

This SOP is intended to be used in NBTS Laboratories and authorized laboratory when running assays on Neo Iris

### **3.27.3. Responsibility**

All trained and competent laboratory personnel are responsible for implementing this procedure.

### **3.27.4. Principle**

The device has captured Solid phase technology Where by the wall are washed with PH-buffered, isotonic saline to remove unbound plasma/serum, indicator cells are added, and the micro plates are centrifuged. The indicator cells are antihuman globulin (AHG)-coated red blood cells.

### **3.27.5. Sample Requirements**

Blood collected in EDTA anticoagulants tube can be tested on the instrument. Serum samples obtained after blood clotting in plain tube can also be tested on the instrument for tests that do not require red cells.

Samples obtained from tubes containing neutral gel separators may produce falsely positive results and should therefore not be tested on the instrument.

Red blood cell donor unit segments can be tested on the instrument using the forward ABO and Rh blood grouping assays and Cross match, that exhibit a haemolysis grade of 3+ or greater must not be tested on the instrument.

Samples that exhibit excessive lipemia should not be tested on the instrument.

#### **Sample volume;**

At least 250µl of packed red blood cells need to be present in a sample tube to ensure that the probe picks up red blood cells and not plasma (only for those assays that require red blood cells).

At least 500µl of plasma or serum needs to be present in a sample tube to ensure that the probe picks up plasma or serum.

**Note:** *The dead volume, or the depth to which probes cannot reach, is 200 µl of sample.*

### **3.27.6. Equipment**

Neo Iris Analyser and centrifuge

### **3.27.7. Materials**

#### **Reagents**

ImmuClone Anti-a IgM, ImmuClone Anti-B IgM, ImmuClone Anti-AB IgM, ImmuClone Rh-Hr Control, ImmuClone Anti-D Rapid IgM, Immuclone Ant-D novaclone, CorQCTM EXTEND standard, Referencells-2(Group A1 and B), Referencells-1(Group A1), NEO Iris sample racks,

#### **Consumables**

NEO Iris reagent racks, NEO Iris transport frames, Stir balls, Micro-plate, Galileo Diluent and Wash buffer

### **3.27.8. Storage and stability**

Samples stored Preferred room temperature for 24hrs if greater than 24hrs store sample at 2-8°C following sample retention schedule. Reagents are stored in refrigerator at 2-8°C. Control materials are stored at 2-8°C.

### **3.27.9. Safety**

- i. Decontaminate working surfaces twice daily, in the morning and afternoon
- ii. Adhere to safety precautions as stated in the Safety manual
- iii. All personal protective equipment (PPE) must be worn when performing this procedure.
- iv. All samples must be regarded as potentially infectious.
- v. Refer to National infection prevention and control Guidelines for health waste management and safety practice.
- vi. Avoid any contact between hands and eyes and nose during sample **collection** and testing.

### **3.27.10. Calibration**

Perform Calibration when needed, perform calibration when new Quality Control received. Calibration of centrifuge will be done following laboratory calibration schedule.

### **3.27.11. Quality controls should be within acceptable limits**

Follow the actions described below step-by-step as follows:

- i. Select assay for QC and Load sources
- ii. Load all necessary reagents for the QC assay.
- iii. Press the Maintenance button on the main menu bar.
- iv. Select ABO Reagent QC item on the maintenance and verification action status screen, and then press the Start button.

- v. Press the continue button on the maintenance and verification preparation screen to access the resource overview window.
- vi. Select QC ABOD
- vii. Click plate on the plate column.
- viii. Load plate on the plate tower.
- ix. Click on plate ID
- x. Click on assay selection
- xi. Select QC ABOD
- xii. Press DONE
- xiii. Start the run by Pressing Start.
- xiv. Remove the plate from plate tower after QC Control is complete.
- xv. Read and interpret the results as follows;
  - a. If the QC passes, the system makes the assays that require these reagents available to be run.
  - b. If the QC fails, the reagent QC in question must be repeated with any issues resolved prior to starting any of the related assays.

### **3.27.12. Procedure Steps for Running patient samples**

#### ***Load Samples***

- i. Uncap sample tubes.
- ii. Click Load Samples button in the Start Run Assistant dialog.
- iii. Position sample tubes in appropriate rack and press them fully down to bottom of rack.
- iv. Ensure sample barcode labels on sample tubes can be seen through the gap on right of sample rack.
- v. Slide sample racks into sample loading bay one at a time using Lane with continuous green indicator LED.
- vi. Verify all barcodes have been scanned successfully.
- vii. Load further sample racks as needed if all barcodes have been scanned successfully.
- viii. Escan unread sample barcodes by handheld barcode scanner or by manual entry using the recall function as follows;
  - ix. Rescan with handheld barcode scanner by following steps below:
    - x. Remove rack with unread barcode.
    - xi. Press recall button to display sample IDs on the screen of last set of barcode reads.
    - xii. Scan missing unread barcode into relevant field with handheld scanner and reinsert rack into the lane with the continuous green LED.

#### ***Enter barcode manually by following steps below:***

- i. Remove rack with unread barcode
- ii. Press Recall button to display sample IDs on screen of last set of barcode reads.

- iii. Select the field that corresponds to the sample with the unread barcode so that it is highlighted blue.
- iv. Type sample ID number and press Enter
- v. Type sample ID number a second time and press Enter.
- vi. Reload rack in the lane focused with the continuous green LED.
- vii. Reenter sample ID if entries do not correspond.
- viii. Remove available rack(s) as indicated flashing Green LEDs in the 14-lane lane(s) to load additional samples during operation,

### **Select required Assays**

- i. Click rack in Rack area of loading bay dialog to select necessary rack. The samples in selected rack are displayed in sample IDs area.
- ii. Click on a sample ID to select specific sample.
- iii. Click a Donor assay profile button/option in test selection area to select an assay: ABO and RhD, Antibody screening (Pool cell).
- iv. Click ALL after making selection for first position.
- v. Enter donor ID in the addition input window manual by using hand scanner before loading donor rack. (if applying Crossmatch assay)
- vi. Repeat steps for all samples requiring that assays be manually assigned.
- vii. Click done on 14-lane Bay dialog when sample loading and assay assignment is finished. The system redisplay the start Run assistant dialog.
- viii. Verify check box is checked to the load samples button.

### **Load Consumables**

- i. Click load resources on start Run Assistant dialog.
- ii. Select an assay to run by clicking anywhere in the line of screen where the assay is displayed.
- iii. Verify system displays a green check mark (√) in column of a consumable.
- iv. Load consumables if system displays a red exclamation symbol (!) in one of the columns for a consumable.
- v. Open loading dialog for missing resources directly from resource overview window by clicking on the appropriate button above column.
- vi. Complete fields of appropriate loading dialog.
- vii. Close Loading dialog. Verify system redisplay the Resources Overview window.

### **Load Reagents and Controls**

- i. Uncap reagents and control.
- ii. Load reagents and controls required for planned assays into reagent racks, so that barcodes on vial labels are facing towards opening in right hand side of rack.
- iii. Add one stir ball into each vial containing cellular reagent.
- iv. Open loading bay dialog by clicking 5-lane bay or 14-lane bay area on machine monitor, dependent on reagent rack size being used.

- v. Load reagent racks into appropriate slots when indicator light is solid green. Wait for indicator light (LED) at front of the lane itself to change to continuous green before inserting a rack.
- vi. Change the lane that is activated for insertion of a rack by clicking one of the indicator buttons at the top of the lane as presented on the Loading Bay dialog.
- vii. Verify all barcodes are read. Hand scan or manually entry unread Barcodes using the recall function.
- viii. Press Done to exit the loading bay dialog when finished loading reagents

### ***Loading plates***

- i. Place plate in a NEO Iris transport frame
- ii. Position frame so that guiding groove is on right and the plate is inserted in to frame upright with well A1 at the top left corner. The barcode must be on left edge of the plate.
- iii. Ensure plate is correctly seated in frame depression.
- iv. Ensure required number of strips are inserted and all strips are inserted in correct orientation and pressed fully into position in strip carrier frame.
- v. Open door of loading tower.
- vi. Insert each of the required plate on its transport frame into vacant slot in loading tower that is illuminated solid green, If there are no free slots, remove the plates from any slots with flashing green indicator lights.
- vii. Ensure the frame is fully inserted into the tower position, close the loading tower door. This will also initiate a plate barcode read for all new plates.
- viii. Open plate tower dialog by pressing Plate Tower on machine monitor.
- ix. Verify strip pattern in Plate Tower dialog (strip selection tab) corresponds to strips in plates.
- x. Reload plates during operation:
- xi. Remove complete plates from loading tower as indicated by flashing green LEDs.
- xii. Dispose of used plates following standard laboratory practice
- xiii. Insert new plates into loading tower following steps as outlined assays.
- xiv. Confirm plates designated for processing are selected (In the Resource overview window). Selected rows are highlighted in blue.
- xv. Press Start button. The running man animation appears.
- xvi. The NEO Iris begins processing. The system displays the schedule (processing Steps) on the screen.

### ***Perform Weak D and High titer (Ts\_IgM\_A1 and Ts\_IgM\_B).***

#### **When automatic ordered**

- i. Click worklist tab to view list of samples ordered automatic for assay
- ii. Weak D and High titer (Ts\_IgM\_A1 and Ts\_IgM\_B) and click done.

#### **When ordering manually**

- iii. Click rack in Rack area of loading bay dialog to select necessary rack. The samples in selected rack are displayed in sample IDs area.

- iv. Repeat step
- v. Click on a sample ID to select specific sample.
- vi. Click a Donor assay profile button/option in test selection area to select an assay: Weak D or High titer (Ts\_IgM\_A1 and Ts\_IgM\_B)
- vii. Repeat steps for all samples requiring that assays be manually assigned
- viii. Click done on 14-lane Bay dialog when sample loading and assay assignment is finished. The system redisplay the start Run assistant dialog.
- ix. Verify check box is checked to the load samples button.
- x. Repeat step

### **3.27.13. Biological Reference Intervals**

Not applicable

### **3.27.14. Reporting and Interpreting Results**

Sample is automatically analysed and results released by the machine following the steps below.

#### ***Review Results.***

- i. Press Results button on main menu bar.
- ii. Press Sample view or Plate view button in view area of window to Select preferred view. Sample view allows viewing results by sample ID, while Plate view allows viewing results by plate ID.
- iii. Use the following options to narrow the results search:
- iv. Select From and To date drop-down lists to select a From or To date.
- v. Use the default of All to view results of all assays.
- vi. Enter the unique ID in the appropriate field for plate, sample or donation to find results for a specific plate, sample or donation ID. Selection will appear on the screen in a table below these fields.
- vii. Select the particular assay from the Assay field drop down menu to find results for specific assay. Selection will appear on the screen in a table below this field.
- viii. Select 'All Types', 'Unusual' or 'Normal' on Result Type to display the results of choice.

***Note 1: Only Normal results will be Approved and exported to an LIS***

***Note 2: For unusual results: re-inspect the sample integrity, re-centrifuge then Rerun the samples***

***Note 3: If unusual results still appear subject the samples to 'Manual resolving ABO Blood Group Discrepancy SOP***

- ix. Sort the columns in the table in ascending or descending by clicking on column headings.

- x. Press these buttons Details, Approve, Print, Export, Edit and Void to view test details, or to approve, print, edit or void test results that searched for and have highlighted in the table.
- xi. Click Close or Ok when finished.

**Export results to a LIS.**

- i. Ensure all results to be exported are approved.  
*Note: The system displays a dialog after a result is approved. The dialog gives an option to export results to the LIS.*
- ii. Select individual results to be exported using line check boxes or select all using Select All button
- iii. Press the export button.
- iv. Compare current results and previous records Of ABO and Rh D Results for repeat/regular donors
- v. Log in BECS
- vi. On the menu click laboratory
- vii. Select lists
- viii. Select analyzed Donations, window for analyzed donations will open up
- ix. Select date
- x. Select donation with blood group discrepancy on search, all donations/sample,
- xi. On the drop-down menu under donation type: select all donations
- xii. Select date
- xiii. Enter donation number or leave blank to capture any unit
- xiv. Click search and obtain data on discrepancy if any
- xv. Print if obtained results/data contain discrepancy
- xvi. Handle the discrepancies in accordance to procedure for corrective and preventive action

**3.27.15. Limitations of the procedure and sources of errors**

Avoid haemolysed samples.

**3.27.16. Performance Characteristics**

Refer to the method verification report of this procedure.

**3.27.17. Supporting Documents**

Quality manual, calibration schedule, sample collection manual and safety manual

**3.27.18. References**

- a. Immucor, Inc. NEO Iris Operator Manual NIS-OO1-100(or higher). Norcross, GA: 2018

- b. CLSI. Quality Management System: Development and Management of Laboratory Documents; Approved Guideline – Sixth Edition. CLSI document QMSO2 – A6. Wayne, PA: Clinical and Laboratory Standards Institute; 2013



### 3.28. PROCEDURE FOR ALBUMIN OR LISS-ADDITIVE INDIRECT ANTIGLOBULIN TEST

#### 3.28.1. Purpose

This procedure provides instructions for Albumin or LISS Additive Indirect Anti-globulin Test

#### 3.28.2. Scope

This procedure will be used for Albumin or LISS Additive Indirect Anti-Globulin Test at Clinical laboratory

#### 3.28.3. Responsibility

Qualified and competent Medical Laboratory personnel are responsible for doing this test procedure. The head of section Hematology is responsible for ensuring the effective implementation and competency assessment for this procedure.

#### 3.28.4. Principle

An indirect antiglobulin test (IAT) demonstrates in-vitro reactions between red cells and antibodies, and is used in antibody detection, antibody identification, crossmatching, and blood group phenotyping. The albumin method may reduce repulsive forces between cells and thus promote agglutination. Use of a LISS additive accelerates antibody binding **to red cells**.

#### 3.28.5. Sample Requirements

Serum or plasma may be used. The age of the sample must comply with pretransfusion sample requirements in *AABB Standards for Blood Banks and Transfusion Services*.

#### 3.28.6. Equipment

Centrifuge, Microscope, Refrigerator, Timers, and 37°C water bath

#### 3.28.7. Materials

Reagent	Consumables
Bovine albumin (22%). LISS, available commercially for this use. Antihuman globulin (AHG) reagent. Polyspecific or anti-IgG may be used unless otherwise indicated. Group O antibody detection cells. Pooled group O antibody-detection cells may be used only for donor	Test tubes. Pasteur pipettes. Glass slides. Disposal box.

testing. Testing of patient samples must be performed with unpooled cells. A 2% to 5% suspension of donor red cells in saline. IgG-coated red cells.	
--	--

### **3.28.8. Storage and Stability**

Store reagents following manufacturer instruction. Samples are stored at 2-8°C following sample retention schedule. Quality control materials are stored the same as samples.

### **3.28.9. Safety**

- i. Decontaminate working surfaces twice daily, in the morning and afternoon and when needed, all generated records are kept.
- ii. Adhere to safety precautions as stated in the Safety manual
- iii. All personal protective equipment (PPE) must be worn when performing this procedure.
- iv. All samples must be regarded as potentially infections.
- v. Refer to National infection prevention and control Guidelines for health waste management and safety practice.
- vi. All spills should be wiped thoroughly using 0.5% sodium hypochlorite solution.

### **3.28.10. Calibration**

Calibration of the equipment will be done as per calibration schedule

### **3.28.11. Quality Control**

The procedure used for the detection of unexpected antibodies in pre transfusion testing should be checked daily before sample testing with weak examples of antibody. Control sera can be prepared from reagent grade typing sera diluted with 6% bovine albumin to give 2+ reactions by an IAT. Human sources of IgG antibodies are also acceptable.

### **3.28.12. Procedure Steps**

- i. Add 2 drops of serum or plasma to properly labeled tubes.
- ii. Add an equivalent volume of 22% bovine albumin or LISS additive (unless the manufacturer's directions state otherwise).
- iii. Add 1 drop of a 2% to 5% saline-suspended reagent or donor red cells to each tube and mix.
- iv. For albumin, incubate at 37 C for 30 to 60 minutes. For LISS, incubate for 10 to 15 minutes per the manufacturer's directions.

- v. Centrifuge and observe for hemolysis and agglutination. Grade and record the results.
- vi. Wash the red cells three or four times with saline, and completely decant the final wash.
- vii. Add AHG to the dry red cell button according to the manufacturer's directions. Mix well.
- viii. Centrifuge and observe for agglutination. Grade and record the results
- ix. Confirm the validity of negative results by adding IgG-coated red cells.

### **3.28.13. Biological Reference Intervals**

Not applicable

### **3.28.14. Reporting and Interpretation of Results**

The presence of agglutination/hemolysis after incubation at 37 °C constitutes a positive test result.

The presence of agglutination after addition of AHG constitutes a positive test result. Antiglobulin test results are negative when no agglutination is observed after initial centrifugation followed by agglutination with the addition of IgG coated red cells and centrifugation. If the IgG coated red cells are not agglutinated, the negative result is invalid and the test must be repeated. Report results as Compatible or Incompatible.

### **3.28.15. Limitations of The Procedure and Sources of Error**

Avoid haemolysed samples as this may lead to false negative results.

Patients who have had recent multiple transfusions may develop allo-antibodies that can interfere with antigen – antibody reactions

### **3.28.16. Performance Characteristics**

Refer method verification report

### **3.28.17. Supporting Documents**

Quality manual, safety manual and sample collection manual.

### **3.28.18. References**

Levitt J, ed. Standards for blood banks and transfusion services. 29th ed. Bethesda, MD: AABB, 2014.

Downes KA, Shulman IA. Pre transfusion testing. In: Fung M, Grossman BJ, Hillyer CD, Westhoff CM, eds. Technical manual, 18th ed. Bethesda, MD: AABB, 2014:367-90.

### **3.29. PROCEDURE FOR PERFORMING BLOOD TRANSFUSION TRANSMISSIBLE INFECTIONS (TTIS) BY USING ALINITY ANALYZER**

#### **3.29.1. Purpose**

The purpose of this procedure is to provide guidance for running donor sample using Alinity s analyser

#### **3.29.2. Scope**

This procedure is applicable to NBTS Laboratories when running donor sample on Alinity s analyzer

#### **3.29.3. Responsibility**

Trained qualified and competent certified registered medical personnel and other authorized medical personnel.

#### **3.29.4. Principle**

The assay is an automated, two step immunoassay to detect qualitative IgG antibodies in plasma and serum samples using a chemiluminescent micro-particle immunoassay (CMIS). The resulting chemiluminescent reaction is measured as a relative light unit (RLU)

#### **3.29.5. Sample Requirements**

Plasma or serum

#### **3.29.6. Equipment**

Alinity s Analyzer, Centrifuge

#### **3.29.7. Materials**

**Reagents:** Alinity s reagent kits

**Supplies:** Sample rack, Rack tray

#### **3.29.8. Storage and Stability**

Store calibrator at 2-6°C

#### **3.29.9. Safety**

- i. Decontaminate working surfaces twice daily, in the morning and afternoon and when needed, all generated records are kept.
- ii. Adhere to safety precautions as stated in the Safety manual
- iii. All personal protective equipment (PPE) must be worn when performing this procedure.

- iv. All samples must be regarded as potentially infectious.
- v. Refer to National infection prevention and control Guidelines for health waste management and safety practice.
- vi. All spills should be wiped thoroughly using 0.5% sodium hypochlorite solution.

### 3.29.10. Calibration

Perform calibration of Alinity s Analyser as needed

#### i. Create manual calibration order

*a. Before starting procedure make sure that machine is in idle status*

- i. Go to Orders on the menu bar
- ii. Click Create Order on the Orders screen
- iii. Click Create Order on the Orders screen
- iv. Click the assay that you intend to calibrate under Assay Selection on the Calibration tab
- v. Select the path and lane to be calibrated under Reagent Selection tab.
- vi. Click the calibrator lot to be calibrated from the drop-down list Under Additional Selection tab
- vii. Click Add Order to save the calibration order
- viii. Click Order Status to view the calibration order

#### • Option 2

#### ii. Create automated calibration order

*a. Automated calibration ordering is available by using system configuration parameters.*

- iii. Create an automatic calibration by reading the calibrator I bar code by the bar code reader if the following conditions are met.
  - a) A calibration curve with a calibration status of or pending QC does not exist.
  - b) A calibration is not in process
- iv. Load calibrator(s) into calibrator and control rack (s)
- v. Load the calibrator bottle into the calibrator and control rack so that the bar code label is visible to the bar code reader.
- vi. Open the calibrator bottle flip cap and secure the cap to the rack
- vii. Load calibrator and control racks into priority bay
- viii. Take the rack off the priority bayh when the procedure is complete

***NB: calibrator rack will be un loaded when the procedure is complete***

- a. Review calibration status
  - i. Go to QC- Cal tab
  - ii. Select Calibration status

- iii. Check calibration status if they are in either of the following statuses
- ix. A successful procedure will indicate ACTIVE pending QC on reagents and on manual screen calibrator will be in green color
- x. A failed procedure will be indicate the fall outside of theh specifications. If an active curve exist for a reagent lot, sample and control results are calculated from the existing active calibration

### 3.29.11. Quality Control

Once calibration is accepted and stored it may be used for 14 days. During Control this time all subsequent samples may be tested without further need for calibration unless:

- A reagent with new lot number is used
- Daily quality control results are outside of quality control limit used to monitor and control system performance.
- Calibrator bottle are one-time use

### 3.29.12. Procedure Steps

Prepare blood sample

*Before starting procedure make sure that the analyzer is in Running status*

- a) Inspect donor sample for testing suitability criteria in accordance with sample acceptance/rejection criteria
- b) Reject sample that do not meet testing suitability criteria for Alinity s analyser
- c) Centrifuge sample at 2000 RCF for 15 minutes.
- d) Arrange blood sample into racks

*Ensure barcode label faces the open side of the rack for the barcode reader*

#### **Create a sample order**

- a) Automated sample ordering is available by using host computer downloads or host order queries. For automated ordering by a host computer, the system must be configured to communicate with the host. The Alinity s system in this facility is configured to perform this option **Testing Profile** area Displays the active testing profile.
- b) Select the Testing Profile area to run all of the assays in the profile

#### **Create Manual Sample Order**

- a) Tap Orders on the Menu screen
- b) Tap Create Order on the Orders screen.
- c) Enter sample 10 (SID) on the Sample tab  
**NB: The handheld bar code scanner can be used to enter the SID**
- d) Re-enter the SID to confirm the SID was entered correctly
- e) Enter the rack 10 and the position number.

**NB: The handheld bar code scanner can be used to enter the rack 10**

- f) Select an option in the Sampling Priority area.
- g) B: Samples designated as STA T must be loaded in the priority bay to be processed as STAT samples

**Select assay(s) to run by performing one of the following steps:**

- a) Tap the active test profile under Profile
- b) Select one or more of the assays in the list under Assays

**NOTE: In the Assay Options fly out, perform the following steps:**

- a) Select the number of replicates to order from the drop-down list.
- b) Tap the required dilution, if available.
- c) Tap Next to go to the next assay
- d) Tap Next to go to the next assay
- e) Tap Order Status to view the sample order (Optional)

**Start running donor sample**

- a) Open sample cap for sample loaded on racks (For automated sample bar code must be visible in the sample rack)
- b) Load sample racks on tray rack and load into any position on machine

**Note: Status of machine will change into processing and All parameters; order will change into pending to running.**

*For automated sample orders: Sample ordering will be automatic on placing the tray rack on the RSM*

- c) Run Release Control to release donor results

**3.29.13. Biological Reference Intervals**

Not applicable

**3.29.14. Interpretation and Reporting of Results**

Initial Results		
Initial Result (S/CO)	Interpretation	Retest Procedure
<1.00	Non-reactive	No retest required. Sample considered negative for HIV-1 p24 antigen and HIV-1/HIV-2 antibodies.
≥1.00	Reactive	Retest in duplicate
Final Interpretation		
Retest Results	Final Results	Final Interpretation
Both results <1.00	Non-reactive	Sample considered negative for HIV-1 p24 antigen and HIV-1/HIV-2 antibodies.
One or both results ≥1.00	Repeatedly reactive	Sample should be further tested by supplemental/confirmatory methods.

**3.29.15. Limitations of The Procedure and Sources of Error**

Hemolysis sample

**3.29.16. Performance Characteristics**

Not applicable

**3.29.17. Supporting Documents**

Alinity s System Operations Manual, sample collection manual

**3.29.18. References**

Alinity s System Operations Manual. 80000001-105 - 2018-02-19, System generated calibration records



### **3.30. PROCEDURE FOR PERFORMING BLOOD TRANSFUSION TRANSMISSIBLE INFECTIONS (TTI) BY USING ARCHITECT ANALYSER**

#### **3.30.1. Purpose**

The purpose of this procedure is to provide guidance on performing calibration, quality control and running donor samples Architect i2000 SR.

#### **3.30.2. Scope**

This procedure is applicable to NBTS Laboratories when performing calibration, running quality control and testing donor samples on Architect i2000SR analyser

#### **3.30.3. Responsibility**

Trained qualified and competent certified registered medical personnel and other authorized medical personnel.

#### **3.30.4. Principle**

The assay is an automated, two step immunoassay to detect qualitative IgG antibodies in plasma and serum samples using a chemiluminescent microparticle immunoassay (CMIS). The resulting chemiluminescent reaction is measured as a relative light unit (RLU)

#### **3.30.5. Sample Requirements**

Serum or Plasma

#### **3.30.6. Equipment**

Architect 2000i SR, Centrifuge

#### **3.30.7. Materials**

Wash buffer, Reaction vessels, Pre-trigger solution, Sample cups, Trigger solution, Septum, HIV, HBV, HCV and Syphilis reagents, Calibrators, Quality controls

#### **3.30.8. Storage and Stability**

Store calibrator at 2-6°C

#### **3.30.9. Safety**

- i. Adhere to safety precautions as stated in the Safety manual
- ii. All personal protective equipment (PPE) must be worn when performing this procedure.
- iii. All samples must be regarded as potentially infectious.

- iv. Refer to National infection prevention and control Guidelines for health waste management and safety practice.
- v. All spills should be wiped thoroughly using 0.5% sodium hypochlorite solution.

### **3.30.10. Calibration**

Perform calibration Architect 2000i SR and Centrifuge as needed

### **3.30.11. Quality Control**

This procedure is performed at least once every 24 hours each day of use. After every assay calibration process, a single sample of each control (for the particular assay calibrated) is tested. Follow the following steps to run quality control;

- i. Go to orders tab
- ii. Click control order option
- iii. Select single analyte
- iv. Scan carousel barcode or enter carousel number
- v. Enter position number on the carousel
- vi. Select assay
- vii. Select control assay levels
- viii. Click add order at the bottom of the screen
- ix. Go to order status
- x. Select all
- xi. Click print order list report
- xii. Click done
- xiii. Dispense controls into sample cups in order of carousel number, position number and specific assay volume on the order list print out
- xiv. Insert carousels with controls in the priority bay of the machine
- xv. Start running controls by clicking the processing module and sample handler which should be in ready status then press F8/Run tab
- xvi. If the processing module and the sample handler are in running
- xvii. Mode, control processing will start automatically

### ***Review Quality Control Results***

- i. Go to QC-Cal tab when QC processing is completed
- ii. Click QC results review
- iii. Check for flags. Should there be no flags, the QC passed
- iv. Go to QC-Cal
- v. Click Levey Jennings graph
- vi. Select assay
- vii. Click done
- viii. Review the control results in accordance with laboratory Westgard rules

- ix. Add details/comments to control values (e.g passed, or reasons and actions taken for control results that are outside specifications) by following steps below
  - x. Select the particular control point result on the Levey Jennings graph
  - xi. Click F5/Details
  - xii. Add comments by typing

### **3.30.12. Procedure Steps**

- i. Go to orders, Select patient order
- ii. Click single analyte
- iii. Scan carousel barcode or enter carousel number
- iv. Enter sample position number on the carousel
- v. Enter sample by scanning sample tube barcode or by entering sample ID by typing using keyboard
- vi. Select assay(s). If all parameters are required, you may click donor to select all assays required for donor testing
- vii. Click add order at the bottom of the screen
- viii. Load carousel with donor samples on the routine bay or priority bay for urgent samples

### **3.30.13. Review Donor Results**

- i. Go to results, Click results review.
- ii. You can sort the columns in the results table in ascending or descending order by clicking on column headings
- iii. Click Select all and F4/Print to get a printed copy of the results (Optional)
- iv. Release results to storage by selecting all and click release

### **3.30.14. Biological Reference Intervals**

Not applicable

### **3.30.15. Interpretation and Reporting of Results**

A successful procedure will indicate ACTIVE pending QC on reagents and on main menu screen calibrator will be in green color. A failed procedure will indicate the values fall outside of the specifications.

### **3.30.16. Limitations of The Procedure and Sources of Error**

Not applicable

### **3.30.17. Performance Characteristics**

Not applicable

### **3.30.18. Supporting Documents**

Alinity s System Operations Manual.

### **3.30.19. References**

Alinity s System Operations Manual. 80000001-105 - 2018-02-19, System generated calibration records

## **CHAPTER 4: HAEMATOLOGY**

---

### **4.1 PROCEDURE FOR SICKLING SCREENING TEST**

#### **4.1.1 Purpose**

The purpose of this procedure is to provide instruction for performing a screening test to determine abnormal type of Haemoglobin called Haemoglobin S in blood.

#### **4.1.2 Scope**

This procedure is used by all trained laboratory staff while performing sickling test in the Laboratory

#### **4.1.3 Responsibility**

Qualified, trained and competent Medical Laboratory Scientist, Technologist and Technician are responsible for doing this test procedure.

Section heads are responsible for ensuring the effective implementation and competency assessment for this procedure

#### **4.1.4 Principle**

When a drop of blood is sealed between a cover slip and a slide, the decline in oxygen tension due to oxidative processes in the blood cells leads to sickling. In this method added with blood drop chemical reducing agents such as sodium met bisulphite. This rapidly reduces oxyhemoglobin to reduced haemoglobin, and then this will be accelerating sickling.

#### **4.1.5 Sample Requirements**

3 - 4 ml of venous whole blood collected in EDTA tube (purple top vacuum). Sample must be free from haemolysis, lipemia and icterus.

#### **4.1.6 Equipment**

Light Microscope, and Hot plate

#### **4.1.7 Materials**

Freshly prepared 2% Sodium Metabisulphite (Diluting 0.2gm in 10ml of distilled water). Vaseline/paraffin wax, Pipette, Cover glass, Glass slide and Applicator stick

#### **4.1.8 Storage and Stability**

Processed whole blood is stable at 2°C to 8°C for 3 days.

Reagents are freshly prepared and stored at room temperature on daily basis. Do not use reagents that is more than 24 - hour post preparation.

#### **4.1.9 Safety**

Adhere to safety precautions as stated in the Safety manual/IPC guideline

All personal protective equipment (PPE) must be worn when performing this procedure.

All samples must be regarded as potentially infections.

#### **4.1.10 Calibration**

Not Applicable

#### **4.1.11 Quality Control**

Known positive control samples and negative control samples should be tested the same way as patient sample.

#### **4.1.12 Procedural Steps**

- i. Place one drop of the blood to be tested in a glass slide.
- ii. Add 1- 2 drops of freshly prepared 2% sodium met bisulphite to the drop of blood and mix well with an applicator stick.
- iii. Place a cover glass on top of the sample and press down lightly on it to remove any air bubbles and to form a thin layer of the mixture. Wipe of the excess sample.
- iv. Carefully rim the cover glass with molten paraffin wax or Vaseline, completely sealing the mixture under the cover slip.
- v. Incubate for 24 hours at room temperature, or for one hour at 37°C.
- vi. Examine the prepared glass slide for the present of sickle cells after one hour using 40 X objective.
- vii. If there is negative findings within one hour, allow the prepared slide to stand at room temperature for 24 hours, and examined under microscopy

#### **4.1.13 Biological Reference Interval**

Not applicable.

#### **4.1.14 Interpretation and Reporting Of Results**

- Report **Positive** when the presence RBCs appear as moon shaped or shaped like a “C” showing they are sickle cells.
- Report **Negative** when the presence RBCs appear round Normal looking red cells
- The results should be interpreted along with other clinical features. Further tests might be necessary to confirm the disease condition.

#### **4.1.15 Limitation of the Procedure and Sources of Errors**

Haemolysed samples. Iron deficiency or blood transfusions within the past 3 months can cause a false negative result

#### **4.1.16 Performance Characteristics**

Refers to method verification report

#### **4.1.17 Supporting Documents**

Sample collection manual

#### **4.1.18 References**

Monica Cheesbrough Handwrite

## **4.2 PROCEDURE FOR URIT-12 HEMOGLOBIN METER**

### **4.2.1 Purpose**

This procedure is used to describe step by step on how to operate the URIT-12 Haemoglobin Meter using human whole blood sample in the laboratory.

### **4.2.2 Scope**

This procedure is applied in testing hemoglobin parameter using human whole blood sample in the haematology department/section in the laboratory

### **4.2.3 Responsibility**

A trained and competent laboratory scientist, laboratory technologists and assistant laboratory technologists are responsible for performing this procedure.

The head of section or assigned personnel will be responsible for ensuring that this procedure is effectively implemented.

### **4.2.4 Principle**

The URIT-12 Hemoglobin Meter utilizes optical reflectance for determination of the total hemoglobin. A drop of whole blood is applied to the test spot on the strip, blood immediately disperses within the membrane contacting the reagent, then reaction product could absorb spectrum in the range of 500nm – 600nm. The meter's optical detector automatically measures the change in membrane reflectance. The intensity of reflectance is inversely proportional to the hemoglobin concentration. The meter calculates and displays the total hemoglobin concentration in gram/decilitre (g/dL) in 12 seconds based on mathematical conversion.

### **4.2.5 Sample Requirements**

Fresh capillary or EDTA-anticoagulated venous whole blood

### **4.2.6 Equipment**

URIT-12 Hemoglobin Meter

### **4.2.7 Materials**

The materials required in this procedure are Clean gloves, Laboratory coats, Micropipettes, Cuvetes, Sharp container, Pricker and Alcohol swab

### **4.2.8 Storage and Stability**

Anticoagulated blood is stable up to 72 hours at 2-8 °c

### **4.2.9 Safety**

- Personnel Protective Equipment must be worn at all times
- All samples must be treated as potentially infectious.
- Adhere to safety precautions as stated in the Safety manual/IPC guideline

### **4.2.10 Calibration**

Not Applicable

### **4.2.11 Quality Control**

Use Hemoglobin HQ-A Control Solution or known higher and low concentration made in-house to run on weekly basis to determine the accuracy of the patient results.

#### **4.2.12 Procedural Steps**

- i. Massage the patient's middle or ring finger from knuckle up to the tip to stimulate blood flow
- ii. Insert the test strip into the strip holder with the notched end in first and the hole facing up. The notched end on the top of strip should no longer be visible when test strip is inserted correctly and fully
- iii. Perform finger prick. Avoid "Milking" Apply light pressure to obtain one drop of blood.
- iv. Take 13-15 $\mu$ l of whole blood with capillary tube or transfer pipette
- v. Rapidly drip the blood into the sample spot on the strip when the meter shows blood symbol and ensure the test strip is covered by blood sample completely.
- vi. During the test do not disturb or move the meter or strip, even press any key of meter
- vii. The test results will be displayed in less than 30 seconds
- viii. Record the test results displayed on the machine.
- ix. Remove the test strip and immediately dispose off into highly infectious waste container.

#### **4.2.13 Biological Reference Intervals**

Infant 14.0 - 22.0g/dl, Children 11.1 - 14.1g/dl, Adult male 13.0 -17.0g/dl, Adult female 12.0-15.0g/dl

#### **4.2.14 Interpretation and Reporting Of The Results**

**Interpretation** of results

Interpretation of the results is based on the biological reference intervals.

**Reporting of results**

The obtained results will be reported in g/dl.

**Critical results:** HB  $\leq$  (5.07) g/dl is considered as critical and communicate with clinician

#### **4.2.15 Limitation of the Procedure and Sources of Errors**

Only whole blood or EDTA anticoagulated blood should be used.

#### **4.2.16 Performance Characteristics**

Refer into method verification report

#### **4.2.17 References**

URIT – 12 Hemoglobin meter Operation Manual

### **4.3 PROCEDURE FOR DETERMINATION OF HAEMOGLOBIN LEVEL USING HEMOCHROMAX PLUS**

#### **4.3.1 Purpose**



The procedure provides instructions to laboratory staff on operation of Hemochroma Plus Machine.

#### **4.3.2 Scope**

This procedure is applicable when performing quantification of Haemoglobin (Hb) concentration in Hospital Laboratory.

#### **4.3.3 Responsibility**

Qualified, trained and competent Medical Laboratory Scientist, Technologist and Technician are responsible for doing this test procedure. Section heads are responsible for ensuring the effective implementation of this procedure.

#### **4.3.4 Principle**

The hemochroma PLUS analyser utilizes a dual wavelength LED light sources by which the haemoglobin absorbance is detected and converted into an electrical signal. The signal is direct proportional to the amount of haemoglobin present in the blood sample.

#### **4.3.5 Sample Requirements**

Whole blood, capillary or venous ant coagulated collected blood into EDTA tube.

#### **4.3.6 Equipment**

Hemochroma PLUS machine

#### **4.3.7 Materials**

Hemochromax Plus Micro calibrator cuvette, Calibrator ID chip cuvettes, Gauze, 70% methylated spirit and Blood lancet or prickers

#### **4.3.8 Storage and Stability**

Anticoagulated blood is stable up to 3 days at 2-8 °c

#### **4.3.9 Safety.**

- Adhere to safety precautions as stated in the Safety manual/IPC guideline
- All personnel must be worn protective equipment (PPE) when performing this procedure.
- All samples must be regarded as potentially infections.

#### **4.3.10 Calibration**

It should be done when the machine is not working properly or when provides a doubt result.

#### **4.3.11 Quality Control**

Use commercial IQC materials or known higher and low concentration made in-house to run on daily basis before performing the patient sample

#### **4.3.12 Procedure**

- i. Establish good relationship with the patient

- ii. Make sure the patient is sitting comfortably
- iii. Lightly massage to stimulate circulation. Only use the middle or ring finger. The patient should not wear the ring on that finger
- iv. Press lightly and draw finger-prick blood into a micro cuvette by bringing the cuvette in contact with the blood drop on the fingertip and puncture the side to a depth of cuvette.
- v. Remove any excessive blood from the outside of the cuvette.
- vi. Insert the cuvette containing blood sample to the Hb machine
- vii. Wait until displaying of the test results and record the findings into the system and register book
- viii. Pull the cuvette holder out to its loading position and discard the used microcuvette in sharp box

#### **4.3.13 Biological Reference Interval**

Infant 14.0 - 22.0g/dl, Children 11.1 - 14.1g/dl, Adult male 13.0 -17.0g/dl, Adult female 12.0-15.0g/dl

#### **4.3.14 Interpretation and Reporting of Results**

**Interpretation** of results

Interpretation of the results is based on the biological reference intervals.

**Reporting of results**

The obtained results will be reported in g/dl.

**Critical results:** HB  $\leq$  (5.07) g/dl is considered as critical and communicate with clinician

#### **4.3.15 Limitation of the Procedure and Sources of Errors**

- i. Only whole blood should be used
- ii. Air bubbles in the optical eye caused by inadequate filling of the cuvettes may lead into false results

#### **4.3.16 Performance Characteristics**

Refer to method verification report

#### **4.3.17 Supporting Documents**

Sample Collection Manual, Safety Manual,

#### **4.3.18 References**

Monica Cheesbrough. District laboratory practice in tropical countries, Part 2. 2000.  
Hemochromax PLUS package insert  
Hemochromax PLUS user manual

### **4.4 PROCEDURE FOR DETREMANATION OF HEMOGLOBIN LEVEL USING HEMOCUE 201+ MACHINE**

#### **4.4.1 Purpose**

This procedure provides instructions for the performance of Haemoglobin Estimation using Hemocue 201+ machine.

#### **4.4.2 Scope**

This procedure applies to all competent laboratory staffs during determination of haemoglobin level by using Hemocue 201+ machine.

#### **4.4.3 Responsibility**

Qualified, trained and competent health laboratory practitioners in the laboratory are responsible for implementation of this procedure.

#### **4.4.4 Principle**

The reaction in the microcuvette is a modified azidemethemoglobin reaction. The erythrocytes are haemolysis to release the haemoglobin. The haemoglobin is converted to methoglobin and the combined with azide to form azide methoglobin. The measurement takes place in the analyser in which the transmittance is measured the absorbance and haemoglobin level is calculated. The absorbance is directly proportional the haemoglobin concentration

#### **4.4.5 Sample Requirements**

Capillary whole blood sample or Anti-Coagulated Whole blood (collected in EDTA anticoagulant)

#### **4.4.6 Equipment**

Hemocue 201+ machine

#### **4.4.7 Materials**

Hemocue Hb 201+ microcuvette, Lancet/Pricker for capillary sample, Pipette or any other transfer device for venous sample or control materials

#### **4.4.8 Storage and Stability**

Ant-Coagulated whole blood is stable up to 4 hours at room temperature and up to 24 hours at 4°C– 8°C.

#### **4.4.9 Safety**

- Personnel Protective Equipment must be worn at all times
- All samples must be treated as potentially infectious.

#### **4.4.10 Calibration**

Not Applicable

#### **4.4.11 Quality Control**

The Hemocue Hb 201+ has an electronic self-test daily IQC or the use of known higher and low concentration made in-house can also be applied.

#### **4.4.12 Procedural Steps**

- i. Establish good relationship with the patient
- ii. Make sure the patient is sitting comfortably
- iii. Lightly massage to stimulate circulation. Only use the middle or ring finger.  
The patient should not wear the ring on that finger

- iv. Press lightly on the fingertip and puncture the side to a depth of cuvette.
- v. Remove any excessive blood from the outside of the cuvette.
- vi. Insert the cuvette containing blood sample to the Hb machine
- vii. Wait until displaying of the test results and record the findings into the system and register book
- viii. Pull the cuvette holder out to its loading position and discard the used microcuvette in sharp box

**Note:** *The microcuvette should be filled within 3 minutes after it has been taken out of its package.*

#### **4.4.13 Biological reference Intervals**

Infant 17.0-22.0g/dl, Children 11.0-13.0g/dl, Adult male 13.0 -17.0g/dl, Adult female 12.0-15.0g/dl

#### **4.4.14 Interpretation and Reporting of Results**

**Interpretation** of results

Interpretation of the results is based on the biological reference intervals.

**Reporting of results**

The obtained results will be reported in g/dl.

**Critical results:** HB  $\leq$  (5.07) g/dl is considered as critical and communicate with clinician

#### **4.4.15 Limitation of the Procedure and Sources of Error**

- Only whole blood should be used
- Air bubbles in the optical eye caused by inadequate filling of the cuvettes
- Delayement in transfer of filled cuvettes with blood into HB machine

#### **4.4.16 Performance Characteristics**

Refers into method verification report

#### **4.4.17 Supporting Documents**

Waste Management Procedure /IPC guideline, Quality Control Result Procedure

#### **4.4.18 References:**

Monica Cheesbrough. District laboratory practice in tropical countries, Part 2. 2000. Hemocue Hb 201+ cuvette kits insert and use manual.

### **4.5 PROCEDURE FOR CD 4 COUNT TEST BY USING BD FACS PRESTO**

#### **4.5.1 Purpose**

The purpose of this procedure is to provide detailed information on how to analyse and detect CD4 T Cell enumeration on blood sample by using BD FACS presto.

#### **4.5.2 Scope**

This procedure applicable in haematology to analyse and detect CD4 T Cell by using BD FACS presto.

### **4.5.3 Responsibility**

Qualified, trained and competent Medical Laboratory Technician and Technologist are responsible for doing this test procedure. Section heads are responsible for ensuring the effective implementation and competency assessment for this procedure.

### **4.5.4 Principle**

The BD FACS Presto™ cartridge the CD4/%CD4/Hb cartridge contains dried fluorochrome-conjugated antibody reagents. When blood reacts with the reagents, the antibodies in the reagent bind to the surface antigens on the BD FACS Presto Cartridge: lymphocytes and monocytes. After the incubation period, the cells are analysed on the BD FACS Presto Near-Patient CD4 Counter (the instrument). The software identifies the cell populations of interest and calculates CD4 absolute counts, CD4 percentages of lymphocytes, and haemoglobin concentration. The system measures total haemoglobin by spectrophotometric method, using absorbance at an isobestic point for oxyhemoglobin and deoxy-hemoglobin, with Correction for scatter.

### **4.5.5 Sample Requirements**

Blood sample on K2EDTA vacuum tubes. All K2EDTA samples must be received and set up within 24 hours from collection time.

### **4.5.6 Equipment**

BD FACS Presto

### **4.5.7 Materials**

<b>Reagent</b>	<b>Consumables</b>
BD FACS presto cartridge	Blue and yellow tips BD FACS presto print out paper BD disposable 100 µl Pipette

### **4.5.8 Storage and Stability**

- Do not refrigerate whole blood SAMPLE before sample preparation.
- Do not use previously fixed and stored samples.

### **4.5.9 Safety**

- Blood samples may contain infectious agents that are hazardous to your health. Observe Standard Universal precautions.
- Ensure the instrument and environment you working are kept clean and free from infectious substance such as human blood to avoid contamination.
- Spills should be immediately disinfected with 0.5% Sodium Hypochlorite Solution.

### **4.5.10 Calibration**

Not Applicable.

### **4.5.11 Quality Control**

BD Facs presto has internal electronic self-test for IQC or the use of known higher and low CD4 counts made in-house can also be applied

#### **4.5.12 Procedural Steps**

- i. Open the cartridge package and label the patient ID on to the cartridge.
- ii. Face the inlet port up.
- iii. Invert the tube 10 times to mix the contents well.
- iv. Use the pipette to obtain the sample.
- v. Gently squeeze the bulb on the pipette to form a drop of blood on the tip of the pipette.
- vi. Carefully dispense the sample into the inlet port. Hold the cartridge by its ridges only.
- vii. Make sure the blood reaches the top of the inlet port. If necessary, gently squeeze the bulb on the pipette to dispense more blood.
- viii. Make sure the cartridge is level, with the barcode side up, at all times. Make sure that blood appears in the part of the channel not covered by the channel protector, next to the containment zone.
- ix. Discard the pipette into a biohazard us waste container.
- x. Close the cartridge cap securely and Set the on-board timer.
- xi. Place the cartridge, barcode side up, on the work station
- xii. Press the Run Test tab.
- xiii. Press Patient ID.
- xiv. Enter the patient's ID and press Accept.
- xv. The Confirmed Patient ID screen opens.
- xvi. Press Accept and Insert the cartridge:
- xvii. Select your Operator ID and press Accept. Then cartridge door on the instrument opens will open.
- xviii. Note: If possible, complete the following two steps within 30 seconds.
- xix. Remove the channel protector from the cartridge.
- xx. Hold the cap with the channel facing upwards.
- xxi. Insert the prepared cartridge into the cartridge door. The cartridge door closes.
- xxii. Press Accept to eject the cartridge within 30 seconds.

#### **4.5.13 Biological Reference Interval**

<b>Analyte</b>	<b>Gender</b>	<b>Reference interval</b>	<b>SI UNIT</b>
Absolute CD 4 count	Male	462 – 1306	cells/uL
	Female	440 – 1602	cells/uL
%CD4 of lymphocytes	Male	29 – 54	%
	Female	32 – 55	%
HAEMAGLOBIN	Male	13.5 – 18.0	g/dL
	Female	12.0 – 16.0	g/dL

#### **4.5.14 Interpretation and Reporting of Results**

- **Interpretation of results**
  - The results are displayed on the screen and print automatically.
- **Reporting of Results**
  - Report the obtained results as displayed on the screen.
- **Critical values**
  - If the CD4 count is low (below 200cells/ $\mu$ l for adult and below 450 cells/  $\mu$ l for children) the result will be regarded as critical and communicate with clinician

#### ***4.5.15 Limitations of the procedure and sources of error***

- Use the cartridge only with the BD FACS Presto instrument.
- The use of expired cartilage may result into false results
- Improper filling of the test device may not give the proper results

#### ***4.5.16 Performance Characteristics***

Refer to Method verification report

#### ***4.5.17 Supporting Documents***

Quality Manual, Sample Collection Manual, Safety Manual.

#### ***4.5.18 References***

Becton Dickinson BD FACS presto Operating Manual

## **4.6 PROCEDURE FOR DETERMINATION OF CLOTTING TIME**

### **4.6.1 Purpose**

The purpose of this standard operating procedure (SOP) is to provide guidelines to be followed for performing clotting time

### **4.6.2 Scope**

This procedure is to be performed at point of care or any health facility to detect the clotting time

### **4.6.3 Responsibility**

The Section heads are responsible section is responsible for ensuring the effective implementation and maintenance of this procedure. Qualified, competent and registered Medical Laboratory practitioners are responsible for implementing this test procedure.

### **4.6.4 Principle**

The presence of activator augments the contact activation phase of coagulation, which stimulates the intrinsic coagulation pathway. Clotting time can be performed manually, whereby the operator measures the time interval from when blood is injected into the test tube to when clot is seen along the sides of the tube.

### **4.6.5 Sample Requirements**

Whole blood

### **4.6.6 Equipment**

Stop watch, water bath and thermometer

### **4.6.7 Materials**

Disposable gloves, Laboratory coat, 70% alcohol, Masks, and Sterile lancets

### **4.6.8 Storage and Stability**

Not applicable

### **4.6.9 Safety**

- Adhere to safety precautions as stated in the facility Safety manual
- All personal protective equipment (PPE) must be worn when performing this procedure.
- All samples must be regarded as potentially infectious.
- Refer to National infection prevention and control Guidelines for health waste management and safety practice.

### **4.6.10 Calibration**

- Perform equipment calibration of the Stop watch, water bath and thermometer as per auxiliary equipment calibration schedule



#### **4.6.11 Quality Control**

Not Applicable

#### **4.6.12 Procedural Steps**

- Two methods can estimate clotting time:
  - ❑ **Capillary method of bleeding time.**
    - i. Prick the finger with the lancet.
    - ii. Hold the capillary over the blood, and the capillary will fill automatically.
    - iii. Now, after regular intervals, break the capillary.
    - iv. When a clot starts forming, that is the endpoint and clotting time.
  - ❑ **Test tube method of clotting time.**
    - i. Perform this test at 37 ° C.
    - ii. Take 4 ml of blood for the tube method and start the time.
    - iii. Note the time when there is the first appearance of the clot formation.
    - iv. This test can be done in multiple tubes to be more accurate.

#### **4.6.13 Biological Reference Interval**

Not Applicable

#### **4.6.14 Interpretation and Reporting of Results**

- i. The expected range is 4 to 10 minutes.
- ii. The glass tube method clotting time is 5 to 15 minutes.
- iii. Results are given in amount of minutes takes for bleeding time to stop

#### **4.6.15 Limitation of the Procedure and Sources of Error**

- i. This test is only prolonged in severe deficiency.
- ii. Normal clotting time is despite prolonged bleeding time seen in thrombocytopenia.
- iii. This may be normal in patients taking anticoagulant therapy.
- iv. This is usually normal when the intrinsic and common pathways are present in an amount not exceeding 1% of the normal plasma level.

#### **4.6.16 Performance Characteristics**

Refer the method verification report of the procedure.

#### **4.6.17 Supporting Documents**

Sample collection manual

#### **4.6.18 References**

A manual of laboratory diagnostic tests. Edition 7, Lipipicontt William and Wilkins, by Frances Talaska Fishbach, RN, BSN, MS, and MarshallaBrnet 11, RN, BSN, MS, Ph.D.

## **4.7 PROCEDURE FOR DETERMINATION OF THE BLEEDING TIME**

### **4.7.1 Purpose**

The purpose of this procedure is to provide instructions for investigation of bleeding time.

### **4.7.2 Scope**

This procedure is used in Haematology section when performing bleeding time

### **4.7.3 Responsibility**

Qualified, trained and competent health laboratory practitioners are responsible for implementing this test procedure.

The Head Haematology is responsible for ensuring the effective implementation and maintenance of this procedure.

### **4.7.4 Principle**

Bleeding time is a medical test done to assess platelet function of a patient. It involves cutting the underside of the subject's forearm, in an area where there is no hair or visible veins. The cut is of a standardized width and depth, and is done quickly by an automatic device. A blood pressure cuff is used above the wound, to maintain venous pressure at a special value. The time it takes for bleeding to stop (i.e. the time it takes for a platelet plug to form) is measured. Cessation of bleeding can be determined by blotting away the blood every several seconds until the site looks 'glassy'.

### **4.7.5 Sample Requirements**

Plasma/whole blood, Serum (2-5ml)

### **4.7.6 Equipment**

Timer, Thermometer, Light Microscope, Sphygmomanometer

### **4.7.7 Materials**

Marker pen, Examination Gloves, Filter paper, 70% alcohol swabs and Sterile lancets

### **4.7.8 Storage and Stability**

Not Applicable

### **4.7.9 Safety**

- Adhere to safety precautions as stated in the Safety manual/IPC guideline
- All personal protective equipment (PPE) must be worn when performing this procedure.
- All samples must be regarded as potentially infectious.

### **4.7.10 Calibration**

Perform calibration of equipment (Timer and Thermometer) as per calibration schedule

### **4.7.11 Quality Control**

Not Applicable

#### **4.7.12 Procedural Steps**

- i. Apply the blood pressure cuff to the arm just above the elbow.
- ii. Inflate the device to 40 mm of mercury and maintain at this level.
- iii. Clean the anterior surface of the fore arm with 70% alcohol swabs.
- iv. Make two clean punctures about 2 mm long and 2 mm deep being careful to avoid underlying veins.
- v. Blot the blood with the filter paper every 15 seconds but be careful and make sure you only touch the top of the drop.
- vi. start the stop watch as the first drop of the blood appears, immediately when the blood ceases stop the timer and record the time.
- vii. Calculate the average of the 2 punctures and record bleeding time.
- viii. **If** it's a prolonged bleeding time **then** perform Prothrombin Time (PT), Activated Partial Thromboplastin Time (APTT) and platelets count.

#### **4.7.13 Biological Reference Interval**

Not Applicable

#### **4.7.14 Interpretation and Reporting of Results**

**Interpretation** of results

- i. Interpret results in terms of minutes taken for bleeding to stop.
- ii. Normal ranges are around 1½ - 5 minutes.

#### **Reporting of results**

Report results as: *Bleeding time (in minutes)*

**Critical value:** Findings *greater than 10 minutes*.

#### **4.7.15 Limitation of the Procedure and Sources of Error**

Anything that alters platelet function can interfere with the bleeding time. Some examples include aspirin, thrombocytopenia, and uremia

#### **4.7.16 Performance Characteristics**

Not Applicable

#### **4.7.17 Supporting Document**

Sample collection manual

#### **4.7.18 References**

## **4.8 PROCEDURE FOR FULL BLOOD COUNT BY USING URIT BH – 40P HAEMATOLOGY ANALYSER.**

### **4.8.1 Purpose**

This procedure provides instruction on how to operate urit BH-40P haematology analyser in determining full blood count

### **4.8.2 Scope**

This procedure applies in the Haematology section when performing FBC (Full blood count) analysis using URIT BH - 40P Haematology Analyser.

### **4.8.3 Responsibility**

Qualified, trained and competent health laboratory practitioners are responsible for implementing this procedure. The Head Haematology is responsible for ensuring the effective implementation and maintenance of this procedure.

### **4.8.4 Principle**

The URIT BH – 40P Automated Haematology Analyser is a multi-parameter, it can display 21 parameters and 3 histograms. Analyser adopts electrical impedance method for WBC, RBC and PLT test and colorimetric method for HGB test. The electrical impedance method is based on non-conductivity of blood cells. When the blood cells in diluents pass through the ruby aperture, resistance will change, based on that we can get the counting and volume of blood cells. The colorimetric methods to measure and calculate HGB. Add lyse into the diluents sample, and then RBC will be dissolve and release haemoglobin. Then the haemoglobin combines with lyse to form cyanohemoglobin. Measure the transmission light intensity of this compound in a sample cup through the monochromatic light of 540 nm wavelength and then compare it with the result in blank state to get the haemoglobin concentration (blank state refers to the state that only has diluents in sample cup).

### **4.8.5 Sample Requirements**

Whole blood sample in EDTA-K<sub>2</sub>H<sub>2</sub>O tube.

### **4.8.6 Equipment**

- URIT BH-40 Automated Haematology Analyser
- Perform start up, maintenance, troubleshooting and shut down the URIT BH-40 Automated Haematology analyser as per manufacturer's instrument instructions

### **4.8.7 Materials**

Diluent, Lyse, Probe detergent, Set of Controls kit, Marker pen, Examination Gloves  
Capillary tube, Plane test tube, Thermal paper, and Gloves

### **4.8.8 Storage and Stability**

- Keep the Set of Controls at 2°C – 8°C
- Never use reagent and control beyond its expiration date

- Blood sample be kept at temperature between 2°C- 8°C for 7 days.

#### **4.8.9 Safety**

- Adhere to safety precautions as stated in the Safety manual/IPC guideline
- All personal protective equipment (PPE) must be worn when performing this procedure.
- All samples must be regarded as potentially infections.

#### **4.8.10 Calibration**

- URIT calibrates the analyser in factory before shipment.
- Use the user URIT BH-40P to recalibrate the analyser when there is shifts or trends in some parameters

#### **4.8.11 Quality Control**

Run all quality controls; QC1 (Low), QC 2 (Normal) and QC 3 (High) before examination of patient samples

#### **4.8.12 Procedural Steps**

##### **Running Patient Samples**

##### **i. Pre- diluent peripheral blood mode**

- Present the empty sample tube under aspiration probe.
- At main menu screen, click “Drain”; the diluents will be dispensed into the tube.
- Remove the tube, add 20µl of the blood sample to the tube, and gently shake the tube to make them well mixed.
- After that present the well mixed sample under the aspiration probe; make sure the probe touches bottom slightly.
- Press RUN key on the front panel and remove the sample after hearing beep sound. The result will be available after analysis is performed.

##### **ii. Whole Blood Mode**

- Gently shake the tube to well mix the blood sample, then present the sample tube beneath the probe, make sure the probe touches tube bottom slightly.
- Press RUN key and remove the sample after hearing beep sound. The results will be available after analysis is performed.

##### **iii. Ant coagulated Peripheral Blood Mode**

- Gently shake the tube to well mix the blood sample, then present the sample tube beneath the probe, make sure the probe touches tube bottom slightly.
- Press RUN key and remove the sample after hearing beep sound. The results will be available after analysis is performed.

#### **4.8.13 Biological Reference Interval**

See annex 1.

#### **4.8.14 Interpretation and Reporting of Results**

##### **Interpretation of results**

- Normal: if the results are within acceptable range.
- Abnormal (pathological): if the results are out of acceptable range

##### **Reporting of results**

- Results are automatically printed from the URIT BH-40P and then review by section head.
- Critical value

WBC > 20 x10<sup>9</sup>/L, HGB <5g/dL, PLT < 50 or 1000 x10<sup>9</sup>/L

#### **4.8.15 Limitation of the Procedure and Sources of Error**

- The test will be affected by hemolysed blood and coagulated blood.
- Samples with extreme lipemic, chylomicrons or extremely high bilirubin concentrations might produce falsely elevated haemoglobin values.

#### **4.8.16 Performance Characteristics**

Refer to the method verification report of this procedure.

#### **4.8.17 Supporting Document**

Sample collection manual

#### **4.8.18 References**

URIT BH- 40P Operation manual

## **4.9 PROCEDURE FOR FULL BLOOD COUNT USING OF ABX PENTRA 80 HAEMATOLOGY ANALYSER.**

### **4.9.1 Purpose**

This procedure provides instructions for operation and maintenance of ABX Pentra 80 analyzer for Full blood picture

### **4.9.2 Scope**

This procedure applies to all Full Blood Count tests done on ABX Pentra 80 analyser in the haematology section

### **4.9.3 Responsibility**

Qualified, trained and competent health laboratory practitioners are responsible for implementing this test procedure.

The Head Haematology is responsible for ensuring the effective implementation and maintenance of this procedure.

### **4.9.4 Principle**

The ABX Pentra 80 is an automated haematology analyser used for counting and differentiating the cellular components in whole blood using electrical impedance, cytochemical staining, light scatter and spectrophotometer.

The principle behind cell counting is based on disruption of electric current as particles pass through an orifice. An electric current applies on both sides of this orifice. Cells do not conduct electric current, therefore their passage through the orifice leads to a change of the electric current established between both electrodes. These electric current differences are registered and increment a counter at every cell passage.

A chemical agent is used to separate erythrocyte and leukocyte populations, because of size overlapping and quantities discrepancies. This chemical agent contained in Lysis (ACTI-DIFF) pops the cytoplasmic membrane of the red cells. Erythrocyte population disappears leaving the leukocytes.

A haemoglobin preservative is added in lysing agent to measure haemoglobin scaled down in a 540nm photometric tank at the end of the counting. The haemoglobin measurement is made from the first dilution. The lysing agent has a powerful haemoglobin reducer (potassium cyanide) and then the haemoglobin measurement follows Drabkin method with a 540nm reading. The integration of luminous intensity transmitted is evaluated according to the BEER-LAMBERT formula. An enzymatic liquid (ABX CLEANER) ensures the system cleanliness between every analysis and prevents carryover between samples.

### **4.9.5 Sample Requirements**

2 to 4mls of whole blood collected in K3 EDTA tube

#### **4.9.6 Equipment**

ABX Pentra 80 Analyser and Perform start up, maintenance, troubleshooting and shut down the ABX Pentra 80 Haematology analyser as per manufacturer's instrument instruction.

#### **4.9.7 Materials**

ABX Pentra 80 analyser reagent pack, Laboratory coat, Biohazard waste container. 0.5% Sodium hypochlorite solution, Distilled water, Protective gloves, Methanol, A4 paper

#### **4.9.8 Storage and Stability**

Control kit is stable until expiry date and should be kept at 2°C – 8°C. Blood sample be kept at temperature between 2°C- 8°C for 7 days.

#### **4.9.9 Safety**

- Adhere to safety precautions as stated in the Safety manual/IPC guideline
- All personal protective equipment (PPE) must be worn when performing this procedure.
- All samples must be regarded as potentially infections.

#### **4.9.10 Calibration**

Calibrate the ABX Pentra 80 analyser under the following conditions:

- i. Change of software
- ii. Major component replacement

#### **4.9.11 Quality Control**

Run control QC materials (Low, Normal and High) before patient samples

#### **4.9.12 Procedural Steps**

- i. Click the STAT MODE key.
- ii. Then write the patient ID, Age, Gender.
- iii. Click the VALIDATE key.
- iv. Mix well the patient sample.
- v. Place the sample on the tube holder of analyser.
- vi. Press the door of analyser inside to run the sample.
- vii. The patient results will be printed automatically.

#### **4.9.13 Biological Reference Interval**

See annex 1.

#### **4.9.14 Interpretation And Reporting Of Results**

- Normal: if the results are within acceptable range.
- Abnormal (pathological): if the results are out of acceptable range
- Results are automatically printed from the ABX Pentra 80 and then review by section head.
- Communicate the Critical value with clinicians



Test	Critical Value
Haemoglobin	Less than 5 g/dl (50 g/L)
White Blood Count	Less than 2.0 or greater than 18.0 cells/mm <sup>3</sup>
Platelet Count	Less than 50,000/ mm <sup>3</sup> or greater than 800,000/mm <sup>3</sup>

#### **4.9.15 Limitation of the Procedure and Sources of Error**

- i. Sickled red blood cells may not be accurately recognised and may give erroneous results
- ii. Samples with cold agglutinins may falsely decrease the red cell count. The indices will indicate that the haemoglobin and haematocrit values do not agree. Thin film is recommended. These samples should be incubated for 30 minutes at 37 °C and reanalysed.
- iii. Platelet clumps and neonatal samples may interfere with Drabkins method of haemoglobin determination.
- iv. Samples with extreme lipaemia, chylomicrons or extremely high bilirubin concentrations might produce falsely elevated haemoglobin values.
- v. Samples with nucleated red blood cells may falsely elevate white cell count. Additionally, presence of nucleated red cells may interfere with white cell differential count. Samples from patients with elevated chylomicrons and those receiving total parenteral nutrition (TPN) including a high lipid concentration may falsely elevate the platelet count.
- vi. Aggregated platelets may falsely elevate the white blood cell count and percentage of lymphocytes.
- vii. The presence of immature white blood cells, including blasts, may affect the accuracy of the differential. The instrument will give an '<< I >>' or 'M' error code if the blasts are suspected. A thin film is recommended.
- viii. Clinical studies have shown that the Full Blood Count is not affected by presence of malaria parasites, Howell-Jolly bodies, cryogloblins and red cell fragments.

#### **4.9.16 Performance Characteristics**

Refer to the method verification report of this procedure.

#### **4.9.17 Supporting Document**

Sample collection manual

#### **4.9.18 References**

ABX PENTRA 80 operator's manual

## 4.10 PROCEDURE FOR FULL BLOOD COUNT USING SINNOWA HB - 7021

### 4.10.1 Purpose

This procedure provides instructions for operation and maintenance of **SINNOWA HB – 7021 Hematology Analyser**.

### 4.10.2 Scope

This procedure applies to all Full Blood Count tests done on SINNOWA HB – 7021 analyser in the haematology section

### 4.10.3 Responsibility

Qualified, trained and competent health laboratory practitioners are responsible for implementing this test procedure.

The Haematology section head is responsible for ensuring the effective implementation and maintenance of this procedure.

### 4.10.4 Principle

The instrument adopts the method of impedance to measure and count cells. The conductivity liquid (mainly diluents) provides constant current source to the electrode thus they circuit can form a steady impedance circulation. When cells pass through the aperture, the conductive liquid is replaced by cells. Change of circuit resistance produces electrical pulse. The amplitude varies when the cells of different size pass through the aperture. Consequently the number and volume of cells pass through the aperture can be calculated based on the amplitude.

### 4.10.5 Sample Requirements

2 to 4mls of whole blood collected in K3 EDTA tube

### 4.10.6 Equipment

- SINNOWA HB – 7021 Haematology Analyzer, Refrigerator
- Perform start up, maintenance, troubleshooting and shut down the SINNOWA HB – 7021 Haematology analyser as per manufacturer's instrument instruction

### 4.10.7 Materials

Reagents	consumables
SINNOWA Diluent Reagent, SINNOWA Lyse Reagent, SINNOWA Detergent, SINNOWA Probe Detergent,	Laboratory coat, Biohazard waste container. 0.5% Sodium hypochlorite solution, Distilled water, Protective gloves, Methanol, Printing paper

### 4.10.8 Storage and Stability

- Control kit is stable until expiry date and should be kept at 2°C – 8°C
- Blood sample be kept at temperature between 2°C- 8°C for 7 days.
- Store reagents as per manufacturer instructions

### 4.10.9 Safety

- Adhere to safety precautions as stated in the Safety manual/IPC guideline
- All personal protective equipment (PPE) must be worn when performing this procedure.
- All samples must be regarded as potentially infectious.

#### **4.10.10 Calibration**

The SINNOWA HB – 7021 Hematology Analyser System requires commercial calibrator material or assayed whole blood for calibration.

Calibrate the SINNOWA HB – 7021 Hematology Analyser under the following conditions:

- Change of software
- Major component replacement

#### **4.10.11 Quality Control**

- Run the three levels of control LOW, NORMAL and HIGH” for “SINNOWA HB – 7021 Hematology Analyzer to ensure quality of results
- Perform Quality Control:-
  - Before analyzing the samples
  - After replacement of the reagents
  - After maintenance component replacement, or a field service action
  - If there is any doubt in accuracy of the test results
  - After a reagent lot number change
  - After a software change
  - Following calibration
  - According to your laboratory’s quality control program
  - According to manufacturer requirements

#### **4.10.12 Procedural Steps**

- Turn on the power on rear panel and indicator shows red light
- The instrument initializes test program
- Diluents, lyses and detergent will be sucked and tubing system cleaned
- If initialization is finished the display shows all parameters WBC,RBC and PLT
- Shift to select ID and then press OK
- Select the test selection from the drop down menu
- Gently mix the sample
- Open the sample tube and place it under the Open Mode Probe
- Raise the tube until the end of the probe is deeply immersed in the sample.  
Press the Touch Plate to activate aspiration
- Remove the tube when the beep sounds and replace the cap.
- When the cycle is finished, the results post to the Data log and are displayed in the Run View
- Print the results

#### **4.10.13 Biological Reference Interval**

See annex 1.

#### **4.10.14 Interpretation and Reporting of Results**

- Normal: if the results are within acceptable range.
- Abnormal (pathological): if the results are out of acceptable range
- Results are automatically printed from the SINNOWA HB – 7021 and then review by section head.
- Communicate the Critical value with clinicians

<b>Test</b>	<b>Critical Value</b>
<b>Haemoglobin</b>	Less than 5 g/dl (50 g/L)
<b>White Blood Count</b>	Less than 2.0 or greater than 18.0 cells/mm <sup>3</sup>
<b>Platelet Count</b>	Less than 50,000/ mm <sup>3</sup> or greater than 800,000/mm <sup>3</sup>

#### **4.10.15 Limitation of the Procedure and Sources of Error**

- Keep reagent away from direct sunlight and protect them from evaporation.
- Use reagent container cap attached to each inlet tube, the cap will minimize evaporation and contamination.
- Never use reagent, control and calibrators beyond their expiration date.

#### **4.10.16 Performance Characteristics**

Refer to the method verification report of this procedure.

#### **4.10.17 Supporting Document**

Sample collection manual

#### **4.10.18 References**

- SINNOWA HB – 7021 Hematology Analyser user manual.

## **4.11 PROCEDURE FOR FULL BLOOD COUNT USING BHA 3000 HAEMATOLOGY ANALYSER**

### **4.11.1 Purpose**

This procedure provides instructions for operation and maintenance of BHA 3000 Haematology Analyser.

### **4.11.2 Scope**

This procedure applies in haematology section for performing Full Blood Count tests done on BHA 3000 analyser

### **4.11.3 Responsibility**

Qualified, trained and competent health laboratory practitioners are responsible for implementing this test procedure. The Haematology section head is responsible for ensuring the effective implementation and maintenance of this procedure.

### **4.11.4 Principle**

BHA -3000 Automatic Hematology Analyser provides a 3 part differential blood count uses an electrical impedance to count red blood cells, platelets and volume distributions, and uses calorimetry to measure the haemoglobin and relevant parameters will be enumerated.

This system uses electrical impedance method to count red blood cells, platelets and white blood cells. When the absorbed quantitative sample is diluted by a quantitative conductive solution, it is sent to the detection unit of the instrument. The detection unit has a detection aperture, with a pair of positive and negative electrodes on both sides of the aperture, which is connected with a constant current power supply. Due to the bad conductor characteristic of these cells, when the cells in the diluted sample pass through the detection aperture under a constant negative pressure, the DC resistance between the electrodes will change, thus forming a pulse change at both ends of the electrode in portions to the size of the cell volume. When cells continuously pass through the aperture, a series of electrical pulses are generated at both ends of the electrodes. The number of pulse is equal to the number of cells passing through the aperture. And the pulse amplitude is proportion to the cell volume. Amplify the collected electrical pulses, and calculates the number of electric pulse in the red blood/platelets channel and WBC channel. The pulses are then classified according to different channel voltage threshold, hence determines the cell volume distribution

### **4.11.5 Sample Requirements**

2 to 4mls of whole blood collected in K3 EDTA tube

### **4.11.6 Equipment**

BHA 3000 Haematology Analyzer, Refrigerator

#### **4.11.7 Materials**

DIL-3 Diluent and HR-1 Lyse, Controls (Normal level (N), Low- level (L) and High-level (H) Laboratory coat, Biohazard waste container. 0.5% Sodium hypochlorite solution, Distilled water, Protective gloves, Printing paper

#### **4.11.8 Storage and Stability**

- Control kit is stable until expiry date and should be kept at 2°C – 8°C
- Blood sample be kept at temperature between 2°C- 8°C for 7 days.
- Store reagents as per manufacturer instructions

#### **4.11.9 Safety**

- i. Adhere to safety precautions as stated in the Safety manual/IPC guideline
- ii. All personal protective equipment (PPE) must be worn when performing this procedure.
- iii. All samples must be regarded as potentially infections.

#### **4.11.10 Calibration**

Calibrate the BHA 3000 Haematology Analyzer Analyser under the following conditions:

- i. Change of software
- ii. Major component replacement

#### **4.11.11 Quality Control**

Run the three levels of control LOW, NORMAL and HIGH” for BHA 3000 Haematology Analyzer to ensure quality of results

Perform Quality Control:-

- i. Before analyzing the samples
- ii. After replacement of the reagents
- iii. After maintenance component replacement, or a field service action
- iv. If there is any doubt in accuracy of the test results
- v. After a reagent lot number change
- vi. After a software change
- vii. Following calibration
- viii. According to your laboratory’s quality control program
- ix. According to manufacturer requirements

#### **4.11.12 Procedural Steps**

- i. Turn on the power on rear panel and indicator shows red light
- ii. The instrument initializes test program
- iii. Diluents, lyses and detergent will be sucked and tubing system cleaned
- iv. If initialization is finished the display shows all parameters WBC,RBC and PLT
- v. Shift to select ID and then press OK
- vi. Select the test selection from the drop down menu
- vii. Gently mix the sample
- viii. Open the sample tube and place it under the Open Mode Probe

- ix. Raise the tube until the end of the probe is deeply immersed in the sample.  
Press the press Plate to activate aspiration
- x. Remove the tube when the beep sounds and replace the cap.
- xi. When the cycle is finished, the results post to the Data log and are displayed in the Run View
- xii. Print the results

**4.11.13 Biological Reference Interval**

See annex 1.

**4.11.14 Interpretation and Reporting of Results**

- Normal: if the results are within acceptable range.
- Abnormal (pathological): if the results are out of acceptable range
- Communicate the following Critical value with clinicians

Test	Critical Value
Haemoglobin	Less than 5 g/dl (50 g/L)
White Blood Count	Less than 2.0 or greater than 18.0 cells/mm <sup>3</sup>
Platelet Count	Less than 50,000/ mm <sup>3</sup> or greater than 800,000/mm <sup>3</sup>

**4.11.15 Limitation of the Procedure and Sources of Error**

- iv. Keep reagent away from direct sunlight and protect them from evaporation.
- v. Use reagent container cap attached to each inlet tube, the cap will minimize evaporation and contamination.
- vi. Never use reagent, control and calibrators beyond their expiration date.

**4.11.16 Performance Characteristics**

Refer to the method verification report of this procedure.

**4.11.17 Supporting Document**

Sample collection manual

**4.11.18 References**

BHA 3000 Haematology Analyser user manual.

**District Level**

## **4.12 PROCEDURE FOR PERFORMING PERIPHERAL BLOOD SMEAR**

### **4.12.1 Purpose**

The procedure provides instructions on how to examine thin peripheral blood smear.

### **4.12.2 Scope**

This procedure applies to all laboratory practitioners in investigation of blood cell abnormalities.

### **4.12.3 Responsibility**

Qualified and competent Health Laboratory Practitioners are responsible for implementing this procedure. Section heads are responsible for ensuring the effective implementation and maintenance of this procedure.

### **4.12.4 Principle**

A stained smear is examined in order to determine the percentage of each type of leucocytes present, and assess the erythrocyte and platelet morphology. Increased in any of the normal leucocytes types or the presence of immature leucocytes or erythrocytes in peripheral blood are important diagnostically in a wide variety of inflammatory disorders and leukemia. Erythrocyte abnormalities are clinically important in various anemias. Platelet size irregularities are suggestive of particular thrombocyte disorders.

### **4.12.5 Sample Requirements**

Freshly collected venous blood and coagulated with EDTA

### **4.12.6 Equipment**

Manual counter, Slides, Cover slips/spreader, timer and Microscope

### **4.12.7 Materials**

#### **Reagent**

Giemsa stain, Immersion oil, Buffered water, Methanol

### **4.12.8 Storage and Stability**

Venous blood (EDTA) must be stored at 2-8°C refrigerators for 7 days

### **4.12.9 Safety**

Always handle sample with care, as they might be infectious. Consult local environmental authorities for proper disposal. Always wear protective gloves when handling sample.

### **4.12.10 Calibration**

Done annually by engineer

### **4.12.11 Quality Control**

Whole blood smear is prepared and stained by using giemsa stain to see all features of the cell.

### **4.12.12 Procedural Steps**



- i. Make a smear and air dry it.
- ii. Place the smear on a staining rack. Flood it with ethanol for 2 seconds and air dry it, this is the time required for fixation (ethanol acts as a fixative).
- iii. Place the smear on a staining rack; flood it with 10% giemsa stain
- iv. Leave for 10 minutes
- v. Add twice the amount of buffered water, pH 7 from a plastic wash bottle.
- vi. Wash the stain with buffered water till the smear has a pinkish tinge.
- vii. Wipe the back of the smear and stand upright to dry.
- viii. Observe at 10x objective to get a film, and then change to 100x objective lenses
- ix. Report the findings

#### **4.12.13      *Biological Reference Intervals***

Not applicable

#### **4.12.14      *Interpretation and Reporting of Results***

Interpretation of results should be made along with patient clinical features. Further investigations might be required to confirm the suspected abnormalities.

##### ***Reporting of Results***

Report the morphology, size, shape and number of cells (RBC, WBC, platelets)

#### **4.12.15      *Limitation of the Procedure and Sources of Errors***

- Delayed fixing of blood smears causes distortion of cellular morphology. Dried plasma stains the background of the smear a pale blue.
- The staining rack should be leveled.
- Do not let the stain solution dry over the smear.

#### **4.12.16      *Performance Characteristics***

Not Applicable

#### **4.12.17      *Supporting Documents***

Result Management procedure, Safety manual and Sample collection manual

#### **4.12.18      *References***

Cheesbrough, M (2000). Medical Laboratory Manual for Tropical Countries (Vol, I & Vol II). Butterworth-Heinemann, London

## **4.13 PROCEDURE FOR PERFORMING FULL BLOOD COUNT BY USING MS4 HAEMATOLOGY ANALYSER**

### **4.13.1 Purpose**

This procedure provides instructions for operation and maintenance of MS4 analyser for Full blood count

### **4.13.2 Scope**

This procedure applies to all Full blood count tests done on MS4 analyser in the Laboratory hematology section

### **4.13.3 Responsibility**

Qualified and trained Health Laboratory Practitioners are responsible for implementing this test procedure. Section head is responsible for ensuring the effective implementation and maintenance of this procedure.

### **4.13.4 Principle**

The MS4-S is an automated haematology analyser used for counting and differentiating the cellular components in whole blood using electrical impedence, cytochemical staining, light scatter and spectrophotometer.

The principle behind cell counting is based on disruption of electric current as particles pass through an orifice. An electric current applies on both sides of this orifice. Cells do not conduct electric current, therefore their passage through the orifice leads to a change of the electric current established between both electrodes. This electric current difference is registered and increment a counter at every cell passage.

A chemical agent is used to separate erythrocyte and leukocyte populations, because of size overlapping and quantities discrepancies. This chemical agent contained in Lysis (ACTI-DIFF) pops the cytoplasmic membrane of the red cells. Erythrocyte population disappears leaving the leukocytes. A Haemoglobin preservative is added in lysing agent to measure Haemoglobin scaled down in a 540nm photometric tank at the end of the counting. The Haemoglobin measurement is made from the first dilution. The lysing agent has a powerful Haemoglobin reducer (potassium cyanide) and then the Haemoglobin measurement follows Drabkin method with a 540nm reading. The integration of luminous intensity transmitted is evaluated according to the BEER-LAMBERT formula.

An enzymatic liquid (TRANSFLUX) ensures the system cleanliness between every analysis and prevents carryover between samples.

### **4.13.5 Sample Requirements**

2 to 4mls of whole blood collected in K3 EDTA purple top color tube

### **4.13.6 Equipment**

MS4-S Hematology Analyser, and roller mixer

#### **4.13.7 Materials**

MS4-S analyser reagent pack, Laboratory coat, Biohazard waste container, 5-6% Sodium hypochlorite, Distilled water, Protective gloves and Methanol

#### **4.13.8 Storage and Stability**

Blood is stable for about 4 hours at room temperature or 24hours at 2- 6oC

#### **4.13.9 Safety**

- i. Treat all samples as potentially infectious.
- ii. Keep hands away from the sample carrier when the analysis begins
- iii. Some components inside the MS4s have sharp edges or angular corners, therefore operate with caution to avoid cuts to the hands
- iv. When performing maintenance procedure, take similar precautions as you would take when handling patient samples

#### **4.13.10 Calibration**

All auxiliary equipment should be calibrated annually

#### **4.13.11 Quality Control**

Use commercially quality control or in house prepared quality control samples

#### **• Running of quality control**

- i. Take the QC material from the refrigerator and let them stay at room temperature for 15 minutes.
- ii. After 15 minutes' mix well the controls one by one by inverting the tube gently at least (x7) seven times without creating bubbles.
- iii. Press ANALYSIS key (Tube like symbol) then DOWN arrow (↓).
- iv. Select Quality CT (to run controls) then use RIGHT arrow (→) to select control levels.
- v. Select LOW if you start with low control up to High control using UP and DOWN arrows on key board or on machine. (↑) or (↓)
- vi. Place the control tube on the tube holder
- vii. Press ENTER key on keyboard or ( → ) on the machine to validate
- viii. Repeat the procedure to the Normal and High controls
- ix. The QC results will be printed automatically
- x. Plot the results of the QC on the Levy-Jennings chart and verify that the QC has passed before running patients' samples.

#### **4.13.12 Procedural Steps**

#### **• Running of Patient Samples**

- i. Press Analysis key in the machine
- ii. Press RIGHT arrow (→)
- iii. Select the gender female or male by using UP and DOWN arrows (↑) or (↓)
- iv. Press the ENTER key (using key board) or ( → ) on the machine to validate
- v. Write the name of the patient (Full Name)
- vi. Mix well the sample

- vii. Place the sample on the tube holder of the machine.
- viii. Press ENTER on keyboard or (←→) on the machine to start running the sample.
- ix. The patient results will be printed automatically.

#### **4.13.13 Biological Reference Intervals**

See annex 1.

**Critical value/results** should be recorded and immediately communicated to the requesting clinician.

#### **4.13.14 Interpretation and Reporting of Results**

Results are reported and communicated through the appropriate locally established procedure

#### **4.13.15 Limitation of the Procedure and Sources of Errors**

- i. Exposing reagents to direct sunlight may cause them to deteriorate
- ii. Sickled red blood cells may not be accurately recognised
- iii. Samples with cold agglutinins may falsely decrease the red cell count.
- iv. Platelet clumps and neonatal samples.
- v. Samples with extreme lipaemia, chylomicrons or extremely high bilirubin concentrations might produce falsely elevated Haemoglobin values.
- vi. Samples with nucleated red blood cells may falsely elevate white cell count.
- vii. Samples from patients with elevated chylomicrons and those receiving total parenteral nutrition (TPN) including a high lipid concentration may falsely elevate the platelet count.
- viii. Circulating micro megakaryocytes may be counted as white cells
- ix. Aggregated platelets may falsely elevate the white blood cell count and percentage of lymphocytes.

#### **4.13.16 Performance Characteristics**

Method verification should be carried out and its report will be referred to fulfil this requirement.

#### **4.13.17 Supporting Documents**

Laboratory quality policy manual, Laboratory safety policy manual and Laboratory sample collection manual

#### **4.13.18 References**

MS4S operator's manual, 2013-07

## **4.14 PROCEDURE FOR FULL BLOOD COUNT BY USING DYMIND DH-36 ANALYSER**

### **4.14.1 Purpose**

This procedure provides instructions for determination of full blood picture using the Dymind DH-36 Analyser.

### **4.14.2 Scope**

This procedure applies to all competent laboratory staffs who operate the DYMIND DH 36 Automated Haematology Analyser

### **4.14.3 Responsibility**

The Head of haematology is responsible of ensuring that this procedure is effectively implemented and maintained

### **4.14.4 Principle**

**Electrical impedance**, for determination of total WBC/basophil, RBC, Platelets. Changes electric resistance produced by a blood cell particle suspend in a conductive diluent as passes through aperture of known dimension. This change produce measurable electric pulse, number of pulse is equal to number of blood cell particle and amplitude of each pulse proportional to volume of that particle. Pulse generated being above the WBC/bas, RBC, PLT lower threshold value, it's counted as WBC/BAS, RBC or PLT.

**Colorimetric**, RBC is lysed, lyse E-1 converts haemoglobin to Hb complex that is measurable at 525nm absorbance.

**Laser flow cytometry**, used to obtain WBC differential count, blood cells suspension is injected into a flow chamber exposed to laser beam. The intensity of scattered light reflects blood cell size and intracellular density. The Optical detector receives this scattered light and converts it into electric pulses, analyser presents Lym%, Neu% and mixed%.

### **4.14.5 Sample Requirements**

Venous whole blood (VWB), running single sample per time in EDTA tube.

Capillary whole blood (CWB), running single sample per time in centrifuge tube.

Predilute (PD), running single sample per time in cryo-tube. Diluted 180µl.

### **4.14.6 Equipment**

Dymind DH-76 analyser, Sample mixer/roller

### **4.14.7 Materials**

DIL-E diluent, CLE-P cleanser, LYA-E-1 lysing RBC, Printing papers, Cartilage

### **4.14.8 Storage and Stability**

Store and use reagents as specific instructions for reagent use.

#### **4.14.9 Safety**

Samples, controls, calibrators, reagents wastes are potentially biohazards, wear personal protective equipment's.

Adhere to safety precautions as stated in the Safety manual

All personal protective equipment (PPE) must be worn when performing this procedure.

All samples must be regarded as potentially infections.

#### **4.14.10 Calibration**

Calibration is done by the engineer during annual maintenance or as needed

#### **4.14.11 Quality Control**

Run low, normal and high controls daily as available. Run comparability checks with other instruments in use. In addition, run controls;

- i. When reagent lot number changes.
- ii. Following instrument calibration.
- iii. When instrument shuts down (i.e., power outages).

#### **4.14.12 Procedure Steps**

##### **Starting operation of the analyser;**

Turn on the power switch to start-up DH-36 and automatically launch its software.

Login software: enter correct username and password in login message box, system will initialize operations automatically (system self-test, fluidics check and cleaning, background check), this process takes 5 minutes.

##### **Equipment Shut Down**

Select shutdown on the screen

Present CLE-P Cleanser on sample probe and the analyser will be cleaned by cleaner solution.

Shut down the analyser by switching off the main switch at the back of the machine.

##### **Exiting Sleep Mode**

Press the touch plate (run button) and the analyser will exit sleep mode or double tap the analyser screen

##### **Running Samples**

- i. Click Sample Analysis on the screen.
- ii. Then select "MODE and ID".
- iii. Sub window will open then select mode to use and enter Sample ID.
- iv. Click OK.
- v. Pre-mix SAMPLE 8-10 times then present sample on sample probe.
- vi. Raise the tube so that the end of the probe is deeply immersed in the sample.
- vii. Press the touch plate (run button) to start the run cycle (aspiration).
- viii. Remove the sample tube after a beep sound is heard after aspiration.
- ix. Wait for the run cycle to be completed then results will display on the screen.

#### **4.14.13 Biological Reference interval**

See annex 1.

**4.14.14 Interpretation and Reporting of Results**

If the result is out of the normal range, an arrow will be displayed. The direction of the arrow will indicate if it is high or low. Results are reported through a print-out from the equipment.

**4.14.15 Limitations of the procedure and sources of error**

The equipment will not analyse clotted samples. Samples with minor clots will give false platelet results. Haemolysed samples are not suitable

**4.14.16 Performance Characteristics**

Refer to data for method verification report

**4.14.17 Supporting document**

Sample collection manual

**4.14.18 References**

- DH-36 Operator's Manual.
- Essential Laboratory Tests Standard Operating Procedures –AMREF-2008.

## **4.15 PROCEDURE FOR FULL BLOOD COUNT USING DYMIND DH 76 HAEMATOLOGY ANALYSER**

### **4.15.1 Purpose**

The purpose of this procedure is to provide instructions for performing Full Blood Count using DYMIND DH 76 haematology analyser.

### **4.15.2 Scope**

This procedure applies to all competent laboratory staffs who operate the DYMIND DH 76 Automated Haematology Analyser.

### **4.15.3 Responsible person**

The Qualified, competent and registered health laboratory practitioners are responsible to carry out this procedure.

Section heads are responsible for ensuring the effective implementation and competency assessment for this procedure

### **4.15.4 Principle**

DYMIND DH 76 use the electrical impedance method for determining the WBC/BAS, RBC and PLT data, calorimetric method for determining the HGB: Laser –based flow cytometry for determining the WBC data during each analysis cycle, the sample is aspirated, diluted and mixed before the determination of for each parameter is performed either by open – vial or autoloader sampling mode.

### **4.15.5 Sample Requirements**

2 to 4 mls of whole blood in K<sub>3</sub>EDTA anticoagulant (purple top tube)

### **4.15.6 Equipment**

Perform the procedure for start up, maintenance, troubleshooting and shut down the DYMIND DH 76 analyser as per manufacturer's instrument instructions

### **4.15.7 Materials**

Diluent DIL-A Diluent, Lyse LYA-2 Lyse, Lyse LYA-1 Lyse, Lyse LYA-3 Lyse, Medical cleanser, CLE-P cleanser, Gloves, Vacuum tubes, Printer, Autoloader rack

### **4.15.8 Storage and Stability**

- Store reagents, calibrators, and controls according to directions in the manufacturer's documentation (such as a package insert or label recommendation).
- All reagents should be protected from direct sunlight, extreme heat, and freezing during shipment and storage.
- Sample stability after collection of venous whole blood:
  - ✓ Samples run within eight hours of collection should be stored at Room Temperature.
  - ✓ Samples run more than eight hours after collection should be refrigerated (2°–8°C).



- Any refrigerator-stored samples should be brought to room temperature before mixing and processing.

#### **4.15.9 Safety**

- Adhere to safety precautions as stated in the Safety manual
- All personal protective equipment (PPE) must be worn when performing this procedure.
- All samples must be regarded as potentially infectious.
- Refer to National infection prevention and control Guidelines for health waste management and safety practice.
- All spills should be wiped thoroughly using 1% sodium hypochlorite solution.

#### **4.15.10 Calibration**

Refer to the DYMIND DH 76 instructions manual for use for description of calibration procedures. Calibrate the DYMIND DH 76 when

- ✓ When a major component has been replaced by service.
- ✓ After every SIX (6) month during service.
- ✓ When indicated by quality control data
- ✓ Run the internal quality control samples to verify the performance of the machine

#### **4.15.11 Quality Control**

Three levels of Haematology control must be assayed and evaluated at least once every 24 hours. Follow the DYMIND DH 76 instruction manual to run internal quality control samples

#### **4.15.12 Procedure Steps**

##### **Manual Mode**

- If the bar-code system scanner is not working, in-put the sample information in the work list interface.
- If the bar-code and scanner systems are working, scan the sample and the patient information will be automatically taken into the equipment from the eHMS.
- Click mode in the function button area in the main interface.
- Choose venous whole blood or capillary whole blood in the pop up dialog box as required.
- Choose the measurement mode CBC or CBC +DIFF and enter sample ID.
- Click OK.
- Remove the tube cap and place the well mixed sample under the probe, press aspirate key or click the start button on the interface.
- When you hear a beep sound, remove the sample tube the analyser will automatically run the sample

##### **Running Sample in Automated (AWB) Mode**

- Place the sample racks from the outer side of loading tray.

- ii. If the bar-code system scanner is not working, in-put the sample information for each sample on the rack in the work list interface.
- iii. Click mode in the function button.
- iv. Choose AWB in the pop up dialog box.
- v. Select measurement mode CBC or CBC +DIFF and enter Rack number.
- vi. Click OK.
- vii. Place racks loading tubes in ascending order on the level of the right tray of the auto-loader with barcode level facing analyser.
- viii. Click Start button or RUN to start sample analysis.
- ix. You can run urgent sample by using STAT function button. This is done manually.

#### **4.15.13      *Biological Reference interval***

See annex 1.

#### **4.15.14      *Interpretation and Reporting of Results***

Normal results are patient results which fall within the reference range for the particular test. Abnormal results are those that fall below or above the reference range. The test report labelled with H: High and L: Low shows the abnormality obtained from patient sample

#### **4.15.15      *Limitations of the procedure and sources of error***

- WBC: Fragile WBC, neutrophil aggregates, lytic-resistant RBC, NRBC, PLT clumps, cryofibrinogen, Cryoglobulin, paraproteins
- RBC: Elevated WBC count, increased numbers of giant PLT, auto agglutination, in vitro haemolysis
- HGB: Elevated WBC count, increased plasma substances (triglycerides, bilirubin, in vivo haemolysis), lytic-resistant RBC
- MCV: Elevated WBC count, hyperglycaemia, in vitro haemolysis, increased numbers of giant PLT
- PLT: WBC fragments, in vitro haemolysis, microcytic RBC, cryofibrinogen, Cryoglobulin, PLT clumping, increased numbers of giant PLT

#### **4.15.16      *Performance Characteristics***

Refer to the method verification report.

#### **4.15.17      *Supporting Documents***

Sample Collection Manual, Safety Manual, and Quality Manual.

#### **4.15.18      *References***

- DYMIND DH 76 Operator's manual

## **4.16 PROCEDURE FOR FULL BLOOD COUNT USING SYSMEX XS-500i**

### **4.16.1 Purpose**

This procedure provides instructions for determining Full Blood Count using Sysmex-XS-500i Haematology Analyser

### **4.16.2 Scope**

This procedure will be used for operating Sysmex XL 500 i in the laboratory

### **4.16.3 Responsible person**

The Qualified, competent and registered health laboratory practitioners are responsible to carry out this procedure.

Section heads are responsible for ensuring the effective implementation and competency assessment for this procedure

### **4.16.4 Principle**

The Sysmex machine is an automated haematology analyser used for counting and differentiating the cellular components in whole blood using electrical impedance, cytochemical staining and light scatter and spectrophotometry

### **4.16.5 Sample Requirements**

EDTA Ant coagulated venous blood (EDTA-2K, EDTA-3K OR EDTA-2Na.

EDTA ant coagulated blood should be processed within FOUR (4) HOURS of collection.

### **4.16.6 Equipment**

Perform the procedure for start up, maintenance, troubleshooting and shut down of the SYSMEX Xs-500i HAEMATOLOGY analyser as per manufacturer's instrument instructions

### **4.16.7 Materials**

Cell pack, Stromatolyser-4DL, Stromatolyser-4DS, Sulfolyser, Cell clean Printing papers

### **4.16.8 Storage and stability**

- Store the Control materials at 2-8<sup>0</sup>c before and after opening.
- Do not Use the instrument in places where ambient temperature range below 15<sup>0</sup>C and above 30<sup>0</sup>C
  - If the SAMPLE cannot be processed within 4 hours, store them to the refrigerator at temperature of refrigerated at 2 – 8<sup>0</sup>C

### **4.16.9 Safety**

- i. Decontaminate working surfaces twice daily, in the morning and afternoon
- ii. Adhere to safety precautions as stated in the Safety manual.
- iii. Wear the personal protective equipment (PPE) when performing this procedure.

- iv. Regard All samples as potentially infections.
- v. Refer to National infection prevention and control Guidelines for health waste management and safety practice.
- vi. Wiped all spills thoroughly using 1% sodium hypochlorite solution.
- vii. In principle, all parts and surfaces of this instrument must be regarded as potentially infectious, since this instrument analyses patient SAMPLE.
- viii. Use protective garments and gloves when operating, maintenance or servicing the unit and after work is completed, wash hands with disinfectant.
- ix. If inadvertently come in contact with potentially infectious materials or surface, immediately rinse skin thoroughly with water and follow the laboratory's prescribed cleaning and decontamination procedure.
- x. Control blood must be regarded as potentially infectious. Wear protective garments and gloves when performing quality control.
- xi. Never touch waste or parts having been in contact with waste, with your bare hands.
- xii. Cell clean is a strong alkaline detergent so avoid contact with skin, eye, or clothes because it may cause injury or damage, in case of contact, flash the area with water.
- xiii. Refer to the SYSMEX Xs-500i instructions for use for more safety information.

#### **4.16.10 Calibration**

Refer to the SYSMEX XS-500i instructions for use for description of calibration procedures. Calibrate the SYSMEX XS-500 when

- When a major component has been replaced by service.
- After every SIX (6) month during service.
- When indicated by quality control data
- Run the internal quality control samples to verify the performance of the machine

#### **4.16.11 Quality control**

Follow the Sysmex XS 500i instruction manual to process internal quality control samples.

- **Process internal quality control samples:**
  - ✓ Before analysing the samples
  - ✓ After replacement of the reagents
  - ✓ After maintenance
  - ✓ If there is any doubt in accuracy of the test results

#### **4.16.12 Procedure Steps**

- Press the MANUAL SAMPLE ICON to display various information pertaining to the patient.
- Enter patient detail and press OK

- Place the sample tube to the aspiration needle and press the START SWITCH
- Take the printout and check for any errors or discrepancies
- Enter the results via the computer using the laboratory information system

#### **4.16.13      *Biological Reference Intervals***

See annex 1.

#### **4.16.14      *Interpretation and Reporting of Results***

- Normal results are patient results which fall within the reference range for the particular test.
- Abnormal results are those that fall below or above the reference range.
- The test report labelled with H: High and L: Low shows the abnormality obtained from patient sample.

#### **4.16.15      *Limitations of the procedure and sources of errors***

1. Possible interference substances
2. If any of the following is present, the system may erroneously report a HIGH white blood cell count.
  - ✓ Possibility of PLT clumps
  - ✓ Lyse resistant erythrocytes
  - ✓ Erythrocyte aggregation (cold agglutinin)
  - ✓ Cryoprotein
  - ✓ Cryoglobulin
  - ✓ Fibrin
  - ✓ Giant platelets (platelets >1,000,000/μL)
3. RBC: If any of the following is present, the system may erroneously report a LOW red blood cell count.
  - ✓ Erythrocytes aggregation (cold agglutinin)
  - ✓ Micro erythrocytes
  - ✓ Possibility of fragmented RBC'S
4. If any of the following is present, the system may erroneously report a HIGH red blood cell count.
  - ✓ Giant platelets (platelets >1,000,000/ μl)
  - ✓ Leucocytosis (>100,000/ μl)
  - ✓ HGB: If any of the following is present, the system may erroneously report a HIGH haemoglobin concentration.
  - ✓ Leucocytosis (>100,000/ μl)
  - ✓ Lipemia
  - ✓ Abnormal protein
5. HCT: If any of the following is present, the system may erroneously report a LOW haematocrit value.
  - ✓ Erythrocytes aggregation (cold agglutinin)
  - ✓ Micro erythrocytes

- ✓ Possibility of fragmented RBC'S
  - ✓ If any of the following is present, the system may erroneously report a HIGH haematocrit value.
  - ✓ Leucocytosis (>100,000/  $\mu$ l)
  - ✓ Severe diabetes
  - ✓ Uraemia
  - ✓ Spherocytosis
6. PLT: If any of the following is present, the system may erroneously report a LOW platelets count.
- ✓ Possibility of PLT clumps
  - ✓ Pseudo thrombocytopenia
  - ✓ Giant platelets
7. If any of the following is present, the system may erroneously report a LOW platelets count.
- Micro erythrocytes
  - Possibility of fragmented RBC'S
  - Fragmented leucocytes
  - Cryoprotein
  - Cryoglobulin

#### **4.16.16 Performance Characteristics**

Method verification should be performed, the report will be referred to fulfil this requirement.

#### **4.16.17 Supporting documents**

Sample collection manual, Quality Manual and Safety Manual

#### **4.16.18 References**

Sysmex Instrument Manual version.

## **4.17 PROCEDURE FOR FULL BLOOD COUNT BY USING SYSMEX XN - 550 ANALYSER**

### **4.17.1 Purpose**

The purpose of this procedure is to provide instructions for operation and maintenance of SYSMEX XN-550 Auto Haematology Analyser.

### **4.17.2 Scope**

The procedure is used in Haematology section when performing Full Blood Count (FBP) by using Sysmex XN-550 Auto Haematology Analyser.

### **4.17.3 Responsible person**

The Qualified, competent and registered health laboratory practitioners are responsible to carry out this procedure.

Section heads are responsible for ensuring the effective implementation and competency assessment for this procedure

### **4.17.4 Principle**

The Sysmex XN-550 is multi-parameter quantitative automated haematology analysers for in vitro diagnostic use in determining whole blood diagnostic parameters. Examination of the numerical and/or morphological findings of the complete blood count by the physician are useful in the diagnosis of disease states such as anaemia, leukemia, allergic reactions, viral, bacterial, and parasitic infections. The devices perform haematology analyses based on the hydrodynamically focused impedance measurement, the flow cytometry method (using a semiconductor laser) and the SLS-haemoglobin method. The device counts and sizes red blood cells (RBC) and platelets (PLT) using hydrodynamic impedance counting (sheath flow DC method). At the same time the haematocrit (HCT) is measured as a ratio of the total RBC volume to whole blood via the RBC pulse height detection method. Cytometry is used to analyse physiological and chemical characteristics of cells and other biological particles. Flow cytometry is a method used to analyse those cells and particles as they pass through extremely small flow cells. The Data Innovations Instrument Manager (DI) is a Data Innovations computer program which is used to manage data coming from the XN-550 analysers and sends that data to the Laboratory Information System (LIS). Sets of WBC, RBC, and PLT rules determine how positive parameter flags are handled by the instrument and/or operator and which samples are auto-validated by the DI. Manual differentials and RBC/Platelet morphology is entered via the DI. Pending Orders are checked via the Outstanding List in EPIC.

### **4.17.5 Sample Requirements**

Anticoagulated whole blood

#### **4.17.6 Equipment**

Perform the procedure for start up, maintenance, troubleshooting and shut down the SYSMEX XN-550 analyser as per manufacturer's instrument instructions

#### **4.17.7 Materials**

Cell pack dcl, Sulfolyser, Lysercell wdf, Fluorocell wdf Controls, Commercial controls; XN CHECKTM, Gloves, Vacuum collection tubes (K2EDTA), CELL CLEAN® AUTO and Autoloader rack

#### **4.17.8 Storage and Stability**

- Store reagents, calibrators, and controls according to directions in the manufacturer's documentation (such as a package insert or label recommendation).
- All reagents should be protected from direct sunlight, extreme heat, and freezing during shipment and storage. ..
- Sample stability after collection of venous whole blood:
  - ✓ Samples run within eight hours of collection should be stored at Room Temperature.
  - ✓ Samples run more than eight hours after collection should be refrigerated (2°–8°C).
- Any refrigerator-stored samples should be brought to room temperature before mixing and processing.

#### **4.17.9 Safety**

- i. Decontaminate working surfaces twice daily, in the morning and afternoon
- ii. Temperatures for the room and refrigerator are recorded twice daily, in the morning and afternoon.
- iii. Adhere to safety precautions as stated in the Safety manual
- iv. All personal protective equipment (PPE) must be worn when performing this procedure.
- v. All samples must be regarded as potentially infectious.
- vi. Refer to National infection prevention and control Guidelines for health waste management and safety practice.
- vii. Avoid any contact between hands and eyes and nose during SAMPLE collection and testing.
- viii. Do not use kit beyond the expiration date which appears on the package label or device in a damaged pouch.
- ix. The test device should be stored at 2 -30.0 C. And the test should be performed at room temperature.
- x. Do not reuse the test device.
- xi. All spills should be wiped thoroughly using 1% sodium hypochlorite solution.

#### **4.17.10 Calibration**

- Refer to the SYSMEX XN-550 instructions manual for use for description of calibration procedures.



- Calibrate the SYSMEX XN-550 when
  - ✓ When a major component has been replaced by service.
  - ✓ After every SIX (6) month during service.
  - ✓ When indicated by quality control data
- Run the internal quality control samples to verify the performance of the machine

#### **4.17.11 Quality Control**

- Run internal quality control samples daily before examining patient samples;
- Post calibration procedure to verify the newly stored calibration curve before running patient samples.
- When new reagent lot number is loaded.
- When there is a change in the system software.
- When a system maintenance/ component replacement procedure is performed

#### **4.17.12 Procedure Steps**

##### **System Analysis (sampler analysis)**

- i. Make sure the sampler cover (front) and sampler cover (manual unit) are closed.
- ii. Make sure the button on the right edge of the control menu is set as sampler. When the mode is set to manual, press the mode switch.
- iii. Make sure that either the left or right sampler adapter holder is in a state to be pulled out.
- iv. A sampler adapter holder can be pulled out when the sampler adapter status indicator LED is solid green or OFF.
- v. Pull out the sampler adapter holder that you want to use and Remove the sampler adapter.
- vi. Mix the sample and Place the sample tube in the sampler adapter.
- vii. Touch Sampler on the right edge of the control menu.
- viii. Touch an item to set the condition.
- ix. Touch [OK].
- x. Place the sampler adapter in the sampler adapter holder selected in the sampler settings box.
- xi. Push in the sampler adapter holder.
- xii. Press the sampler analysis start/stop switch.
- xiii. On-Board rules engine will determine repeat or reflex testing.
- xiv. Rack will run in reverse to perform repeat or reflex testing.
- xv. Remove the rack from the left sampler pool when analysis is completed and Make smear if indicated.

## Manual Analysis

- i. Check the status of the analyser. Confirm the analyser is ready.
- ii. Make sure the button on right side of control menu is Manual. When it's set to Sampler, touch [Mode] in the control menu.
- iii. Select the Change Analysis Mode button on the control menu and Select analysis mode [Whole blood] is selected when whole blood is being analysed
- iv. Select this to perform low WBC analysis on whole blood
- v. Select Manual Analysis button on the control menu 7) Input sample ID or use handheld barcode reader to scan sample ID.
- vi. Patient information – Touch input to enter patient ID.
- vii. Query to Host-Specify whether or not the host is queried for the analysis order.
- viii. Aspiration Sensor – Specify whether or not the aspiration sensor is used.
- ix. Cap Open – Select this checkbox to perform micro sample analysis (analysis with the sample tube cap open.)
- x. Raised Bottom Tube – Assure appropriate adaptor in use – See Instructions for Use Manual.
- xi. Open the Sampler cover (manual unit) and properly mix the SAMPLE and place in the tube holder.
- xii. If running microtainer, remove the cap using caution to avoid splattering.
- xiii. Press the start switch on the analyser. The tube holder will slide in and the sample will be aspirated.
- xiv. When the analysis is complete, the tube holder slides out.
- xv. Remove the sample, repeat steps for additional samples
- xvi. Review results in IPU to determine whether repeat or reflex testing is required.
- xvii. Rerun sample if required. Make smear if required Preparation before the operation
- xviii. Check and make sure the waste container is empty
- xix. Make sure there is sufficient reagents, reagents and waste tubing are properly connected and not bent
- xx. Make sure the power cord of the analyser is properly plugged into the power outlet.
- xxi. Check and make sure the computer and all its accessories are properly connected and enough printer papers are installed in the printer.
- xxii. Verify network / host connections are properly working

### **4.17.13      *Biological Reference interval***

See annex 1.

#### **4.17.14 Interpretation and Reporting of Results**

- Interpretation of results is based on the Biological reference range; normal results are patient results which fall within the reference range for the particular test.
- Abnormal results are those that fall below or above the reference range

#### **4.17.15 Limitations of the procedure and sources of error**

- i. Samples must be free of clots and fibrin strands.
- ii. Marked changes in plasma constituents (e.g., low sodium, extremely elevated glucose) may cause cells to swell or shrink. The blood to anticoagulant ratio is important.
- iii. Red cell fragments, microcytic RBCs or white cell cytoplasmic fragments may interfere with automated platelet counts.
- iv. Cold agglutinins produce spurious macrocytosis, elevated MCHs MCHCs, falsely decreased RBC counts and HCTs. Rare warm agglutinins produce the same spurious results as a cold agglutinin. Extremely elevated WBCs may cause turbidity and falsely increase the haemoglobin, in addition to RBC and HCT values.
- v. Severely haemolysed samples (in vitro) falsely decrease RBC and haematocrit. Recollect haemolysed samples.
- vi. Giant platelets and clumped platelets may falsely elevate the WBC count and falsely decrease the platelet count. Platelet clumping and/or "platelet satellitism" can occur in samples collected in EDTA. This may falsely elevate the WBC count and falsely decrease the platelet count. Send sample to La Crosse for analysis.
- vii. Abnormal paraproteins found in blood from patients with Multiple Myeloma can falsely increase the HGB. Send to La Crosse for analysis.
- viii. Severely icteric samples may falsely elevate the HGB value and related indices. Send to La Crosse for confirmation of results.
- ix. Rocking SAMPLE excessively, may affect the WBC differential.
- x. Megakaryocyte may falsely increase WBC counts on automated haematology analysers

#### **4.17.16 Performance Characteristics**

Refer to the method verification report of this procedure

#### **4.17.17 Supporting Documents**

Sample collection manual , safety manual and quality manual

#### **4.17.18 References**

Essential Laboratory Tests Standard Operating Procedures –AMREF-2008.  
SYSMEX XN-550 Auto Haematology Analyser Operator's manual

## **4.18 PROCEDURE FOR FULL BLOOD COUNT USING SYSMEX XN-1000/2000**

### **4.18.1 Purpose**

Procedure provides instructions for operating XN-1000 and XN-2000 machine for FBP.

### **4.18.2 Scope**

This procedure is to be used operate XN-1000 and XN-2000 machine for FBP in Haematology section

### **4.18.3 Responsible person**

The Qualified, competent and registered health laboratory practitioners are responsible to carry out this procedure. Section heads are responsible for ensuring the effective implementation and competency assessment for this procedure

### **4.18.4 Principle**

**Electrical impedance**, for determination of total WBC/basophil, RBC, Platelets. Changes electric resistance produced by a blood cell particle suspend in a conductive diluent as passes through aperture of known dimension. This change produces measurable electric pulse, number of pulses is equal to number of blood cell particle and amplitude of each pulse proportional to volume of that particle. Pulse generated being above the WBC/bas, RBC, PLT lower threshold value, it's counted as WBC/BAS, RBC or PLT.

**Colorimetric**, RBC is lysed, haemoglobin is converted to Haemoglobin complex that is measurable at 525nm absorbance.

**Laser flow cytometry**, used to obtain WBC differential count, blood cells suspension is injected into a flow chamber exposed to laser beam. The intensity of scattered light reflects blood cell size and intracellular density. The Optical detector receives this scattered light and converts it into electric pulses, analyser presents Lym%, mono%, Eos% and Neu%.

### **4.18.5 Sample Requirements**

2- 4ml Ant coagulated whole blood.

### **4.18.6 Equipment**

Perform the procedure for start up, maintenance, troubleshooting and shut down the XN-1000 and XN-2000 analyser as per manufacturer's instrument instructions

### **4.18.7 Materials**

Cell pack DCL, Sulfolyser, Lysercell WNR, Lysercell WDF, Fluorocell WNR, Fluorocell WDF, Controls (level1, level2 and level 3), Calibrator, Cell clean, Printer papers

#### **4.18.8 Storage and Stability**

- Store reagents, calibrators, and controls according to directions in the manufacturer's documentation (such as a package insert or label recommendation).
- All reagents should be protected from direct sunlight, extreme heat, and freezing during shipment and storage. ..
- Sample stability after collection of venous whole blood:
  - ✓ Samples run within eight hours of collection should be stored at Room Temperature.
  - ✓ Samples run more than eight hours after collection should be refrigerated (2°–8°C).
- Any refrigerator-stored samples should be brought to room temperature before mixing and processing.

#### **4.18.9 Safety**

- i. Avoid exposure to air-conditioning or heating ducts.
- ii. Never use disinfectant product that contains alcohol.
- iii. Never spill liquid on the instrument.
- iv. Prevent blocking of the tubes connected to the instrument and pressure chamber.
- v. Do not disconnect any electrical connection while the power is "ON".
- vi. Use only the approved power cords supplied with the unit.
- vii. Connect power cords only to properly grounded outlets.
- viii. Decontaminate working surfaces twice daily, in the morning and afternoon
- ix. Adhere to safety precautions as stated in the Safety manual
- x. All personal protective equipment (PPE) must be worn when performing this procedure.
- xi. All samples must be regarded as potentially infections.
- xii. Refer to National infection prevention and control Guidelines for health waste management and safety practice.
- xiii. Do not use kit beyond the expiration date which appears on the package label or device in a damaged pouch.

#### **4.18.10 Calibration**

Refer to the XN-1000 and XN-2000 instructions manual for use for description of calibration procedures. Calibrate the XN-1000 and XN-2000 when

- When a major component has been replaced by service.
- After every SIX (6) month during service.
- When indicated by quality control data
- Run the internal quality control samples to verify the performance of the machine

#### **4.18.11 Quality Control**

- a. Three levels of Haematology control must be assayed and evaluated at least once every 24 hours.
- b. Follow the XN1000 & XN2000 instruction manual to run internal quality control samples
- c. Perform patient sample testing if controls are acceptable.

#### 4.18.12 Procedure Steps

##### Manual analysis

- i. Turn the analyser in manual mode by clicking the **Mode Switch** which will lead to the opening of the tube holder door.
- ii. Pre-mix sample in the roller mixer or mix by gently inverting 8 to 10 times
- iii. Place the sample tube in the tube holder.
- iv. Press the **Start Switch** on the analyser and the tube holder slides in, and then aspiration of the sample begins.
- v. After analysis the tube holder will open and remove the sample out, retrieve the sample.

**Note:** There are two types of tube holder;

**Normal sample tube holder:** - the sample can be performed by either removing the cap or without removing the cap

**Micro collection tube holder:** - the sample can be performed after removing the cap of a micro container for sample collection

##### Automated analysis

- i. Turn the analyser in automated mode by clicking the **mode switch**, the tube holder door will close if the analyser was in manual mode.
- ii. Click sample analysis button on the control menu.
- iii. For single sample analysis, register sample by using laboratory number in the **Sample No** space provided, select rack number and position in the **Rack No.** and **position** space and then select **Discrete** to be performed either **CBC** or **CBC+DIFF**
- iv. Put sample in the rack, Place the rack in the input bin or tray and click start.
- v. After analysis remove the rack(s) on the output bin/ tray.
- vi. For batch SAMPLE analysis go to work list on the main menu, click registration "**Regist.**" icon and the room for batch registration will pop-up.
- vii. register sample by using laboratory number in the **Sample No** space provided, select rack number and position in the **Rack No.** and **position** space and then select **Discrete** to be performed either **CBC** or **CBC+DIFF**
- viii. Click **Continue Registration** to register more samples in sequence as arranged in the racks. After the last sample registration click **OK**.
- ix. Click sample analysis button on the control menu.
- x. Register the first sample as done for single sample.
- xi. After all samples are registered, place the rack with samples in the input bin or tray and click start.
- xii. After analysis remove sample rack(s) on the output bin/ tray.

#### **4.18.13      *Biological Reference interval***

Refer to the list of established or adopted biological reference intervals.

#### **4.18.14      *Interpretation and Reporting of Results***

Interpretation of the results should be made in relation to other clinical features of the patients. Further tests might be needed to confirm the conditions.

The results should be reported, communicated as per the established procedure at the institution.

#### **4.18.15      *Limitations of the procedure and sources of error***

The following indicates some of the substances that may interfere with each of the listed parameters.

- WBC: Fragile WBC, neutrophil aggregates, lytic-resistant RBC, NRBC, PLT clumps, cryofibrinogen, Cryoglobulin, paraproteins
- RBC: Elevated WBC count, increased numbers of giant PLT, auto agglutination, in vitro haemolysis
- HGB: Elevated WBC count, increased plasma substances (triglycerides, bilirubin, in vivo haemolysis), lytic-resistant RBC
- MCV: Elevated WBC count, hyperglycaemia, in vitro haemolysis, increased numbers of giant PLT
- PLT: WBC fragments, in vitro haemolysis, microcytic RBC, cryofibrinogen, Cryoglobulin, PLT clumping, increased numbers of giant PLT

#### **4.18.16      *Performance Characteristics***

Refer to the method verification report of this procedure.

#### **4.18.17      *Supporting documents***

Sample collection manual, safety manual and quality manual

#### **4.18.18      *References***

Automated Haematology Analyser XN series (XN-1000). Instruction for use.

## **4.19 PROCEDURE FOR FULLBLOD PICTURE AND RETCULOCYTES USING URIT 5380 ANALYZER**

### **4.19.1 Purpose**

The purpose of this procedure is to provide detailed information on how to perform Full Blood Count and reticulocytes procedure using URIT-5380 5-Part-Diff Auto Haematology analyser.

### **4.19.2 Scope**

This procedure is used in Haematology when performing full blood picture/complete blood count and reticulocytes.

### **4.19.3 Responsibility**

All qualified, trained and competent medical laboratory staff in the laboratory are responsible for implementation of this procedure.

The head of Unit/Section Haematology is responsible for ensuring the effective implementation of this procedure.

### **4.19.4 Principle**

#### **Full Blood Picture**

URIT-5380, which detects the amount and volume distribution of white blood cells, red blood cells and platelets by electrical impedance method (also known as Coulter theory), tests the contents of haemoglobin by colorimetry. It also used for five part differential of white blood cells by the 4-angle laser scattered method. Three separated channels are used for getting the blood cells counting results respectively.

WBC and five part differential data of sheath flow regulator are detected by laser HGB and total amount of WBC is detected by electrical impedance analysis and colorimetric assay in WBC counting chamber. The data of RBC and platelets is detected by electrical impedance in RBC counting chamber. The aspirates, dilutes and mixes the sample and then detects parameters in each counting chamber.

#### **Principles of Reticulocytes**

The staining solution is used to stain Reticulocytes (RETICS) in human blood, so as to observe their morphology and structure, and makes to count the blood cells. The URIT-5380 system Reticulocytes method uses the thiazine dye New Methylene Blue N. The reticulocytes assay is performed in the WOC channel.

### **4.19.5 Sample Requirements**

2-4ml of ant coagulated whole blood collected from EDTA tube.

### **4.19.6 Equipment**

URIT 5380, Roller mixer

### **4.19.7 Materials**

URIT 5part diff diluents, URIT 5part diff Detergent, URIT 5part diff lytic reagent, URIT 5part diff Stealth, URIT Probe cleaner, Test tube racks, Reticulocytes reagent, and PPE



#### **4.19.8 Storage and Stability**

- Store blood Samples at 2-8 °C,
- Store the Controls, Calibrators, reagents and consumables as per manufacturer instructions.

#### **4.19.9 Safety**

- i. Adhere to safety precautions as stated in the Safety manual/IPC guideline
- ii. All personal protective equipment (PPE) must be worn when performing this procedure. All samples must be regarded as potentially infectious. Refer to National infection prevention and control Guidelines for health waste management and safety practice.

#### **4.19.10 Calibration**

Equipment calibration is conducted by the user or biomedical engineer when needed.

#### **4.19.11 Quality Control**

Quality Control is performed daily before running patient samples for accurate results using commercially available controls or in-house made.

#### **4.19.12 Procedure Steps for FBP**

- Enter all the information in the fields available.
- Click next to whole blood in test interface to select the desired operating mode, CBC can choose both in "Whole Blood" and "Diluent".
- It is suggested to switch the mode to the CBC+5Diff+RRBC and run counting again when RRBC Alarms coming out, which is to eliminate the interference of CBC.
- If WBC total number is far less than that of the first counting, it shows that this sample contains insoluble RBC.

#### **Reticulocyte Analysis**

- Click "test" after putting the prepared the reticulocytes sample.
- Input the Serial No. and RBC value and click "Test".

#### **4.19.13 Biological Reference Intervals**

See annex 1.

#### **4.19.14 Interpretation and Reporting of Results**

- Normal results are patient results which fall within the reference range for the particular test.
- Abnormal results are those that fall below or above the reference range.
- Report the obtained results as displayed on the screen or machine print out

#### **4.19.15 Limitation of the Procedure and Sources of Errors**

WBC: platelet aggregation, giant platelets, nucleated RBCs, cry globulins, lyser resistant RBCs in patients with haemoglobinopathies, severe liver disease or neonates

**4.19.16 Performance Characteristics**

Refer verification report.

**4.19.17 Supporting Documents**

Sample Collection Manual, safety manual, and quality manual.

**4.19.18 References**

URIT-5380 5-Part-Diff Auto Haematology Analyser Operation manual.

## **4.20 PROCEDURE FOR FULL BLOOD COUNT USING URIT- 5500 ANALYSER**

### **4.20.1 Purpose**

The purpose of this procedure is to outline the steps to be followed when operating the URIT-5500 automated analyser to determine the Full Blood Count and differential (FBP) for human samples.

### **4.20.2 Scope**

This procedure is applicable during examination of the Full Blood Count using URIT-5500 in the Laboratory.

### **4.20.3 Responsibility**

The Qualified, competent and registered health laboratory practitioners are responsible to carry out this procedure.

Section heads are responsible for ensuring the effective implementation and competency assessment for this procedure

### **4.20.4 Principle**

URIT-5500 uses electrical impedance method (Also known as coulter principle) to detect the amount and volume distribution of white blood cell, red blood cells and platelets. The colorimetry is for determining the content of haemoglobin. The 4-angle laser scattered method is for the five part differential of white blood cells. Three separated channels are used for getting the blood cells counting result respectively. WBC and five part differential data of sheath are detected by laser. WBC and HGB are detected by electrical impedance method and colorimetry in WBC counting chamber. The data of RBC and PLT are detected by electrical impedance methods in RBC counting chamber. In each counting process, the analyser will mix the samples, aspirate, dilute and then measure each parameter.

### **4.20.5 Sample Requirements**

2-4 ml of Ant coagulated whole blood.

### **4.20.6 Equipment**

Perform the procedure for start-up, maintenance, troubleshooting and shut down the URIT- 5500 analyser as per manufacturer's instrument instructions

### **4.20.7 Materials**

Diluents, Sheath, Lyses, Detergent, Control materials, and Gloves

### **4.20.8 Storage and Stability**

- Store reagents, calibrators, and controls according to directions in the manufacturer's documentation (such as a package insert or label recommendation).
- All reagents should be protected from direct sunlight, extreme heat, and freezing during shipment and storage. ..

- Sample stability after collection of venous whole blood:
  - ✓ Samples run within eight hours of collection should be stored at Room Temperature.
  - ✓ Samples run more than eight hours after collection should be refrigerated (2°–8°C).
- Any refrigerator-stored samples should be brought to room temperature before mixing and processing.

#### **4.20.9 Safety**

- Adhere to safety precautions as stated in the Safety manual
- All personal protective equipment (PPE) must be worn when performing this procedure.
- All samples must be regarded as potentially infectious.
- Refer to National infection prevention and control Guidelines for health waste management and safety practice.
- All spills should be wiped thoroughly using 1% sodium hypochlorite solution.

#### **4.20.10 Calibration**

Refer to the URIT-5500 instructions manual for use for description of calibration procedures. Calibrate the URIT-5500 when

- ✓ When a major component has been replaced by service.
- ✓ After every SIX (6) month during service.
- ✓ When indicated by quality control data
- ✓ Run the internal quality control samples to verify the performance of the machine

#### **4.20.11 Quality Control**

- Run internal quality control samples daily before examining patient samples;
- Examine internal quality control samples under the following conditions
  - ✓ Following new calibration curve is established.
  - ✓ When new reagent lot number is loaded.
  - ✓ When there is a change in the system software.
  - ✓ When a system maintenance/ component replacement procedure is performed
- Use the westgard rules to the Review LJ charts to monitor performance of the Quality control.

#### **4.20.12 Procedure Steps**

- Whole blood automated (batch) sampling mode**
  - Click on the “Test”, set the Mode “Routine” ⇒ “Whole blood” ⇒ “Auto” ⇒ “CBC+5DIFF”

- Mix well samples and place into the rack arrange according to sample rack number, **DO NOT OPEN** sample tube
  - Start the loader by clicking start menu bar the analyser will start running, countercheck the result for RRBC.
  - If result sample have **RRBC** switch counting mode to **CBC+5DIFF+RRBC** and then run counting again so as to eliminate the interference of white blood cell coning from the in dissolvable red blood cells
    - **RRBC= Routine** ⇒ **Whole blood** ⇒ **Auto** ⇒ **CBC+5DIFF** + **RRBC**
- ii. **Whole blood single (emergency) sampling mode**
- Click on the **“Test”**, set the Mode **“Routine”** ⇒ **“Whole blood”** ⇒ **“Single”** ⇒ **“CBC+5DIFF”**
  - For **paediatric sample** Click on the **“Test”**, set the Mode **“Routine”** ⇒ **“Whole blood”** ⇒ **“Paediatric”** ⇒ **“CBC+5DIFF”** + **“RRBC”** Mix well and place the sample to the emergency loader, the analyser will start running automatically. **DO NOT OPEN** sample tube unless sample cup used for insufficiency sample. **Diluents mode**

#### **4.20.13 Biological Reference Intervals**

See annex 1.

#### **4.20.14 Interpretation and Reporting of Results**

- Interpretation of results is based on the Biological reference range;
- Normal results are patient results which fall within the reference range for the particular test.
- Abnormal results should be interpreted along with patient clinical features. The following are some of interpretation;
  - i. Low Haemoglobin will indicate anaemia.
  - ii. High Haemoglobin may indicate primary/secondary polycythaemia or dehydration.
  - iii. High haematocrit values are found in cases of plasma depletion e.g. severe burns, dehydration, and polycythaemia.
  - iv. Low haematocrit values are found in patients suffering from anaemia and in fluid overload.
  - v. High WBC counts are seen in leukaemia, some bacterial infections, in infants etc.
  - vi. Low WBC counts are seen in pancytopenia, viral infections, bone marrow aplasia etc
- vii.** If there are no flags on the result, report the FBP and Auto Diff result. You can continue to report the result if the only flags that are present are BAND and/RBC MORPH.
- viii.** Results for known abnormal patients (e.g. haematology patients) may be reported without doing a manual differential count.

- ix. Prepare thin film for manual differential count if the following flags are shown: (BLAST; DFLT; NWBC; FWBC; NRBC) and after consultation with the Haematologist.
- x. Samples exhibiting WBC or RRBC flags must be repeated in the Resistant RBC cycle.
- xi. If WBC Flag with RRBC Flags are indicated, and the sample is from children less than 5yrs rerun sample in Resistant RBC Mode and then perform manual differential count.

#### **4.20.15      *Limitation of the Procedure and Sources of Errors***

- i. Red cell fragments, microcytic RBCs or white cell cytoplasmic fragments may interfere with automated platelet counts.
- ii. Cold agglutinins produce spurious macrocytosis, elevated MCHs MCHCs, falsely decreased RBC counts and HCTs.
- iii. Severely haemolysed samples (in vitro) falsely decrease RBC and haematocrit. Recollect haemolysed samples.
- iv. Abnormal paraproteins found in blood from patients with Multiple Myeloma can falsely increase the HGB. Send to La Crosse for analysis.
- v. Severely icteric samples may falsely elevate the HGB value and related indices. Send to La Crosse for confirmation of results.
- vi. Rocking SAMPLE excessively, may affect the WBC differential.

#### **4.20.16      *Performance Characteristics***

Refer to the method verification report of this procedure.

#### **4.20.17      *Supporting Documents***

Sample collection manual, safety manual, and quality manual.

#### **4.20.18      *References***

1. URIT - 5500 Operators Manual
2. Dacie and Lewis. Practical Haematology, 3<sup>rd</sup> Edition, 2006

## 4.21 PROCEDURE FOR MANUAL RETICULOCYTE COUNT

### 4.21.1 Purpose

The purpose of this procedure is to outline steps to be followed when performing manual Reticulocyte count for human samples.

### 4.21.2 Scope

This procedure is applicable to the Haematology section for performing reticulocyte count.

### 4.21.3 Responsibility

Qualified trained and competent health laboratory practitioners are responsible for doing this procedure.

The head of Haematology section is responsible for ensuring the effective implementation and maintenance of this procedure

### 4.21.4 Principle

A few drops of blood (collected in EDTA) are incubated with new methylene blue solution which stains granules of RNA in red blood cells. A thin smear is prepared on a glass slide from the mixture and reticulocytes are counted under the microscope. Number of reticulocytes is expressed as a percentage of red cells.

### 4.21.5 Sample Requirement

Fresh whole blood sample collected in EDTA tube.

### 4.21.6 Equipment

Microscope ,waterbath, timer, Tally –counter

### 4.21.7 Materials

Reagent	Consumables
New methylene blue solution is prepared as follows: Dissolve 1.0gram of New methylene blue, 0.6gram of Sodium citrate and 0.7gram of Sodium chloride in 100ml of Distilled water	Glass slide Spreader Test tubes (glass or plastic) Immersion Oil Gloves Pasteur pipette

### 4.21.8 Storage and Stability

Reagent should be stored in a refrigerator at 2 – 6°C.

Sample should be stored at room temperature before processing for 2-4 hours and at 2-8 °C for 7 days.

### 4.21.9 Safety

- i. Adhere to safety precautions as stated in the Safety manual
- ii. All personal protective equipment (PPE) must be worn when performing this procedure.

iii. All samples must be regarded as potentially infections.

#### **4.21.10 Calibration**

Perform equipment calibration as per calibration schedule

#### **4.21.11 Quality Control**

Analyse and record Positive and Negative Controls on every batch.

**Note:** Positive Controls are derived from fresh anaemic samples with Haemoglobin less than 7g/dL or neonatal sample.

Negative Controls are derived from fresh adult samples with Haemoglobin of more than 12g/dL

#### **4.21.12 Procedural Steps**

- i. Take 2 drops of the dye solution in to a test tube by means of Pasteur pipette.
- ii. Mix well the blood sample in EDTA tube.
- iii. Add 2 to 4 of the patient EDTA ant coagulated blood to the dye solution in a test tube and mix. (The exact volume of blood to be added to the dye solution for optimal staining depends on the RBC).
- iv. Keep the mixture at 37°C for 15-20 minutes.
- v. Re-suspend red cells by gentle mixing.
- vi. Make film by placing a small drop from the mixture on a glass slide, prepare a thin smear and allow to air dry
- vii. When dry, examine the film use x100 oil immersion without fixing or counterstaining.
- viii. Count 1000 red cells and note the number of red cells which are reticulocytes. Counting error is minimized if size of microscopic field is reduced. This is achieved by using mirror ocular disk inserted in the eye piece

#### **NOTE:**

The exact volume of blood to be added to the dye solution for optimal staining depends on RBC's. A larger proportion of anaemic blood and smaller proportion of polycythaemic blood should be added than normal blood.

#### **Calculations**

$$\text{Reticulocyte \%} = \frac{\text{NR}}{\text{NRBC}} \times 100.$$

Where NR is number of reticulocytes counted

NRBC is number of red blood cells counted.

When there is severe anaemia the reticulocytes count should be corrected by calculating reticulocytes index:

$$\text{Reticulocyte index} = \frac{\text{Observed Reticulocyte\%} \times \text{measured Hb}}{\text{Appropriate normal Hb or PCV}}$$

#### **4.21.13 Biological Reference Intervals**

Adults and children 0.5% - 2.5%. Infant's 2% - 5%.

#### **4.21.14 Interpretation And Reporting Of Results**



### **Interpretation of results**

- i. Mature red cells stain pale green blue and reticulocytes show deep blue precipitates of fine granules and filaments in the form of a network (reticulum). Most immature reticulocyte show a large amount of precipitated material in the form of mass, while the most mature reticulocyte shows only a few granules or strands. Any red cell is considered as a reticulocyte if contain two or more blue stained particles of ribosomal RNA.
- ii. High values indicate increased haemopoietic activity of marrow due to haemolytic process as well as correct response to haematinic treatment.
- iii. Low values indicates ineffective erythropoietic activity as seen in nutritional deficiency e.g., Vitamin B12, folate iron and marrow aplasia.

### **Reporting of Results**

Report obtained results in %

#### **4.21.15      *Limitation of the Procedure and Sources of Errors***

In well stained preparations the following limitations may occur:

- i. Pappenheimer bodies can be identified as a single small dot, less commonly as multiple dots stain a darker shade of blue than does the reticulofilamentous material of the reticulocytes.
- ii. HbH undergoes denaturation in the presence of new methylene blue resulting in round inclusion bodies that stain greenish-blue these can be easily differentiated from reticulofilamentous material.
- iii. Heinz bodies are also stained by new methylene blue, but they stain lighter shade of blue than the reticulofilamentous material.

#### **4.21.16      *Performance Characteristics***

Refer to the method verification report.

#### **4.21.17      *Supporting Documents***

Sample Collection Manual, Quality Manual and Safety Manual

#### **4.21.18      *References***

- Baccarani M, et al. (2006). Evolving concepts in the management of chronic myeloid leukaemia: recommendations from an expert panel on behalf of the European Leukaemia Net. Blood 108:1809.
- User Manual Dacie & Lewis Practical Haematology.

## **4.22 PROCEDURE FOR FULL BLOOD COUNT AND RETICULOCYTE COUNT USING CELL DYN RUBY SYSTEM**

### **4.22.1 Purpose**

This procedure provides instructions for determining Full Blood Count using the CELL DYN(CD) RUBY system. The CELL-DYN Ruby System is a multi-parameter automated haematology analyser designed for in vitro diagnostic use in clinical laboratories.

### **4.22.2 Scope**

This procedure applies to all health laboratory practitioners aimed at operating the Cell Dyn Ruby system.

### **4.22.3 Responsible person**

The Qualified, competent and registered health laboratory practitioners are responsible to carry out this procedure. Section heads are responsible for ensuring the effective implementation and competency assessment for this procedure

### **4.22.4 Principle**

The CELL-DYN Ruby uses flow cytometric techniques to analyse the RBC/PLT, WBC, and NOC populations. This section gives a brief introduction to the principles of flow cytometry. Flow cytometry is a process in which individual cells or other biological particles in a single file produced by a fluid stream are passed through a beam of light. A sensor or sensors measure, by the loss or scattering of light, the physical or chemical characteristics of the cells or particles. Flow cytometry enables the rapid screening of large numbers of cells and provides quantitative cell analysis at the single-cell level

### **4.22.5 Sample requirements**

2-4ml Anti-coagulated whole blood collected in K2 EDTA vacuum tubes. Use fresh whole blood samples (within one hour of collection) to achieve the most reliable result data

### **4.22.6 Equipment**

Perform the procedure for start up, maintenance, troubleshooting and shut down the Cell Dyn Ruby analyser as per manufacturer's instrument instructions

### **4.22.7 Materials**

<b>Reagent</b>	<b>Consumables</b>
WBC Lyse	Printing papers
HBG Lyse	Disposable gloves
Diluent/Sheath	Laboratory coat
Reticulocyte	

### **4.22.8 Storage and stability**

- i. Store reagents, calibrators, and controls according to directions in the manufacturer's documentation (such as a package insert or label recommendation).
- ii. All reagents should be protected from direct sunlight, extreme heat, and freezing during shipment and storage.
- iii. Temperatures below 32° F (0°C) may cause reagent layering that changes the tonicity and conductivity of the reagents..
- iv. Sample stability after collection of venous whole blood:
  - ✓ Samples run within eight hours of collection should be stored at Room Temperature.
  - ✓ Samples run more than eight hours after collection should be refrigerated (2°–8°C).
- v. Any refrigerator-stored samples should be brought to room temperature before mixing and processing.
- vi. A higher incidence of false positive morphological flags may occur for samples analysed at higher ambient temperatures within the operating range of 15°C to 30°C.

**CAUTION:** If any reagent has been frozen, it must not be used.

#### **4.22.9 Safety**

Follow the following precaution requirements to ensure safety, system performance and accurate assay results.

- Consider all clinical samples, reagents, calibrators, and controls that contain human-sourced materials as potentially infectious.
- DO NOT run open tubes in the Closed Mode.
- DO NOT use any Sample ID for a haematology sample that contains any of the following characters: "|", "\", "^", and "&".
- Do not install any software or save file to the system other than specified by Abbott.
- Leave the system power on continuously unless instructed otherwise in a maintenance or troubleshooting procedure, or unless an emergency situation occurs.
- Ensure the system is out of direct sunlight, heat and drafts, and away from any heat-generating device.
- Samples run in the Open Mode must be premixed.
- Wear gloves, laboratory coats, and protective eye wear when handling human-sourced material or contaminated system components.
- Clean spills of potentially infectious materials and contaminated system components with an appropriate disinfectant, such as 0.5% sodium hypochlorite.
- Decontaminate and dispose of all samples, reagents, calibrators, controls, and other potentially contaminated materials prior disposal off.

#### **4.22.10 Calibration**

- Perform calibration as per **the Cell Dyn Ruby operator user manual**.
- Run the internal quality control samples to verify the performance of the machine

#### **4.22.11 Quality Control**

- Quality control by using Cell Dyn controls should be performed on a daily basis to verify the system calibration. Other conditions that drive controls include:
  - ✓ After a reagent lot number change
  - ✓ After maintenance, component replacement, or a field service action
  - ✓ After a software change
  - ✓ Following calibration.
  - ✓ According to regulatory requirements

#### **4.22.12 Procedural steps**

- i. Sign On to update the Operator ID (OPID) before running samples.
- ii. Enter, check, or change operator ID.
- iii. Check waste container level, Empty waste if applicable.
- iv. Check reagent levels in Reagents view. Replace reagent(s) as needed
- v. Check QC Status region.
- vi. Review specific QCID Files and moving average programs as needed
- vii. Verify Background Counts.
- viii. Prepare, run, and verify controls.
- ix. Verify sample acceptability for processing (ID, volume, temperature).
- x. Prepare and run Samples.

#### **4.22.13 Biological Reference Intervals**

See annex 1.

#### **4.22.14 Interpretation and Reporting of Results**

- If the results are inconsistent with clinical evidence, additional testing is suggested to confirm the result.
- Results that fall outside the range of the selected limit set are displayed in colour and underlined on the graph.
  - Yellow indicates that the result exceeded the lower limit and
  - purple indicates that the result exceeded the upper limit.
- Results that exceed a parameter's linear range are indicated by >>>> in place of the result.
- Results that have been determined to require laboratory validation are indicated by an asterisk [\*] next to the result.

#### **4.22.15      *Limitations of the procedure and sources of error***

The following indicates some of the substances that may interfere with each of the listed parameters.

- i.    WBC: Fragile WBC, neutrophil aggregates, lytic-resistant RBC, NRBC, PLT clumps, cryofibrinogen, Cryoglobulin, paraproteins
- ii.   RBC: Elevated WBC count, increased numbers of giant PLT, auto agglutination, in vitro haemolysis
- iii.  HGB: Elevated WBC count, increased plasma substances (triglycerides, bilirubin, in vivo haemolysis), lytic-resistant RBC
- iv.   MCV: Elevated WBC count, hyperglycaemia, in vitro haemolysis, increased numbers of giant PLT
- v.    PLT: WBC fragments, in vitro haemolysis, microcytic RBC, cryofibrinogen, Cryoglobulin, PLT clumping, increased numbers of giant PLT

#### **4.22.16      *Performance Characteristics***

Refer to the method verification reports of this procedure.

#### **4.22.17      *Supporting Documents***

Sample Collection Manual, Safety Manual, and Quality Manual.

#### **4.22.18      *References***

CELL-DYN Ruby System Operator's Manual 9140540G—November 2017.

## 4.23 PROCEDURE FOR COAGULATION TEST USING SYSMEX CA 104 COAGULATION ANALYSER.

### 4.23.1 Purpose

The purpose of this procedure is to provide a guideline on how to perform coagulation tests.

### 4.23.2 Scope

This procedure applies to all personnel in the Laboratory who perform Coagulation test and release results

### 4.23.3 Responsible person

The section heads and technical staffs are responsible for implementing this procedure..

### 4.23.4 Principle

Haemostasis testing - straight forward and compact The CA-104 uses turbidimetry and combines the best of both mechanical and optical detection principles. The lamp intensity automatically adjusts to sample turbidity, which means all samples are properly analysed with constant high quality results. Results are automaticall calculated for PT, INR and APTT. They can be output to an optional external printer.

### 4.23.5 Sample Requirements

- *Sample should be at the laboratory within one hour after collection.*
- *After test procedure SAMPLE will be handled and archived.*

### 4.23.6 Equipment

Sysmex CA 104

### 4.23.7 Materials

Reagent	Consumables
Dade Innovin	Gloves.
Actin FS.	Laboratory coat.
CACL2.	Reaction tubes (cuvette)
Citrol 1	Appendorf pipette
Citrol 2	

### 4.23.8 Storage and stability

Store reagents, calibrators, and controls according to directions in the manufacturer's documentation (such as a package insert or label recommendation). All reagents should be protected from direct sunlight, extreme heat, and freezing during shipment and storage. *Sample Retention for 5 days after final report and stored at 2 – 8°C to maintaining stability and integrity*

#### **4.23.9 Safety**

- i. Decontaminate working surfaces twice daily, in the morning and afternoon
- ii. Temperatures for the room and refrigerator are recorded twice daily, in the morning and afternoon.
- iii. Adhere to safety precautions as stated in the Safety manual
- iv. All personal protective equipment (PPE) must be worn when performing this procedure.
- v. All samples must be regarded as potentially infectious.
- vi. Refer to National infection prevention and control Guidelines for health waste management and safety practice.
- vii. Avoid any contact between hands and eyes and nose during SAMPLE collection and testing.
- viii. Do not use kit beyond the expiration date which appears on the package label or device in a damaged pouch.
- ix. The test device should be stored at 2 -30.0 C. And the test should be performed at room temperature.
- x. Do not reuse the test device.
- xi. All spills should be wiped thoroughly using 1% sodium hypochlorite solution

#### **4.23.10 Calibration**

Calibrate the equipment as per manufacturer's instructions

#### **4.23.11 Quality Control**

Quality control by using Sysmex CA 104 controls should be performed on a daily basis to verify the system calibration. Other conditions that drive controls include:

- ✓ After a reagent lot number change
- ✓ After maintenance, component replacement, or a field service action
- ✓ After a software change
- ✓ Following calibration.
- ✓ According to regulatory requirements

#### **4.23.12 Procedure**

- i. Set cuvette
- ii. Dispense and incubate sample
- iii. Timer count down
- iv. Aspirate start reagent
- v. Dispense start reagent (for PT-Dade innovin 100 microliters,
- vi. For APTT start with Dade Actin incubate it together with sample then followed by Calcium chloride 50 microliter). Measurement is started automatic result is displayed on the LCD screen or printed out automatic to external printer or sent direct to the system.

#### **4.23.13 Biological Reference Intervals**

- Prothrombin Time (PT) 11-14 Seconds
- International normalization ratio (INR) 0.8-1.3
- Activated Partial Thromboplastin Time (APTT) 25-40Seconds

#### **4.23.14      *Limitation of the Procedure and Sources of Errors***

- Failure to enter the correct ISI value will cause incorrect International Normalized Ratio (INR) results.
- Avoid using lipemic samples.
- Avoid using clotted samples.
- Avoid using insufficient samples.
- Avoid using haemolysed samples as they will provide falsely results
- Samples tested after 24 hours may give unreliable results.
- Issues that contribute to variation of the results include: Different reagent and Temperature

#### **4.23.15      *Interpretation Reporting of Results***

- Normal results fall within the reference range for the particular test.
- Abnormal results fall below or above the reference range.
- The instrument can automatically send the result to the host computer if available
- laboratory personnel can read displayed result on its screen read them and send them manually to the responsible area.
- Enter the patient results manually via medipro system.
- Review the patient results and to send electronically to Clinician via medipro.

#### **4.23.16      *Supporting Documents***

Sample collection manual, safety manual and Procedure for reporting of results

#### **4.23.17      *Performance Characteristics***

Refer to the method verification report

#### **4.23.18      *References***

Sysmex CA 104 Operating Manual



## **4.24 PROCEDURE FOR COAGULATION TEST USING SYSMEX CA 500 SERIES COAGULATION ANALYSER.**

### **4.24.1 Purpose**

The purpose of this procedure is to provide detailed instructions on how to perform coagulation assays/ studies by using the Sysmex CA-500 Series Coagulation Analyser.

### **4.24.2 Scope**

This procedure is applicable during operating Sysmex CA500 machine in doing blood coagulation test in the Laboratory.

### **4.24.3 Responsibility**

Qualified and trained Medical Laboratory Personnel are responsible for doing this test procedure. Section heads are responsible for ensuring the effective implementation and competency assessment for this procedure.

### **4.24.4 Principle**

The instrument employs the following detection principle of coagulation method for the provision of the coagulation assays (PT, PTT, Fibrinogen, TT and deficiency factors) results.

#### **Photo-optical Clot detection method.**

The instrument employs photo-optical clot detection method, by using light rays from light –emitting diode (LED) to illuminate the sample/reagent mixture. The instrument detects the changes in the scattered light intensity due to increased turbidity as fibrinogen changes to fibrin. A photo diode absorbs the scattered light and converts the detected light intensity into electrical signals. A microprocessor uses these signals to compute the clotting time of the sample.

#### **Percentage detection method.**

The clotting time is determined by measuring changes in the intensity of light scattered by a sample due to increased turbidity. Immediately after the reagent is added to the sample scattered light intensity is defined as 0%, after the sample is fully turbid and the coagulation is complete, scattered light intensity is defined as 100%. And the coagulation time/clot time is obtained from the coagulation curve by taking the clotting time at a present point on the coagulation curve.

#### **Coagulation Method using Standard Curve.**

The instrument utilizes a standard curve drawn using analysis data or values which have been manually entered to calculate the concentration or percent activity of Prothrombin, Fibrinogen, and other coagulation factors. The standard curve uses the clotting time for the vertical (Y) axis, and the logarithm of percent activity or concentration of the reference plasma for horizontal (X) axis.

### **4.24.5 Sample Requirements**

- Vein puncture blood should be collected in a vacutainer tube with Tri sodium citrate .

- Centrifuge sample at revolutions between 3000rpm to 5000rpm.

#### **4.24.6 Equipment**

- Sysmex CA-500 Series Coagulation Analyser, Roller Mixer, Micropipette(100ul-1000ul) and Centrifuge machine are common requirement instrument for this procedure
- Perform the start up, maintenance, troubleshooting and shut down of the Sysmex CA-500 Series Coagulation Analyser as staining of Electrophoresis Machine as per manufacturer's instrument instructions

#### **4.24.7 Materials**

<b>Reagent</b>	<b>Consumables</b>
Dade Innovin	Reaction tubes
Actin-FS	Micropipette Tips
Calcium	Gloves
Chloride solution	Thermal paper
OV BUFFER	Distilled water
Rinse solution	
CA CLEAN	
Control Material	

#### **4.24.8 Storage and stability**

- Samples, calibrator, and control materials should be stored as per the manufacturer instruction for use.
- Avoid use of expired reagents and consumables.
- Control sample should be frozen at **-20°C** or **-80°C** after reconstitution if not to be used immediately, and they are stable under such conditions for 1 to 5 years respectively.
- Platelet poor plasma should be removed from cells and frozen at -20°C for up to 2weeks or at -70°C for up to 6months

#### **4.24.9 Safety**

- All personal protective equipment (PPE) must be worn when performing this procedure.
- All samples must be regarded as potentially infections.
- Refer to National infection prevention and control Guidelines for health waste management and safety practice.

#### **4.24.10 Calibration**

Calibration of all equipment should be done as per the established schedule, and records should be kept for traceability.

#### 4.24.11 **Quality Control**

Its recommended that control plasma be tested before /during sample analysis or after analyser maintenance has been performed (normal individuals sample pool may be used if the commercial control are no available).

#### 4.24.12 **Procedure Steps**

##### **Prepare Reagents**

- i. Prepare reagents and Control materials as per manufacture instructions (See kit inserts for use)
- ii. Register the reagent volume as follows.
- iii. Press “special menu” key on the task bar.
- iv. Press “set reagent” key in the task bar.
- v. Place the rack of the reagent holder to be registered.
- vi. Enter the reagent volume set on the reagent holder and Click “ENTER” key.
- vii. Press “Quit” key on the numeric keys and confirm entered volumes.
- viii. Press “Main Menu” key on the reagent volume screen. Then renew check screen is displayed , press ”cancel” key , “fix” key or “continue” key to return to the Task bar.

##### • **Running patient samples**

- i. Set sample ID and analysis parameters as follows;
- ii. Specify the rack to be set on the task bar the place “ “and “ “keys to move the cursor to the desired rack position.
- iii. Press “ID No. Entry” key.
- iv. Enter the sample ID number and press “Enter” key, by pressing “C” key, you can erase the information entered (back space function) and cancel registration by pressing “Quit” key
- **Note:** When registering for Quality control, Press “QC” key
- v. Press “Start” key, on the right upper side of the Task bar.
- vi. *Start sample analysis as follows;*
  - a. Check the system display of the instrument; make sure that the Task bar menu on screen displays “Ready”.
  - b. Press “Start” key, then the screen will alert a message to confirm one of the two choices, “First tube” or “Continue”.
  - c. “First tube” key: The instrument to use the first tube in the reaction tube holder.
  - d. “Continue” key: The instrument to continue using the remained reaction tube in the reaction tube holder.

#### 4.24.13 **Biological Reference Intervals**

- See annex 2.

#### 4.24.14 **Interpretation and reporting of Results**

The coagulation factors will be normal if the results are between laboratory's patient population reference range and those with higher value than the laboratory's patient population reference range will be interpreted as abnormal results.

Report results in seconds

**4.24.15      *Limitations of the procedure and sources of error***

SAMPLE must be free from haemolysis, lipemia and icterus

Sample processing should be done within one hour after collection for better results.

**4.24.16      *Performance Characteristics***

Refer to the method verification report of this procedure.

**4.24.17      *Supporting Documents***

Sample collection manual, safety manual and quality manual

**4.24.18      *References***

Sysmex CA-500 Series Operators Manual

## 4.25 PROCEDURE FOR COAGULATION TEST USING SYSMEX CA 600 COAGULATION ANALYSER.

### 4.25.1 Purpose

The purpose of this procedure is to provide a guideline on how to perform coagulation tests. using CA 600.

### 4.25.2 Scope

This procedure is applicable during operating using CA 600. Coagulation analyser in the clinical laboratories

### 4.25.3 Responsible person

It is the responsibility of the laboratory section head to ensure that training and competency of laboratory staff is done on this procedure prior to performing the procedure. Laboratory In-charge, Section heads are responsible to ensure that all users have been trained, understand content of this Procedure and is documented.

### 4.25.4 Principle

Sysmex CA-600 Series Analyser is compact, fully-automated systems featuring, Coagulation Immunologic and Chromogenic measurements in true random access. Results are automatically calculated for PT, INR and APTT. They can be output to an optional external printer.

### 4.25.5 Sample Requirements

- Vein puncture blood should be collected in a vacutainer tube with Tri sodium citrate .
- Centrifuge sample at revolutions between 3000rpm to 5000rpm.

### 4.25.6 Equipment

- Sysmex CA, and 600 Centrifuge machine are common requirement instrument for this procedure
- Perform the start up, maintenance, troubleshooting and shut down of the Sysmex CA-600 Series Coagulation Analyser as staining of Electrophoresis Machine as per manufacturer's instrument instructions

### 4.25.7 Materials

Reagent	Consumables
Dade Innovin	Gloves
Actin FS	Vacuum tubes
CACL2	Laboratory coat.
CA Clean 1 and 11	Reaction tubes (cuvette)
OV Buffer	Pipette and Tips
Distilled water	Thermal Paper
Citrol 1	
Citrol 2	

#### **4.25.8 Storage and stability**

Samples, calibrator, and control materials should be stored as per the manufacturer instruction for use. Avoid use of expired reagents and consumables. Control sample should be frozen at **-20°C** or **-80°C** after reconstitution if not to be used immediately, and they are stable under such conditions for 1 to 5 years respectively.

#### **4.25.9 Safety**

- i. Adhere to safety precautions as stated in the Safety manual
- ii. All personal protective equipment (PPE) must be worn when performing this procedure.
- iii. All samples must be regarded as potentially infections.
- iv. Refer to National infection prevention and control Guidelines for health waste management and safety practice.
- v. Avoid any contact between hands and eyes and nose during SAMPLE collection and testing.
- vi. Do not use kit beyond the expiration date which appears on the package label or device in a damaged pouch.

#### **4.25.10 Calibration**

Calibration is done by the engineer during annual maintenance or as needed

#### **4.25.11 Quality Control**

- Its re commended that control plasma be tested before /during sample analysis or after analyser maintenance has been performed
- Two levels of coagulation controls (citrol 1 and citrol 2) must be assayed and evaluated before running patient samples once a day and when needed.

#### **4.25.12 Procedure**

- i. Wear gloves
- ii. Set cuvette and reagents on board
- iii. Click ID No Entry> Sample Tab
- iv. Add laboratory number in the order ID space
- v. Select tests and click enter and add more test if any.
- vi. Place the sample tube into rack and make sure the barcode faces the barcode reader (if available), then insert the sample rack to the sample area.
- vii. Press start then continue/ first tube.
- viii. Machine automatically starts analysing samples.
- ix. Measurement is started automatic result is displayed on the LCD screen or printed out automatic to inbuilt printer or sent direct to the system as the machine has become interface.

#### **4.25.13      *Biological Reference Intervals***

- Prothrombin Time (PT)      **11-14Seconds**
- International normalization ratio (INR) = **0.9-1.2**
- Activated Partial Thromboplastin Time (APTT) **25-40 Seconds**

#### **4.25.14      *Results Interpretation and Reporting***

- i. Normal results are patient results which fall within the reference range for the particular test.
- ii. Abnormal results are those that fall below or above the reference range.
- iii. Also refer to the Sample Collection Manual
- iv. The instrument can automatically output analysis data to the built-in printer or the host computer if available.
- v. Enter the patient results manually via disa system.
- vi. Review the patient results and to send electronically to Clinician

#### **4.25.15      *Limitations of the procedure and sources of error***

- i. Avoid using lipemic samples.
- ii. Avoid using clotted samples.
- iii. Avoid using insufficient samples.
- iv. Avoid using haemolysed samples as they will provide falsely results.
- v. Samples tested after 24 hours may give unreliable results.

#### **4.25.16      *Performance Characteristics***

Refer to the method verification report of this procedure.

#### **4.25.17      *Supporting Documents***

Sample collection manual, safety manual, quality manual.

#### **4.25.18      *References***

Sysmex CA 600 Operating Manual

## 4.26 PROCEDURE FOR COAGULATION TEST USING SYSMEX CA-660 COAGULATION ANALYZER

### 4.26.1 Purpose

The purpose of this procedure is to provide a detailed instruction on general screening for patients with bleeding disorders and monitoring of patients with circulating anticoagulant. Using Sysmex CA-660 analyser.

### 4.26.2 Scope

This procedure is applicable during operating Sysmex CA-660 analyser at Muhimbili National Hospital, Central Pathology Laboratory.

### 4.26.3 Responsible person

Qualified and trained Medical Laboratory Technician Technologist and Scientists are responsible for doing this test procedure. Quality officer/manager and section heads are responsible for ensuring the effective implementation and competency assessment for this procedure.

### 4.26.4 Principle

**For PT**, Thromboplastin and calcium chloride (PT reagent) is added to citrated plasma at 37<sup>0</sup>C and the time taken for a clot to form is measured. This evaluates the extrinsic pathway of coagulation.

**As for PTT**, PTT reagent is incubated with citrated plasma at 37<sup>0</sup>C. Calcium chloride is added and the time taken for the mixture to clot is measured. This evaluates the intrinsic pathway of coagulation.

### 4.26.5 Sample Requirements

- Vein puncture blood should be collected in a vacutainer tube with iri sodium citrare .
- Centrifuge sample at revolutions between 3000rpm to 5000rpm.

### 4.26.6 Equipment

Sysmex CA-660 and Centrifuge machine are common requirement instrument for this procedure

Perfom the start up, maintenance, troubleshooting and shut down of the Sysmex CA-660 Series Coagulation Analyser as staining of Electrophoresis Machine as per manufacturer's instrument instructions

### 4.26.7 Materials

Reagent	Consumables
PT Reagent Innovin,	Reaction tube
PTT Reagent Actin FS	Thermal paper
Calcium chloride,	Tips
OV Buffer, CA Clean I and II	Gloves
Fibrinogen reagent Thrombin	Micro-pipette



#### **4.26.8 Storage and stability**

Samples, calibrator, and control materials should be stored as per the manufacturer instruction for use. Avoid use of expired reagents and consumables. Control sample should be frozen at **-20°C** or **-80°C** after reconstitution if not to be used immediately, and they are stable under such conditions for 1 to 5 years respectively.

#### **4.26.9 Safety**

- i. Decontaminate working surfaces twice daily, in the morning and afternoon
- ii. Temperatures for the room and refrigerator are recorded twice daily, in the morning and afternoon.
- iii. Adhere to safety precautions as stated in the Safety manual
- iv. All personal protective equipment (PPE) must be worn when performing this procedure.
- v. All samples must be regarded as potentially infectious.
- vi. Refer to National infection prevention and control Guidelines for health waste management and safety practice.
- vii. Avoid any contact between hands and eyes and nose during SAMPLE collection and testing.
- viii. Do not use kit beyond the expiration date which appears on the package label or device in a damaged pouch.
- ix. The test device should be stored at 2 - 30.0 C. And the test should be performed at room temperature.
- x. Do not reuse the test device.
- xi. All spills should be wiped thoroughly using 1% sodium hypochlorite solution.

#### **4.26.10 Calibration**

Calibration is done by the engineer during annual maintenance or as needed

#### **4.26.11 Quality Control**

- It is recommended that control plasma be tested before /during sample analysis or after analyser maintenance has been performed
- Two levels of coagulation controls (citrol 1 and citrol 2) must be assayed and evaluated before running patient samples once a day and when needed

#### **4.26.12 Procedure**

- i. Arrange the sample in the sample rack
- ii. Spin sample at 2500xg - 3000xg for 10 minutes at room temperature
- iii. Arrange the reagents in appropriate place
- iv. Place the reaction tube in appropriate place
- v. Place Thrombin reagent into its place for Fibrinogen if requested
- vi. Close the shield cover and start the analyser

#### **Calculations**

Calculations are done automatically with the analyser.

$$\text{INR} = (\text{PT test} / \text{PT standard})$$

#### 4.26.13 *Biological Reference Intervals*

Parameter	Biological Reference Interval
PT	9.9 – 11.8 Seconds
INR	0.99 – 1.19
APTT	22.1 – 28.1 Seconds
FIBRINOGEN	a. – 2.8 g/dl

- *Therapeutic Range for INR = 2.0 – 3.0*

#### 4.26.14 *Limitations of the procedure and sources of error*

- Clotted, Haemolysed and insufficient sample
- Patients on oral anticoagulant and some common drugs may interfere patients results e.g. warfarin and Aspirin

#### 4.26.15 *Interpretation and Reporting of Results.*

- Interpretation of results is based on the Biological reference range;
- Normal results are patient results which fall within the reference range for the particular test.
- Abnormal results are those that fall below or above the reference range.
- The test report is labelled H: High and L: Low to show the abnormality obtained.

#### **Critical values**

TEST	PANIC /CRITICAL VALUE
PT	>20s
INR	>2s
APPT	>45s
FIBRINOGEN	>50mg/dl

#### 4.26.16 *Performance Characteristics*

Refer to the method verification report of this procedure

#### 4.26.17 *Supporting documents*

Sample collection manual, safety manual and procedure for reporting results

#### 4.26.18 *References*

- Dacie and Lewis Practical Haematology Tenth Edition
- Sysmex manual and reagent, calibrators and controls insert

## **4.27 PROCEDURE FOR COAGULATION TEST USING ACL TOP 500 COAGULATION ANALYSER**

### **4.27.1 Purpose**

The purpose of this procedure is to provide a detailed instruction on general screening for patients with bleeding disorders and monitoring of patients with circulating anticoagulant.

### **4.27.2 Scope**

This procedure is applicable during operating ACL Top 500 CTS Coagulation analyser in the clinical laboratories.

### **4.27.3 Responsible person**

The Qualified, competent and registered health laboratory practitioners are responsible to carry out this procedure. Section heads are responsible for ensuring the effective implementation and competency assessment for this procedure

### **4.27.4 Principle**

There are three fundamental types of photometric assays on this Instrument namely:

#### **☐ Coagulometric(Turbidimetric) Measurement**

Measure and record the amount of time required for a plasma SAMPLE to clot in which fibrinogen is converted to fibrin. Light(671nm) is passing through a sample Light absorption increases as fibrin clot formation progresses and is measured by the photo detector

#### **☐ Chromogenic(Absorbance) Measurements**

Test where the analyte of interest (e.g. protein C, plasminogen) acts directly on a specified synthetic substrate or form inactive complexes (ant thrombin and plasm inhibitor). In most cases, there action is proceeding with the continuous release of paranitroaniline(pNA) from the synthetic substrate. An optical sensor reads light(405nm) that passes through the cuvette. The light is absorbed by the fluid indirect proportion to the concentration of DNA. The amount of light reaching the photo detector is converted into an electrical signal that is proportional to the enzyme activity.

#### **☐ Immunological Measurements**

Relies on the formation of antigen- antibody complexes to affect light transmission. Immunological testing of the ACL TOP uses the 405nm or the 671nm channels depending on the test and the reagent formulation. The light is absorbed by the fluid in the cuvette indirect proportion to the concentration of antigen-antibody complexes

- In PT, Thromboplastin and calcium chloride (PT reagent) is added to citrated plasma at 37°C and the time taken for a clot to form is measured. This evaluates the extrinsic pathway of coagulation.

- In PTT, PTT reagent is incubated with citrated plasma at 37°C. Calcium chloride is added and the time taken for the mixture to clot is measured. This evaluates the intrinsic pathway of coagulation

#### **4.27.5 Sample Requirements**

Plasma on Citrated Blue cap tube/ vacuum

#### **4.27.6 Equipment**

ACL TOP 500 Coagulation analyser

#### **4.27.7 Materials**

<b>Reagent</b>	<b>Consumables</b>
PT Reagent /Recombiplastin 2g, APTT Reagent/ SynthASil Calcium chloride 0.025mol/L Rinsing solution Cleaning solution/Clean A Cleaning agent/clean B Factor v deficient plasma Factor vii deficient plasma Factor Viii deficient plasma Factor ix deficient plasma Standard plasma. Factor diluents Normal Assayed control Hemosil protein s kit(C4bp Buffer-, C4bp latex& Anti-PS mAb latex Low Assayed control High Assayed control Fibrinogen-C Hemosil VWF-Latex reagent kit(latex,Ristocetin,Buffer and Diluent) Protein C kit (activator, diluent and chromogenic substrate)	Reaction cuvettes Printer Sample cup Sample cup adapter Closed sample racks( blue colour) Open sample rack (yellow colour) Reagent racks with adapter/holder Sample tube adapter/holder

#### **4.27.8 Storage and Stability**

- PT, factor VIII are stable at room temperature for 12hrs and one hour respectively
- Other test remain stable at room temperature for four hours
- Freezed sanples at -30oC can be stable for one month

#### **4.27.9 Safety**

- Treat every sample as highly infectious and observe universal safety precautions.
- Temperature is monitored daily, work surfaces decontaminated daily

- iii. Wear appropriate protective equipment such as gloves laboratory coat eye wear or mask
- iv. Dispose all waste materials in accordance with local authority/guideline
- v. Decontaminate working surfaces twice daily, in the morning and afternoon
- vi. Adhere to safety precautions as stated in the Safety manual..
- vii. Refer to National infection prevention and control Guidelines for health waste management and safety practice.
- viii. Wiped all spills thoroughly using 1% sodium hypochlorite solution.
- ix. Use protective garments and gloves when operating, maintenance or servicing the unit and after work is completed, wash hands with disinfectant.

#### **4.27.10 Calibration**

- Calibration of the equipment should be performed as specified by the manufacturer instructions
- Calibrate the coagulation machine under the following conditions:
  - Reagent lot change
  - After major Repair
  - When Q.C is out of range
  - When Analyser prompts you to run a calibrato

#### **4.27.11 Quality Control**

Quality controls are conducted daily specifically at the beginning of each day for routine tests (PT and APTT Tests) and other tests only when equipment is used for processing particular tests. Follow the equipment instruction manual to run internal quality control. At least 2 levels of quality controls should be run accordingly. Interpret the Levy-Jennings chart using the Westgard rules.

#### **4.27.12 Procedure Steps**

##### **Programming Barcoded Samples Using an LIS (Host)**

- Select the Sample Area icon or select Analysis > Sample Area in the menu bar.
- Select an available track position from the track control panel.
- Insert a rack containing bar coded samples into the ACL TOP instrument.
- See Restriction Map for general placement of samples and reagents. The system reads the bar codes and programs the Sample IDs automatically into the Rack Detail screen.
- The programming of the tests is obtained from the LIS, according to the LIS communication configuration (host query or batch downloading).
- Select the Run icon to start the analysis
- **Programming Barcoded Samples after Loading the Rack without an LIS**
  - Select the Sample Area icon or select Analysis > Sample Area in the menu bar.
  - Select an available track position from the track control panel.

- Insert a rack containing bar coded samples into the ACL TOP instrument. The system reads the bar codes and programs the Sample IDs automatically into the Rack Detail screen.
- Select the Rack Details icon to open the Rack Detail screen then Select the Stat option if the sample requires immediate action.
- Select the Add/Remove Tests icon to open the Tests and Profiles window. Program the appropriate tests by selecting the test and/or profile buttons (profiles are underscored).
- Select the Run icon to start the analysis.
- **Programming Non-Barcoded Samples after Inserting the Rack, Without Using an LIS**
  - Select the Sample Area or select Analysis > Sample Area in the menu bar.
  - Select an available track position from the track control panel.
  - Insert the rack into the ACL TOP instrument. Notice the samples positions are displayed with a question mark, indicating that the system identified their presence but had no Sample ID information (unknown samples).

#### **4.27.13 Biological Reference Intervals**

See annex 2.

#### **4.27.14 Interpretation of the Results**

Interpretation of the test results should be made in conjunction with other clinical findings. Critical values

<b>TEST</b>	<b>PANIC /CRITICAL VALUE</b>
PT	>20s
INR	>2s
APPT	>45s
FIBRINOGEN	>50mg/dl

#### **4.27.15 Limitations of the procedure and sources of error**

Clotted, Haemolysed sample and Insufficient samples might affect quality of examination results. Patients on oral anticoagulant and some common drugs may interfere patients results e.g. warfarin and Aspirin

#### **4.27.16 Performance Characteristics**

Refer to the Method verification report.

#### **4.27.17 Supporting Documents**

Sample Collection Manual, Safety Manual, Quality Manual.

#### **4.27.18 References**

ACL top 500 user manual and Package insert sheets CLSI Document C28-A.

## **4.28 PROCEDURE FOR HAEMOGLOBIN ELECTROPHORESIS BY USING GAZELLE™ READER**

### **4.28.1 Purpose**

This procedure provides instruction on steps for Haemoglobin variant detection using Gazelle™ Reader

#### **4.28.2 Scope**

This procedure applies to all Laboratory staff at Haematology section

#### **4.28.3 Responsible person**

The Qualified, competent and registered health laboratory practitioners are responsible to carry out this procedure. Section heads are responsible for ensuring the effective implementation and competency assessment for this procedure

#### **4.28.4 Principle**

##### **Microchip electrophoresis:**

Gazelle Hb variant uses a miniaturized electrophoresis. The haemoglobin in lysed blood sample are separated according to their charge. Different haemoglobin types including A (normal), S (sickle), C (haemoglobin C disease), A2, E (Haemoglobin E disease), and F (Foetal haemoglobin) have different net negative charges in alkaline solution and move along the paper at different speeds due to an applied voltage. The different haemoglobin separates into visible bands on the paper which are converted into signals to be displayed as percentages and types on the screen. This information is used to offer an interpretive statement based on haemoglobin proportions.

#### **4.28.5 Sample Requirements**

A Whole blood sample is required for this procedure

#### **4.28.6 Equipment**

Perform the procedure for start-up, maintenance, troubleshooting and shut down the **Gazelle™ Reader for Haemoglobin electrophoresis** analyser as per manufacturer's instrument instructions

Common testing errors and their remedies can be found in the on- screen Gazelle™ Diagnostic Device User Manual.

#### **4.28.7 Materials**

<b>Reagent and Consumables</b>	
Hb variant cartridges, Vortexer	Sharps container, Personal protective equipment, Hb variant buffer
Eppendorf tubes (1.5mL)	Hb variant marker, Hb variant stampers
Pipettor and pipette tips (20mL and 200mL)	(Blood sample applicator)
Glass slides	Stamper stand
Blood contamination waste container	

#### **4.28.8 Storage and stability**

- i. Blood samples with EDTA, Sodium citrate, ACD, Sodium Fluoride/Potassium Oxalate, and Sodium Heparin anticoagulants may be stored at 2 – 4°C not beyond 14 days after collection.
- ii. Blood samples collected in EDTA anticoagulant containers are stable within to 8 hours at room temperature (up to 35°C) after collection.
- iii. Blood samples are stable after collection up to 24 hours at room temperature (up to 35°C) with Sodium citrate, ACD, Sodium Fluoride/Potassium Oxalate, and Sodium Heparin anticoagulants. Frozen blood samples are not supported.
- iv. Multipack transportation and storage temperature range: 5°C to 45°C
- v. Multipack storage and operating relative humidity range: 5% to 95%
- vi. The multipack expires after 1 year and 3 months

#### **4.28.9 Safety**

- All personal protective equipment (PPE) must be worn when performing this procedure.
- Do not dispose of buffer in a manner that could allow it enter the ground water system.
- Dispose of all used materials at the end of the day.
- The reader contains a lithium ion battery. Keep the device away from heat greater than the operating temperature.
- All samples must be regarded as potentially infectious.
- Refer to National infection prevention and control Guidelines for health waste management and safety practice.

#### **4.28.10 Calibration**

Gazelle™ Reader is factory calibrated and does not require any further calibration.

#### **4.28.11 Quality Control**

Hb variant marker fluid from Gazelle™ Hb variant multipack serves as control for each Hb Variant test.

#### **4.28.12 Procedure Steps**

- i. Add 40 µL of marker fluid and 20 µL of patients' blood to a tube.
- ii. Mix the marker fluid and patient blood using vortex mixer for 20 seconds
- iii. Add 50 µL of buffer to wet cartridge paper with cartridge held at approximately 45°. After water flows in the entire paper, invert the cartridge then insert it into stamper stand for 60 seconds.
- iv. Place the cartridge on the flat surface with stamper stand
- v. Add 20 µL of blood-marker mixture on clean glass slide.
- vi. Quickly wick blood-marker mixture with stamper edge
- vii. Insert the stamper into stamper stand then smoothly stamp on the cartridge for 5 seconds.
- viii. Into each of two wells of the cartridge, add 200µL of the buffer
- ix. Insert the cartridge into Reader without touching cartridge chamber.



- x. Close the lid and click 'start the test' on the reader screen.
- xi. Observe the electrophoretic movement on the screen and read results after 8 minutes
- xii. Export the results to computer or external device for printing.

#### **4.28.13      *Biological Reference Interval***

Not Applicable

#### **4.28.14      *Interpretation and Reporting of Results***

Gazelle™ Reader displays the proportions of haemoglobin types, phenotype and likely sickle cell trait of the patient. This test should be used in conjunction with other with other clinical laboratory and clinical judgment.

#### **4.28.15      *Limitation of the Procedure and Sources of Errors***

- i. The Gazelle Hb variant test may not be accurate for babies born before a week 37- week gestation period, this should be delayed until age plus gestation period reaches 37 or more.
- ii. Hb A2/C/E co-migrate thus measured in combination. Hb A2 alone is below the limit of detection for patients over 6 months.
- iii. This test should be used in conjunction with other with other clinical laboratory and clinical judgment.
- iv. The test cannot give correct results in recently transfused individuals
- v. Pipetting errors

#### **4.28.16      *Performance Characteristics***

Refer to the method verification reports of the procedure.

#### **4.28.17      *Supporting Documents***

Quality Manual, Sample Collection Manual, Safety Manual.

#### **4.28.18      *References***

Gazelle™ Setup Guide Gazelle™HbVariantTest instructionsfor Use

## 4.29 PROCEDURE FOR HEMOGLOBIN ELECTROPHORESIS TEST BY USING SAS 1 AND SAS 2 ELECTROPHORESIS MACHINE

### 4.29.1 Purpose

The purpose of this procedure is to show steps for Alkaline HB Electrophoresis test.

### 4.29.2 Scope

This procedure is applicable during identification of variant and abnormal haemoglobin at the Laboratory.

### 4.29.3 Responsible person

The Qualified, competent and registered health laboratory practitioners are responsible to carry out this procedure. Section heads are responsible for ensuring the effective implementation and competency assessment for this procedure

### 4.29.4 Principle

It uses the principle of Gel electrophoresis. Different haemoglobin has different charges and according to those charges amount of haemoglobin, different chains move at different speed in gel and separates.

### 4.29.5 Sample Requirements

Freshly collected EDTA or Heparin ant coagulated blood. For optimal results, saline washed red cells should be used to prepare lysate. This removes possible interference from plasma proteins.

### 4.29.6 Equipment

- Perform the procedure for start up, maintenance, troubleshooting and shut down the SAS 1 as Electrophoresis process and SAS 2as staining of Electrophoresis Machine as per manufacturer's instrument instructions
- Common testing errors and their remedies can be found in the on- SAS 1 and SAS 2 Electrophoresis Machine User Manual.
- The Drying oven with forced air capable of 60 - 70°C is highly need to be kept available

### 4.29.7 Materials

Reagent	Consumables
<ul style="list-style-type: none"><li>• Prepare the stain ACID BLUE dissolving the concentrated stain (75 ml) included in the kit with 625 of distilled/deionised water (700 ml in total). This solution should be put in litre 1 bottle corresponding to port 6.</li><li>• Prepare the Destain solution as follows. Put DESTAIN A (powder) in the 2 litre bottle, add 1 litre of water, then add DESTAIN B (liquid) and then add 1 litre of</li></ul>	<ul style="list-style-type: none"><li>Pipette</li><li>Haemolysing reagents or Lysing reagents</li><li>Wetting agents (Prep solution)</li><li>Gel</li><li>SAS 1 reagents</li><li>Applicator drawer.</li><li>Electrode</li><li>Gel block remover</li><li>Staining Chamber holder</li></ul>

water. Destain A and B are included in the kit. The destain solution should be in port 2. <ul style="list-style-type: none"> <li>• Put water in the litre bottle of port 1.</li> </ul>	Bottles Blotter paper.
--	---------------------------

#### 4.29.8 Storage and Stability

- **Storage of sample:**
  - ✓ Sample can be stored refrigerated at 2-8°C for up to 1 week.
  - ✓ Freshly collected serum is the sample of choice.
  - ✓ Samples can be stored at 15 - 30°C for up to 4 days, 2 - 6°C for up to 2 weeks or 6 months at -20°C.

- **Storage of reagents and consumables:**

##### SAS-1 IFE Gel

- Store reagents i.e **SAS-1 IFE Gel, Acid Violet Stain, Destain Solution, Wash Solution and Sample Diluent at 15-30°C , and SAS-1 IFE Antisera Kit at 2-6°C**
- Note that deterioration of the gel may be indicated by;
  - ✓ Crystalline appearance indicating the gel has been frozen,
  - ✓ Cracking and peeling indicating drying of the gel or
  - ✓ Visible contamination of the agarose from bacterial or fungal sources.

#### 4.29.9 Safety

- All reagents are for in-vitro diagnostic use only. Do not ingest or pipette by mouth any kit component.
- Wear gloves when handling all kit components.
- Refer to the product safety data sheet for risk and safety phrases and disposal information.
- All personal protective equipment (PPE) must be worn when performing this procedure.
- All samples must be regarded as potentially infectious.
- Refer to National infection prevention and control Guidelines for health waste management and safety practice.

#### 4.29.10 Calibration

- Calibration of the equipment should be performed as specified by the manufacturer instructions
- . Records should be kept for traceability.
- Run Internal quality control samples to verify performance of the machine following calibration process

#### 4.29.11 Quality Control

Commercial controls should be run along with the patient samples to confirm the presence of monoclonal banding in all antisera lanes.

#### 4.29.12 Procedure Steps

Mix 200 u/L of well mixed whole blood with 1000UL of saline solution.

- i. Centrifuge to 3000 rpm for 2 minutes times 2, the Final centrifugation, remove 1000uL of supernatant and treat the remaining sample as whole blood, or remove all of the supernatant and treat the remaining sample as washed packed cells.
- ii. RBC Lysis, Dilute patients sample and controls to a final concentration of 1.5 g/dl. For example
  - ✓ Hb 9.7 g/dl 1:6 dilution in lysing reagent included in the kit(50ul + 200ul)
  - ✓ Hb 11.2 g/dl 1:7 (50ul +300ul)
  - ✓ Control AFSA2 Hb 6.1 1:4 (50ul + 150ul)
- iii. Leave the RBC lysing reagent for 20-30 minutes at room temperature.
- iv. Mix the RBC in lysing reagent and then pipette 35ul of sample into the small well of the sample tray.
- v. Switch on SAS1, press ENTER, select program 1, press ENTER and then + to start the program, When SAS1 reaches the 25<sup>0</sup>C temperature, it will open.
- vi. Carefully place the sample tray onto the applicator drawer, Ensure that the tray is pushed firmly down into position.
- vii. Dispense 400ul of REP prep onto the heat sink, Place the gel onto the heat sink, agarose side up, aligning the positive and negative sides with the corresponding electrode posts, taking care to avoid air bubbles under the gel.
- viii. Blot the surface of the gel with a blotter C, discard the blotter.
- ix. Attach the electrodes onto the top side of the electrode posts so that they are in contact with the gel blocks.
- x. Place the cover over the gel and electrodes and press firmly for 5 seconds to ensure contact.
- xi. Place 1 applicator blade assembly into the top position on the equipment.
- xii. Place any key to start the migration.
- xiii. Program 1-HEMOGLOBIN: 200 Volts, 30 mins, 25<sup>0</sup>C, 2 applications
- xiv. Following electrophoresis, remove the cover, remove the electrodes and both gel blocks using the Gel block remover.
- xv. Attach the gel to staining chamber holder.
- xvi. Select program 1 on SAS2, following the prompts, Stain, Destain and Dry the gel.

#### **4.29.13      *Biological Reference Interval***

- HbA1- 95-98%,
- HbA2 - 2-3%
- HbF- 0.8 -2%
- HbS- 0%

#### **4.29.14      *Interpretation and Reporting of Results***

- The majority of monoclonal proteins migrate in the cathodic, gamma region of the protein pattern, but due to their abnormal nature, they may migrate anywhere within the globulin region on protein electrophoresis.

- The monoclonal protein band on the immunofixation pattern will occupy the same position and shape as the abnormal band on the serum protein pattern.
- The abnormal protein is identified by the antiserum type it reacts with. When low concentrations of abnormal protein are present,
- the abnormal band may appear as a band within the normal polyclonal immunoglobulin. A band can also be seen within a polyclonal background when there is a large polyclonal immunoglobulin presence also.
- Report If abnormal the following condition can occurs depends on types of abnormal Hb, Higher than normal amount of both Hb A2 and Hb F may means a mild form of thalassemia is present, High level of HbF may be seen in a rare condition called hereditary persistence of foetal haemoglobin, high level of Hb A1 than HbS means a carrier or traits and HbS in high amount means Sickle cell disease.
- Report If HbA1 and HbA2 observed report as a normal parameter by using alkaline HB gel electrophoresis.

#### **4.29.15      *Limitations of the procedure and sources of error***

- With this method of alkaline Hb gel electrophoresis it is used to identify only four types of Hb as follows HbA1, Hb F, HbS and HbA2. Antigen excess will occur if there is not a slight antibody excess or antigen / antibody equivalence at the site of precipitation
- Antigen excess in IFE is usually due to an excess of the immunoglobulin in the patient sample. Antigen excess is characterised by prozoning (unstained areas in the centre of the immunofixed protein band, with staining around the edges). A higher dilution of the sample should be used in this event to optimise the immunoglobulin concentration.
- Non-Specific Precipitation in All Immunoglobulin Lanes.
  - Occasionally a completed IFE plate exhibits a precipitate band in the same position in every pattern across the plate. This may result from:
    - a) IgM monoclonal immunoglobulins.
      - IgM monoclonal proteins can adhere to the gel matrix. A band will appear in all 5 antiserum lanes of the gel. However, where the band reacts with a specific antiserum for the heavy chain and light chain, there will be an increase in size and staining intensity of the band, allowing the immunoglobulin type to be identified.
      - Samples with high titres of Rheumatoid Factor or other immune complexes may show a precipitate band at the sample application point. Reducing the sample with DTT or  $\beta$ -2-mercaptoethanol can eliminate this non-specific reaction (Mix 190 $\mu$ L of diluted serum to 10 $\mu$ L of 1% (w/v) DTT in 0.85% saline solution or mix 100 $\mu$ L of serum with 10 $\mu$ L of a 1:10 dilution of  $\beta$ -2-mercaptoethanol in water Perform the IFE as usual.

#### **Fibrinogen.**

- Fibrinogen, if present in the sample, will show as a discrete band in all lanes of the immunofixation pattern. Fibrinogen is present in plasma, and sometimes in the serum of patients on anticoagulant therapy.
- Reaction With Kappa or Lambda Light Chain Antisera but No Reaction with IgG, IgA or IgM Heavy Chain Antisera. Samples showing this pattern may either have a free light chain monoclonal gammopathy or they may have an IgD or IgE monoclonal protein. In this situation, the IFE should be repeated, substituting IgD and IgE antisera for two of the other heavy chain antisera.
- Band In Gamma Region Showing No Reactivity With IFE Antisera. C Reactive Protein (CRP) may be detected in patients with acute inflammatory response CRP appears as a narrow band at the cathodic end of the serum protein pattern. Elevated Alpha1- Antitrypsin and Haptoglobin are supportive evidence for CRP.
- Non-Reactivity With Kappa and Lambda Antisera Occasionally a sample will have a reaction with a heavy chain antiserum but no light chain reaction is obvious. In this situation, the following need to be ruled out.

#### **4.29.16      *Performance Characteristics***

Refer to the report of method verification of this procedure.

#### **4.29.17      *Supporting Documents***

Sample collection manual, Safety manual and Quality manual.

#### **4.29.18      *References***

District laboratory practice in tropical countries part 2- By Monica Cheesbrough

## **4.30 PROCEDURE FOR METHEMOGLOBIN REDUCTION TEST FOR GLUCOSE-6 PHOSPHATE DEHYDROGENASE (G-6PD)**

### **4.30.1 Purpose**

This procedure is used to identify the deficiency of the enzyme normally found in red blood cells metabolism. Deficiency of this enzyme is often manifested in haemolytic anaemia, especially after the affected person has ingested certain oxidative agents.

### **4.30.2 Scope**

This procedure is used in Haematology when performing Glucose-6 Phosphate Dehydrogenase (G-6PD).

### **4.30.3 Responsible person**

The Qualified, competent and registered health laboratory practitioners are responsible to carry out this procedure.

Section heads are responsible for ensuring the effective implementation and competency assessment for this procedure

### **4.30.4 Principle**

Sodium nitrite converts (oxidize) haemoglobin to methemoglobin. In the presence of methylene blue, the formed methemoglobin is reduced to haemoglobin at a rate proportional to the G-6PD present (the sufficient the red cells have, the rapid reduction of methemoglobin to haemoglobin will be).

### **4.30.5 Sample Requirements**

2-4mls Venous blood collected in EDTA containers

### **4.30.6 Equipment**

Water bath

### **4.30.7 Materials**

Reagent 1: Sodium nitrite: 5gram Glucose, Reagent 2: Methylene blue, laboratory coat, Gloves.

Preparation

- Measure 1.25gm of sodium nitrite plus 5.00gm glucose
- Put the contents in one flask, make volume to 100mls with distilled water
- Weigh 0.15gm of trihydrated methylene blue dissolved in one litre of distilled water
- Test tube, Micro-pipette, 2ml pastor pipette, Rack

### **4.30.8 Storage and Stability**

Sample, reagents, calibrators and control materials should be stored as per the manufacturer instructions

#### **4.30.9 Safety**

- 
- All personal protective equipment (PPE) must be worn when performing this procedure.
- All samples must be regarded as potentially infectious.
- Refer to National infection prevention and control Guidelines for health waste management and safety practice.

#### **4.30.10 Calibration**

Calibration of water bath should be done, the report and certificates be kept for traceability purpose.

#### **4.30.11 Quality Control**

Control materials (positive and negative controls) are run along with the patient samples.

#### **4.30.12 Procedure Steps**

- i. Arrange three tubes
- ii. Label the tubes 1 for the positive control, 2 for the negative control and 3 for the test
- iii. To the positive control tube, add 0.1ml sodium nitrite
- iv. Negative no reagent added
- v. To the test tube No.1 (Test), add 0.1methylene blue plus 0.1 sodium nitrite
- vi. Add 2mls of blood, deficient or normal to both positive and negative control tubes.
- vii. Add 2mls of patients' blood to the patient test tube.
- viii. Mix well by inverting several times
- ix. Incubate un-stoppered and undisturbed in a water bath for three hours at 37°C
- x. After incubation mix well, label three tubes 1,2 and 3
- xi. Take 0.1mls from each tube above and transfer into the prepared tubes
- xii. Add 10mls of Distilled water into each prepared tubes
- xiii. Read your test after 6 minutes visually compare the results of the unknown to the positive and negative reference tubes. Report test as being positive or negative

**Note: in G-6-PD deficiency, the colour in the sample tube is dark grey or brown identical to the positive control tube. The intensity of the colour will be proportional to the deficiency.**

#### **4.30.13 Biological Reference interval**

Not Applicable

#### **4.30.14 Interpretation and Reporting of Results**

- Report the results as POSITIVE or NEGATIVE
- Dark grey **O** brown colour identical to positive control - Positive
- Normal blood yields a colour similar to that in the normal reference tube



- Blood from deficient subjects give a brown colour similar to that in the deficiency deference tube
- Heterozygous give intermediate Reaction
- Normal blood
- All the red cells are stained 1 in G6PD Hemi zygotes, the majority of cells are unstained

#### **4.30.15      *Limitations of the procedure and sources of error***

- Thermal stability, Red cell G6PD Activity, Elevated Reticulocytes in infants
- Reticulocytes contain more of enzyme than do mature red cells hence a deficiency person mat show negative reaction if his Reticulocytes count is elevated

#### **4.30.16      *Performance Characteristics***

Not Applicable

#### **4.30.17      *Supporting Documents***

- Sample collection manual
- Safety manual
- Quality manual.

#### **4.30.18      *References***

- E.A.COX
- DACIE
- The morphology of human blood cells, fifth edition by Lemuel Diggs.

## **4.31 PROCEDURE FOR HAM TEST FOR PAROXYSMAL NOCTURNAL HEMOGLOBINURIA**

### **4.31.1 Purpose**

This procedure provides instructions for determination of susceptible erythrocytes to haemolysis in acidified serum.

### **4.31.2 Scope**

This procedure is applicable during Demonstration of HAM (Acidified serum Lysis Test) in the Haematology Units.

### **4.31.3 Responsible person**

The Qualified, competent and registered health laboratory practitioners are responsible to carry out this procedure. Section heads are responsible for ensuring the effective implementation and competency assessment for this procedure

### **4.31.4 Principle**

In Paroxysmal Nocturnal Haemoglobinuria the red cells (Erythrocytes) are unusually susceptible to Lysis. This can have demonstrated in vitro by variety of tests e.g. acidified serum (HAM). The test involves placing red blood cells in mild acid (increased RBC fragility); a positive result indicates PNH.

### **4.31.5 Sample Requirements**

Venous blood collected in EDTA containers (Patient's). Fresh normal Serum, group AB or ABO compatible with the patient's sample. Fresh whole blood sample for control

### **4.31.6 Equipment**

Water bath, timer, centrifuge machine.

### **4.31.7 Materials**

0.2 N HCL, Test Tubes, Pipettes, Tips, Gloves, Normal saline, Heat inactivated saline

### **4.31.8 Storage and Stability**

Samples, reagents and control materials should be stored as per the manufactures instruction of use.

### **4.31.9 Safety**

- Decontaminate working surfaces twice daily, in the morning and afternoon
- All personal protective equipment (PPE) must be worn when performing this procedure.
- All samples must be regarded as potentially infections.
- Refer to National infection prevention and control Guidelines for health waste management and safety practice.

#### **4.31.10 Calibration**

Calibrate all auxiliary equipment's (Light Microscope, Stop watch, Water bath)

#### **4.31.11 Quality Control**

Control sample should be run along with the patient samples.

#### **4.31.12 Procedure Steps**

- i. Put 0.5 ml samples of fresh normal serum, group AB or ABO compatible with patient's blood into 6 tubes (3 pairs).
- ii. Place two tubes at 56°C for 10-30 min to inactivate complement.
- iii. Keep the other 2 pairs of tubes at room temperature and add to the serum in 2 of the tubes 0.05 ml of 0.2N HCL.
- iv. Add similar volumes of acid to the inactivated serum samples. Place all the tubes in a 37°C water bath.
- v. While serum samples are being dealt with, wash samples of patient's red cells and of control normal red cells twice in saline and prepare 50% suspensions in the saline.
- vi. Then add 0.05 ml of these cell suspensions to one of the tubes containing. Unacidified fresh serum, acidified fresh serum, and acidified inactivated serum, respectively. Mix the contents carefully and centrifuge them after about a 1 hour.
- vii. If the test cells are from a patient with PNH, they will undergo definite Lysis.
- viii. The unacidified tube must show no more than a trace of haemolysis.

#### **4.31.13 Biological Reference Interval**

Not Applicable

#### **4.31.14 Interpretation and Reporting of Results**

If the test cells are from a patient with PNH, they will undergo definite Lysis. Therefore, Haemolysis in the acidified tube is indicative of PNH. Un acidified tube must show no more than a trace of haemolysis

#### **4.31.15 Limitations of the procedure and sources of error**

A false positive is sometimes seen in congenital spherocytic anaemia. If this is suspected, repeat the test using acidified serum previously inactivated at 56°C for 30 minutes.

#### **4.31.16 Performance Characteristics**

Refer to the method verification report of this procedure.

#### **4.31.17 Supporting Documents**

Sample collection manual, Safety manual, Quality manual.

#### **4.31.18 References**

Dacie and Lewis practical Haematology

## **CHAPTER 5: CLINICAL CHEMISTRY AND IMMUNOLOGY**

---

### **5.1 PROCEDURE FOR BLOOD GLUCOSE BY USING ACCUCHECK GLUCOMETER**

#### **5.1.1 Purpose**

This procedure provides instructions for use of blood glucose test strips for determination of Blood Glucose level. Blood glucose is measured mainly in the diagnosis and management of diabetes mellitus.

#### **5.1.2 Scope**

This procedure will be used for Blood Glucose testing in the laboratory and at point of care testing sites (POCT).

#### **5.1.3 Responsibility**

Qualified and competent registered and licensed Health laboratory practitioners and Trained health care providers respectively are responsible for doing this test procedure.

The head of clinical chemistry section is responsible for ensuring the effective implementation of this procedure.

#### **5.1.4 Principle**

The test strips contain a capillary that sucks up a reproducible amount of blood. Glucose in the blood reacts with an enzyme electrode containing Glucose oxidase (or Glucose dehydrogenase). The enzyme is reoxidized with an excess of a mediator ferricyanide ion, a ferrocene derivative or osmium bipyridyl complex. The mediator in turn is reoxidised by reaction at the electrode, which generates an electrical current. The total charge passing through the electrode is proportional to the amount of glucose in the blood that has reacted with enzyme.

#### **5.1.5 Sample requirements**

- i. Capillary or 1ml Fluoride-oxalate venous anticoagulated blood (fasting, post-prandial, or random samples). Do not collect blood from an arm receiving an I.V. infusion. *Fasting samples*: This refers to blood collected after a period of no food intake. For adults the fasting time is usually 10 to 16 hours. For children the fasting time is 6 hours unless a longer time is indicated, e.g. when investigating hypoglycaemia. The drinking of plain water is permitted.
- ii. *Post-prandial samples*: This describes blood collected after a meal has been taken. The sample is usually taken as a 2 hour post - prandial samples.
- iii. *Random samples*: This refers to a blood sample collected at any time, regardless of food intake.

#### **5.1.6 Equipment**

Glucometer

## **Maintenance**

Conduct **maintenance** as required by manufacturer instructions

### **5.1.7 Materials**

Glucose test strips, Lancets, Cotton wool or gauze or alcohol swab, Sharp box or Container, waste bin, Disposable gloves, Laboratory coat

### **5.1.8 Storage and stability**

All related materials should be stored as the per manufactures instructions.

Sample should be processed within 1hour after collection

### **5.1.9 Safety**

- i. All samples must be considered as potentially infectious and must be handled and examined with care.
- ii. All person applicable protective equipment (PPE) should be worn when performing procedure
- iii. Adhere to safety precautions as stated in the Safety manual

Refer to National infection prevention and control Guidelines for health waste management and safety practice.

### **5.1.10 Calibration**

Equipment should be calibrated as per schedule.

### **5.1.11 Quality control**

Process internal quality control before examining the patient samples on daily base

### **5.1.12 Procedure Steps**

- i. Compare the code number on the chip with the corresponding code number on the label of the test strip container where applicable.
- ii. The three-digit number on the code chip (e.g.689) must match the three-digit number on the label. (Leave the meter turned off).
- iii. Gently slide the code chip into the slot on the side of the meter. (You must feel the code lock into place)
- iv. To turn on the Glucose meter, press the S button and hold it down for more than 3 seconds until the depicted display appears.
- v. Wear gloves clean the patient's finger using the alcohol swab and allows it to dry.
- vi. Take one strip from the container. Close cap tightly and make sure the yellow color in the round window on the back of the test strip matches the yellow color above 0 mg/dL on the container. If it looks green do not use it.
- vii. Insert the test strip, with the orange pad facing up, until it will go no further into the meter. Do not bend the test strip. (The arrow heads are almost no longer visible when the test strip is inserted correctly.)
- viii. Make sure the code on the meter matches the code on the test strip container.

- ix. When you see the flashing blood drop, hold the lancet device against the side of patient fingertip and press the release button.
- x. Gently squeeze patient fingertip to get a drop of blood.
- xi. Once the the blood drop appears on the screen, you have 2 minutes to apply the drop of blood.
- xii. Touch the blood drop to the center of the square orange pad. Do not bend the test strip.
- xiii. An hourglass symbol appears on the screen, and then the test result appears.
- xiv. To remove the lancet, take off the lancet device cap and point the lancet end away.
- xv. Slide out the rejector to discharge the lancet into an appropriate container for sharp objects.
- xvi. Applying Blood with Test Strip outside of the Meter.
- xvii. Take the test strip out of the meter
- xviii. Touch the center of the square orange pad to the drop of blood. Do not bend the test strip.
- xix. Within 20 seconds, insert the test strip, with the orange pad to the drop of blood.

#### **5.1.13 Biological Reference Intervals**

<b>Fasting Blood glucose (mmol/L)</b>	<b>Random Blood Glucose</b>
Blood/Plasma: 3.9 – 5.6 mmol/L (70 - 100 mg/dl)	≤6.9 (125 mg/dl)

#### **5.1.14 Interpretation and reporting of results**

- i. Results are displayed in either mg/dl or mmol/liter depending on which unit of measurement is selected. Report the value in the agreed SI unit.
- ii. If the result is lower than 10mg/dL (0.6mm/L) “Lo” is displayed instead of a result.
- iii. “Lo” may indicate that your blood is very low.
- iv. If the result is higher than 600mg/dL (33.3mmol/L), “Hi” is displayed instead of a result.
- v. Fasting blood glucose between 5.6 – 6.9 mmol/L (100 – 125 mg/dl) indicates high risk to diabetes.
- vi. Two separate test results of 7.0 mmol/L (126 mg/dl) or higher indicate diagnosis of diabetes.

<b>• Critical value</b>	
Fasting blood glucose	<2mmol/L
	>20mmol/L

#### **5.1.15 Limitation of the Procedure and Sources of Error**

- i. Falsely elevated glucose results may be obtained when a person’s blood contains bilirubin (unconjugated) >340 µmol/l (>20 mg/dl), triglycerides >57 mmol/l

- ii. Abnormal uric acid levels may also interfere with test results. Caution is needed in the interpretation of neonatal applicable blood glucose values  $<2.8$  mmol/l ( $<50$  mg/dl).
- iii. Abnormal haematocrit values may affect test results.
- iv. Haematocrit levels below 0.20 may cause falsely low glucose values when the glucose concentration is less than or equal to 11.1 mmol/L. Values above 0.55 may cause falsely low glucose values when the glucose is above 11.1 mmol/l.

#### **5.1.16 Performance Characteristics**

Refer to the verification report

#### **5.1.17 Supporting Document**

Not applicable

#### **5.1.18 References**

ACCU-CHEK Active user's manual.

## **5.2 PROCEDURE FOR TESTING BLOOD GLUCOSE BY GLUCO PLUS**

### **5.2.1 Purpose**

This Standard Operating Procedure (SOP) is aimed to describe step by step on how to operate **Glucoplus device**

### **5.2.2 Scope**

This procedure for Gluco-plus device will be used for blood glucose chemistry testing in health facility in Tanzania

### **5.2.3 Responsibility**

Trained, qualified and competent laboratory registered practitioners are responsible for performing this procedure.

The head of section for chemistry is responsible for ensuring the effective implementation and competency assessment for this procedure .

### **5.2.4 Principle**

- Not applicable

### **5.2.5 Sample Requirements**

Whole blood

### **5.2.6 Equipment**

Perform the procedure for start-up, maintenance, troubleshooting and shut down the Gluco-plus as per manufacturer's instrument instructions

### **5.2.7 Materials**

Test strips and Lancing device

### **5.2.8 Storage and Stability**

- Gluco-plus strips should be stored at room temperature
- All reagents should be protected from direct sunlight, extreme heat, and freezing during shipment and storage.
- Temperatures below 32° F (0°C) may cause reagent layering that changes the tonicity and conductivity of the reagents.
  - Sample stability after collection of venous whole blood:
    - ✓ Run Samples within one hour of collection.

### **5.2.9 Safety**

- Decontaminate working surfaces twice daily, in the morning and afternoon
- All personal protective equipment (PPE) must be worn when performing this procedure.
- All samples must be regarded as potentially infections.
- Refer to Manufacturer instruction, National infection prevention and control
- Guidelines for health waste management and safety practice.

### **5.2.10 Calibration**



Not Applicable

### 5.2.11 Quality Control

Control solution

Test prepared GLUCOPLUS control Solution;

- i. Once per week
- ii. When opening new strips kit
- iii. When you suspect the meter or test strips are not working properly.
- iv. If you drop/damage the meter.
- v. Record results on QC Form.

### 5.2.12 Procedural Steps

Step	Action
<b>Changing strip code</b>	
1	Check the code on the test strip vial before inserting the test strip.
2	Insert the test strip to turn ON the meter and match the code on the meter with the code on the strips vial.
3	If the code is already matched press OK to go to APPLY SAMPLE screen.
4	If the code in Meter does not match the code on the test strip vial, Press S button until you hear a beep sound. Press <b>S</b> or <b>M</b> to match the code number on the test strips vial.
<b>Setting time</b>	
1	Switch on the analyser
2	Press <b>S</b> button until you hear a beep sound. Press off button to save the strip code.
3	Month number will blink use S and M button to select the required month
4	Press the off button to save month and date number will blink and use S and M button to select the required date.
5	The time hours will blink use S and M to set time .
<b>Performing a Quality Control test</b>	
1	Perform weekly and as per meter (machine) protocol.
2	Control used is <b>GLUCOPLUS Selected Control solution</b> .
3	Prepare and Apply Control solution.
4	Touch the sample tip of the test strip to the control drop. Verify check window filled.
5	Meter display will count down from 5 to 1 and then display result.
6	Compare the control solution results with correct Control range printed on test strips vial. (Example; 6.2 – 8.2 mmol/L). If the result are not within control range repeat the control solution test.
<b>Testing Blood</b>	
1	Use lancing device to puncture site, normally fingertip.
2	Insert a test strip into the strip port to turn on meter.
3	Touch the blood sample to the sample tip at the end of the test strip.
4	The meter display will count down from 5 to 1 and then display result.
5	If the “HI” or “LO” message appears on the meter, the result is above 33.3 or below 1.1. Repeat test to verify.
<b>Error Codes</b>	
<b>E-1</b>	Problem with Meter – Do not use the meter

<b>E-2</b>	Meter or strip Problem – Repeat the test with New strip.
<b>E-3</b>	Meter was not ready – Repeat the test with a new strip. Apply SAMPLE or CONTROL appears on the display.
<b>E-4</b>	Strip Problem – Repeat test with a new strip.
<b>E-5</b>	Strip problem or Sample too small – Repeat the test with a new strip and new sample.
<b>HI.E</b>	Temperature too high—repeat test in a cooler area.
<b>LO.E</b>	Temperature too low—repeat test in a warmer area.
<b>E-6</b>	Battery LOW — replace battery soon.

### 5.2.13 Biological Reference Interval

Fasting Blood glucose (mmol/L)	Random Blood Glucose
Blood/Plasma: 3.9 – 5.6 mmol/L (70 - 100 mg/dl)	≤6.9 (125 mg/dl)

### 5.2.14 Interpretation and Reporting of Results

- vii. Results are displayed in either mg/dl or mmol/liter depending on which unit of measurement is selected. Report the value in the agreed SI unit.
- viii. If the result is lower than 10mg/dL (0.6mm/L) “Lo” is displayed instead of a result.
- ix. “Lo” may indicate that your blood is very low.
- x. If the result is higher than 600mg/dL (33.3mmol/L), “Hi” is displayed instead of a result.
- xi. Fasting blood glucose between 5.6 – 6.9 mmol/L (100 – 125 mg/dl) indicates high risk to diabetes.
- xii. Two separate test results of 7.0 mmol/L (126 mg/dl) or higher indicate diagnosis of diabetes.

• Critical value	
Fasting blood glucose	<2mmol/L
	>20mmol/L

### 5.2.15 Limitation of the Procedure and Sources of Errors

If the “HI” or “LO” message appears on the meter, the result is above 33.3 or below

### 5.2.16 Performance Characteristics

Refer the method verification reports from for this procedure and equipment manufacturer user manual

### 5.2.17 Supporting document

Sample Collection Manual, Safety Manual, Quality Manual

### 5.2.18 References

1. User manual for Gluco-plus
2. Manufacturers package insert

### **5.3 PROCEDURE FOR URIT 50 (URINE CHEMISTRY ANALYZER)**

#### **5.3.1 Purpose**

This procedure is provides description for performing urine biochemistry by using URIT 50 semi-automated Urine analyser.

#### **5.3.2 Scope**

This procedure is applied for testing Urine sample at the health facilities in Tanzania.

#### **5.3.3 Responsibility**

A trained and competent health laboratory practitioners are responsible for performing this procedure. The head of section of biochemistry and parasitology is responsible of ensuring the implementation of this procedure.

#### **5.3.4 Principle**

The analyser measures change of the reflectance of reagent strips pads, A detector integrated in the system is composed of light source and a light receiver, the light from which goes through in the spherical integrator and reflect to the reagent pads on strip. The absorbance (reflectance) varies according to the color of reagent pads, the darker of the reagent pads higher the absorbance is and less light is reflected. Conversely the lighter the reagent pad is the lower the absorbance is and more light is reflected degree of color developed is direct proportion to the concentration of analyte in urine”.

#### **5.3.5 Sample Requirements**

4mls of uncentrifuged mild stream urine sample is used.

#### **5.3.6 Equipment**

Urit-50

#### **5.3.7 Materials**

Disposable gloves, Laboratory coats, Urine container, Waste container, Marker pen, Urine strips from urit G10, G11 or G14, Gauze

#### **5.3.8 Storage and Stability**

- i. Store urine sample at room temperature for 30 minutes to 2 hours or 24 **hours** in refrigerator.
- ii. Reagent strips and calibrator should be stored to free and clean area at 37°C
- iii. Control materials should be stored as per the manufacturers instructions

### **5.3.9 Safety**

Samples and control materials at this section should be treated as infectious material and should be handled careful.

### **5.3.10 10.0. Calibration**

Not applicable

### **5.3.11 Quality Control**

- i. Put on PPE
- ii. Install the strip holder into machine
- iii. Switch on the machine and wait the machine for initialization
- iv. Put the dry or calibrator strip on the strip holder till D sound
- v. Wait the machine to scan and print result
- vi. Record the QC result.

**Note: Return calibrator strip into its container and discard other used materials according to standard operating procedures**

### **5.3.12 Testing Procedures**

- i. Deep the reagent strips of G series into urine sample and put it on the dry gauze to remove excess urine on the back of the strip.
- ii. Put the sample strip on the strip holder till D sound
- iii. Read the patient result on the machine
- iv. Record result to the register

### **5.3.13 Biological Reference Intervals**

See annex 3.

### **5.3.14 Interpretation And Reporting Of Results**

Refer to the insert which present on the reagents strips of G series G10, G11, G14. Report result according to insert present on the reagent strip bottle

### **5.3.15 Limitation of the Procedure and Sources of Errors**

The test relies on correct collection of sample by the patient, and if this is not done properly the results may not be accurate

### **5.3.16 Performance Characteristics**

Refer to method verification

### **5.3.17 Supporting Documents**

URIT 50 user annual

### **5.3.18 References**

URIT 50 urine user manual.

## **5.4 PROCEDURE FOR (URIT-560) URINE ANALYZER**

### **5.4.1 Purpose**

This procedure provides instructions for determining urine biochemical test using the URIT-560 analyzer

### **5.4.2 Scope**

This procedure is used in Clinical chemistry section of the user when performing urine using the URIT-560 analyzer

### **5.4.3 Responsibility**

The section head of Clinical Chemistry is responsible for ensuring this procedure is effectively implemented and maintained

### **5.4.4 Principle**

The analyzer measures changes in reflectance of the reagent strips pads. A detector integrated in the system is composed of a light source and a light receiver, the light from which goes through spherical integrator and reflect at the reagent pads on the strips. The absorbance varies according to the color of the reagent pads. The darker the reagent pads is the higher the absorbance is and less light is reflected. Conversely, the lighter the reagent pad is the lower the absorbance is, and more light is reflected; ie. The degree of color development is proportion to the concentration of analyte in urine.

The reflected light goes in to the optical-electronic detector system, which transforms the optical into electrical. The strength of the electricity correlates which reflectance. Then the electrical cables will be processed by CPU after being transformed by I/V converter, and the test results can be printed out by printer.

### **5.4.5 Sample Requirements**

Dry, wide-necked, leak proof container 10-20 ml of urine sample.

### **5.4.6 Equipment**

URIT-560, Printer

### **5.4.7 Materials**

Urine strips (URIT G Series), Printer thermal paper, Urine container, Gloves

### **5.4.8 Storage and Stability**

Sample is stable for 2hrs at room temperature or 24hrs at 2-8°C

### **5.4.9 Safety**

- i. Personnel Protective Equipment must be worn at all times
- ii. Samples must be treated as potentially infectious.

### **5.4.10 Calibration**

Perform calibration as per manufacturer instructions

### **5.4.11 Quality Control**

Currently no control

#### **5.4.12 Procedural Steps.**

- i. Give the patient a sterile, dry, wide-necked, leak proof container and request 10-20 ml of urine sample.
- ii. Explain to the patient the need to collect the urine with as little contamination as possible i.e. a clean-catch sample.
- iii. On the instrument, press (image test) to enter into the image test interface.
- iv. Insert or Pour urine on the test strip, put test strip into test strip holder until the sound of alarm raised.
- v. Then wait the printer out results.

#### **5.4.13 Biological Reference Intervals.**

<b>Parameter</b>	<b>Abbreviation</b>	<b>Biological Reference Intervals</b>
Urobilinogen	URO	Normal
Glucose	GLU	Negative
Bilirubin	BIL	Negative
Ketones	KET	Negative
Specific gravity	S.G	1.003-1.029
Occult blood	BLD	Negative
Ph	Ph	4.5 - 7.8
Protein	PRO	Negative
Nitrite	NIT	Negative
Leukocytes	LEU	Negative

#### **5.4.14 Interpretation And Reporting Of Results**

Results are automatically printed from the machine. Attach results printout with report form

#### **5.4.15 Limitation of the Procedure and Sources of Errors.**

Urine must be processed within 2hr to avoid growth of bacteria which consuming glucose and developing ammonia in urine, loose of ketone bodies, Increase of PH

#### **5.4.16 Performance Characteristics**

Refer into method verification report

#### **5.4.17 Supporting Documents**

Equipment maintenance form, sample collection manual, quality manual

#### **5.4.18 References**

- URIT-560 operator's manual
- Standard guard line for Health Laboratory 2007 Edition.

## **5.5 PROCEDURE FOR PERFORMING URINE BIOCHEMISTRY BY USING CYBOW READER 300**

### **5.5.1 Purpose**

This Standard Operating Procedure (SOP) is aimed to describe step by step on how to operate the CYBOW™ **READER 300** semi-automated Urine analyser using Urine sample at the health facilities in Tanzania

### **5.5.2 Scope**

This procedure applies to all staff who works in parasitology section on performing urinalysis test.

### **5.5.3 Responsibility**

A trained, qualified and competent laboratory registered practitioner are responsible for performing this procedure. The head of sections is responsible for ensuring the implementation of this procedure.

### **5.5.4 Principle**

The **CYBOW** reader 300 are reflectance photometer. The strip is illuminated by white light, and the reflected light from the strip is detected by the sensor. The RGB signal is digitized, and this digitized image is interpreted by the processor. The intelligent image analyser SW locates the strip and the pads, and based on this colour data the parameter values are determined. The results including the date and the time of measurement, sequence number and the ID are stored printed out by the internal printer.

### **5.5.5 Sample Requirements**

10-20mls of mild stream urine sample collected in sterile wide mouth container is required for performing this test. **Do not** centrifuge urine sample before bio chemical test.

### **5.5.6 Equipment**

Perform the **CYBOW™ READER 300** procedure for start-up, maintenance, troubleshooting and shut down the urine analyser as per manufacturer's instrument instruction.

### **5.5.7 Materials/REAGENTS**

Gloves, Marker pen, Laboratory coat, Waste container, Gauze, Urine container and CYBOW strip.

### **5.5.8 Storage and Stability**

Sample, reagents, calibrators and control materials should be stored as per the manufacturer instructions.

### **5.5.9 Safety**

- Adhere to safety precautions as stated in the Safety manual

- All personal protective equipment (PPE) must be worn when performing this procedure.
- All samples must be regarded as potentially infectious.
- Front cover of machine should be covered during operation to avoid sample contamination.
- Used only power cord specified for CYBOW™ READER 300
- Avoid excessive dust, wet/damp condition and provide proper ventilation.
- Do not wipe the body clean with benzene, thinner, gasoline. This may discolour

#### **5.5.10 Calibration**

The calibration of instrument should be done prior to first time use and then the 2<sup>nd</sup> calibration process is recommended **in every 4 weeks** with calibration strip provided in the package.

#### **5.5.11 Quality Control**

Run internal Quality Control samples daily before examining patient samples to ensure quality of examination results. Other conditions that drive controls include:

- ✓ After a reagent lot number change
- ✓ After maintenance, component replacement, or a field service action
- ✓ After a software change
- ✓ Following calibration.
- ✓ According to regulatory requirements

#### **5.5.12 Procedural Steps**

- Check if the urine was received within 1 hour of collection and in a sterile universal container
- Mix the urine by swirling the container and dip a CYBOW strip into urine, making sure that the entire measuring region of the strip is immersed then running strip on instrument.

#### **Mode of running strip on CYBOW™ READER 300**

##### **1. General mode**

- Select the general mode by pressing direction key(◀) and press Enter button to return to the standby mode.
- After the 1<sup>st</sup> strip dipped in urine and placed on a plate, press start key(▶).
- Put 1<sup>st</sup>-10<sup>th</sup> (max.) strip on the plate one by one after dipping each in selected urine.
- Once last reagent strip on batch is placed, press Enter button
- After incubation time of the 1<sup>st</sup> strip, it will start to loading the results of the strip on by one.



## 2. One by one mode

- Select one by one mode by pressing **Direction** key (◀) and press **Enter** button.
- After the 1<sup>st</sup> strip is placed on the loading plate press **start** key (▶).
- Press direction key whenever each of the next strip is placed on the plate one by one.
- Once last strip is placed on strip loading plate, press **Enter** button.
- After incubation time of the 1<sup>st</sup> strip, it starts to read and print result of the strip one by one.

## 3. Quick mode

- Select the quick mode by pressing direction key (◀) and press **Enter** button
- Put the strips (incubation is done) once strip loading plate continuously.
- Once the last strip is placed on the loading plate, press **Enter** button.
- Test result is shown on the LCD and automatically saved in the memory

### **5.5.13 Biological Reference Intervals**

See annex 3.

### **5.5.14 Interpretation And Reporting Of Results**

#### **Chemical urinalysis**

Report the reading when the immersed strip is compared to the colours on the strips container

#### **Macroscopic examination**

Report whether the urine is Clear, Slightly cloudy, Cloudy or turbid. Report the colour of the urine which will range from Light yellow, Yellow, Amber, Red to Brown

#### **Microscopic examination of urine sediment**

- **White Blood Cells/Pus Cells/ leucocytes.**
- Report the average number of cells per High Power Field, example 2-5
- WBCs/HPF
- **Red Blood Cells**
- Report the average number of cells per High Power Field, example 2-5
- RBCs/HPF
- **Casts**
- Identify the type of cast and report as number per High Power Field
- **Crystals**
- Identify the type of crystals and report their presence
- **Epithelial cells**

- Identify the type whether squamous, transitional or renal epithelial cells, quantify them and report per high power field. Otherwise report the presence of epithelial cells if can't be identified.
- **Trichomonas Vaginalis**
- Report as "seen" or "not seen"
- **Yeast**
- Report as "seen" or "not seen"
- **Spermatozoa**  
Report for males and not for females

#### ***5.5.15 Limitation of the Procedure and Sources of Errors***

Urine samples should be tested within one hour of collection

If any delay happen put the urine sample in the refrigerator to avoid bacterial growth.

Do not use urine dipsticks beyond expiry date

#### ***5.5.16 Performance Characteristics***

Refer to the method verification report of this procedure

#### ***5.5.17 Supporting Documents***

Safety manual and Sample collection manual

#### ***5.5.18 References***

Manufacturer's Package Insert in multistrips kit

Cheesbrough, Monica Health Laboratory Manual for Tropical Countries

Graff's Text Book for Urinalysis and body fluids, Second edition, Lillian A. Mundt and Kristy Shanahan

## **5.6 PROCEDURE FOR DETERMINATION OF ALT BY USING DIRUI-DR 7000 CHEMISTRY ANALYZER**

### **5.6.1 Purpose**

This procedure provides instructions for determining Alanine Aminotransferase (ALT) using the DIRUI-DR7000 Analyzer

### **5.6.2 Scope**

This procedure is used in Clinical chemistry section for analysing ALT using the DIRUI-DR7000 clinical chemistry Analyzer.

### **5.6.3 Responsible personnel**

Qualified, trained and competent Health Laboratory practitioners are responsible for performing this procedure. Section heads and quality manager/officer are responsible for ensuring this procedure is effectively implemented and maintained.

### **5.6.4 Principle**

Kinetic method for the determination of ALT activity according to the recommendations of the Expert Panel of the International Federation of Clinical Chemistry (IFCC). Without pyridoxalphosphate activation. ALT is measured by the reagent rate analysis by the coupled reaction with lactate dehydrogenase (LDH) to reduce NADH (measured at a wavelength of 340nm) to NAD<sup>+</sup>. The rate of decrease in absorbance at 340 nm due to NADH depletion is proportional to the ALT activity in the sample.

### **5.6.5 Sample requirement**

30µl serum or plasma, sample free from hemolysis.

### **5.6.6 Equipment**

DIRUI DR7000 Semi Automated Chemistry Analyzer, Centrifuge machine

### **5.6.7 Materials**

Reagent Kits, Calibrator/Standard, Control Kits (LEVEL I and II), Disposable gloves Laboratory coat, Sample Cups, Reaction Wells, Transfer Pipettes

### **5.6.8 Storage and stability**

Refer to the facility laboratory sample collection manual

### **5.6.9 Safety**

- i. Adhere to safety precautions as stated in the facility laboratory Safety manual/IPC guideline
- ii. All personal protective equipment (PPE) must be worn when performing this procedure.
- iii. All samples must be regarded as potentially infectious.

### **5.6.10 Calibration**

- i. Perform equipment calibration when; -
- ii. There is a change in the reagent lot number.
- iii. If the QC result falls outside the acceptable ranges.
- iv. The machine blinks on the QC-calibration indicating that the calibration is expired.
- v. There is a change in the system software
- vi. System maintenance/ component replacement procedure is performed

### **5.6.11 Quality Control**

QC should be performed before patient samples, after calibration of reagent

### **5.6.12 Procedure Steps**

#### **Running the Calibrator, controls or samples;**

- i. Label the tubes for blank, calibrator, Controls or samples
- ii. Prepare the working reagents as indicated by the industrial manufacturer
- iii. Pipette the working reagents R1 480µl into the labelled tubes
- iv. Pipette 30µl of distilled water into the tube labelled blank.
- v. Incubate for 300s
- vi. Add 120µl of R2 reagent
- vii. Incubate for 60s
- viii. Read the result

### **5.6.13 Biological Reference Intervals**

See annex 4.

### **5.6.14 Interpretation and Reporting of Results**

#### **Interpretation of results**

Performed results will be displayed on the machine screen

#### **Result reporting**

Once all of the results are accepted or validated, a final report will automatically be printed out.

### **5.6.15 Limitation of the Procedure and Sources of Error**

Use of hemolyzed, lipemic samples, icterus and anticoagulants such as citrate, oxalate and fluoride

### **5.6.16 Performance Characteristics**

Refer to the verification report

### **5.6.17 Supporting Document**

Sample collection manual, quality manual

### **5.6.18 References**

DIRUI-DR7000 Chemistry analyser user manual

## **5.7 PROCEDURE FOR DETERMINATION OF AST BY USING DIRUI-DR7000 CHEMISTRY ANALYZER**

### **5.7.1 Purpose**

This procedure provides instructions for determining ASAT using the DIRUI-DR7000 Analyzer

### **5.7.2 Scope**

This procedure is used in Clinical chemistry section of the user when performing blood analysis using the DIRUI-DR7000 clinical chemistry Analyzer

### **5.7.3 Responsibility**

The section head of Clinical Chemistry is responsible for ensuring this procedure is effectively implemented and maintained.

### **5.7.4 Principle**

Kinetic method for the determination of Aspartat-Aminotransferase (AST) activity according to the recommendations of the Expert Panel of the International Federation of Clinical Chemistry (IFCC). Without pyridoxalphosphate activation. AST is measured by the reagent rate analysis by the coupled reaction with Malate dehydrogenase (MDH) to reduce NADH (measured at a wavelength of 340nm) to NAD<sup>+</sup>. The rate of decrease in absorbance at 340 nm due to NADH depletion is proportional to the AST activity in the sample.

### **5.7.5 Sample Requirements**

Serum or plasma, sample free from hemolysis and not contaminated

### **5.7.6 Equipment**

DIRUI DR7000 Semi Automated Chemisry Analyzer•

#### **Cleaning and Maintenance**

- i. Use a large amount of distilled water to rinse the tubing by click the rinse interface.
- ii. And drain the liquid from the tubing if necessary.
- iii. Remove the waste liquid bottle from the back of the analyzer.
- iv. Keep the instrument vertical during move and transport.
- v. Try best to avoid vibration.
- vi. And check and debug the instrument before use.

### **5.7.7 Materials**

Reagent Kits, Calibrator/Standard,Control Kits (LEVEL I and II), Supplies, Disposable gloves, Laboratory coat, Sample Cups, Reaction Wells and Transfer Pipettes

### **5.7.8 Storage and Stability**

- Reagent Should be kept at temperature of 2-8°C and sealed in dry place without sunshine. The shelf life is 18 months .
- Under condition of 2-8°C, the open vial stability is 30 days

### **5.7.9 Safety**

Personnel Protective Equipment must be worn at all times and samples must be treated as potentially infectious.

### **5.7.10 Calibration**

It is suggested to use supplementary calibrator as instructed. When lot number is changed or QC is invalid, calibration shall be conducted again.

Procedures for reagent, Calibration, QC and Sample preparation

### **5.7.11 Quality Control**

It is suggested to use QC products produced by DIRUI.

### **5.7.12 Procedural steps**

- i. Label the tubes for blank, calibrator, Controls or samples
- ii. Prepare the working reagents as indicated by the industrial manufacturer
- iii. Pipette the working reagents R1 480µl into the labelled tubes
- iv. Pipette 30µl of distilled water into the tube labelled blank.
- v. Incubate for 300s
- vi. Add 120µl of R2 reagent
- vii. Incubate for 60s
- viii. Read the results

### **5.7.13 Biological Reference Intervals.**

See annex 4.

### **5.7.14 Interpretation and Reporting of Results**

#### **Reporting of results**

Results are automatically printed from the machine

Attach results printout with report form.

### **5.7.15 Limitations of the procedure and sources of error.**

Gross hemolysis, Lipemic AND Icterus sample

### **5.7.16 Performance Characteristics**

Refer verification report

### **5.7.17 Supporting Documents**

Equipment Maintenance Form.

## **18.0 References**

DIRUI DR7000 Analyser operator's manual

National standard guard line for Health Laboratory 2007 Edition

## **5.8 PROCEDURE FOR SA-30 SEMI AUTOMATED CHEMISTRY ANALYZER**

### **5.8.1 Purpose**

This Procedure describes step by step on how to operate the SA-30 a semi-automated chemistry analyser to perform basic chemistry tests using human serum, plasma or cerebral spinal fluid (CSF) sample.

### **5.8.2 Scope**

it is applied in testing biochemistry parameters using human serum or plasma sample in the biochemistry department/section.

### **5.8.3 Responsibility**

All qualified, trained and competent laboratory scientist, laboratory technologists and assistant laboratory technologists are responsible for performing this procedure.

The head of section of biochemistry is responsible of ensuring the implementation of this procedure.

### **5.8.4 Principle**

The principle of the instrument is based on the phenomenon of different wave band absorbance from substance, which is in line with Lambert-Bill Law.

(The greater the concentration of the sample, the more light is absorbed, the less light is transmitted, and the darker of the color)

### **5.8.5 Sample Requirements**

The 2 - 4ml of whole blood collected in plain tube (red top) for serum or EDTA (purple top) for plasma or in heparinized tube free from hemolysis. Cerebral spinal fluid (CSF) when required.

### **5.8.6 Equipment**

SA-30 semi- automated chemistry analyser, Centrifuge

### **5.8.7 Materials**

Micropipettes and tips, Marker pen, Thermal paper and PPE

### **5.8.8 Storage and Stability**

- i. Store serum/plasma at room temperature 25 – 35 °C for 8 hours
- ii. Tested sample stored at 2 -8 °C to 7 days.
- iii. Store reagent,calibrator and controls per manufacture recommendation

### **5.8.9 Safety**

Treat all Samples and control materials as infectious material and should be handled careful as per IPC guidelines

### **5.8.10 Calibration**

Quality Control procedure is the same as analytic procedure of unknown sample

(Use Randox Calibrator (pipette 500µl of reagent to tube and add 25µl calibrator mix gently and incubate at 37°C for 8-10 minutes for end point test method, no need of extra incubation for kinetics method)

#### **5.8.11 Quality Control**

Quality Control procedure is the same as analytic procedure of unknown sample (Use Randox QC ,pipette 500µl of reagent to tube and add 25µl control mix gently and incubate at 37C for 8- 10 minutes end point test method, no need of extra incubation for kinetics test method)

#### **5.8.12 Procedural Steps**

- i. Prepare for sample and reagent.
- ii. For End point test method, Add R1 + R2 + Sample in ratio and mix thoroughly and incubate at 37°C for 8 – 10 Min (refer to reagent user manual)
- iii. For kinetics test method, Add R1 + R2 + Sample in ratio and mix thoroughly, no need of extra incubation.
- iv. For HDL, LDL add R1 + Sample in in ratio, mix them thoroughly incubate at 37°C in 2 min then add R2 and incubated them in 5-7 Min,
- v. Click “Test” on main menu to enters next page to start testing.
- vi. Press PUSH button to aspirate distilled water, to calibrate AD value. The AD value should be 45000 to 60000.
- vii. Click “Continue” to test reagent blank.
- viii. Select “YES” to aspirate reagent blank to test reagent blank absorbance.
- ix. Press PUSH button to aspirate reagent blank to test reagent blank absorbance.
- x. Click “Continue” to test STD
- xi. Select “NO”, device will use last factor and perform the sample test directly. Select “YES”, device will aspirate standard to test STD
- xii. Press PUSH button to aspirate standard, then device will test standard absorbance and calculate factor automatically
- xiii. Click “Continue” to next to test the sample directly or perform control test.
- xiv. Press PUSH button to aspirate sample or control, then device will test the sample or control and display test result automatically

#### **5.8.13 Biological Reference Intervals**

See annex 4.

#### **5.8.14 Interpretation And Reporting Of Results**

- **Interpretation**

- i. If the result of the particular parameter lies within the established reference range, it means that the patient has normal particular parameter.
- ii. If the result of the particular parameter lies below or above the established reference range, it means that the patient has abnormal



particular parameter and requires intervention as per the clinical history and the laboratory findings.

- **Reporting results**

Report the results as they are displayed on the screen of the machine

#### **5.8.15 Limitation of the Procedure and Sources of Errors**

- i. Avoid using the haemolysed and lipemic sample as this will cause falsely elevated values. In this case inform the requesting physician and ask for another sample.
- ii. Avoid exposure of the freshly dissolved substrate to strong sunlight, since the reagent is light sensitive. The change in absorbance will increase with an increase in temperature, since the pH of the reagent will be different at different temperatures
- iii. Serum must be separated by centrifugation as soon as possible after collection of the patient's blood sample, preferably <2 hours, otherwise, phosphate present in erythrocytes will be released into the serum causing falsely elevated values
- iv. Grossly bloody CSF may give spuriously elevated values. Undue delay in analysis may give low values. The report to the requesting physician should include the appearance of the CSF before and after centrifugation.

#### **5.8.16 Performance Characteristics**

Refer to method verification report

#### **5.8.17 Supporting Documents**

Sample collection manual, Safety manual, Quality manual

#### **5.8.18 References**

SA-30 semi automated chemistry analyser user manual

## **5.9 PROCEDURE FOR OPERATING CLINDIAG FA 200 CHEMISTRY TEST**

### **5.9.1 Purpose**

This procedure provides instructions for determining basic Chemistry tests using Clindiaq FA 200 analyzer.

### **5.9.2 Scope**

This procedure is used at Clinical chemistry section for processing basic chemistry tests using Clindiaq FA 200 analyzer.

### **5.9.3 Responsibility**

Qualified and trained Health Laboratory Personnel are responsible for doing this test procedure.

### **5.9.4 Principle**

The test principle of the biochemistry analyser is mainly based on the Lambert Beer law.

The reagents and the samples to be tested are mixed at a certain proportion. The mixture is placed in a calorimetric dish at a certain temperature for incubation, its absorption of light of specific wavelength is continuously measured, and finally the concentration of the measured substance is automatically calculated according to the value of absorbance (change). The procedure uses **Lambert Beers Law** which states that the absorptive capacity of a dissolved substance is directly proportional to its concentration in the solution.

### **5.9.5 Sample Requirements**

Serum is the most preferred sample.

Refer to the facility Laboratory sample collection manual.

### **5.9.6 Equipment**

Clindiaq FA200 Chemistry analyser.

### **5.9.7 Materials**

Reagent kits, cleaning solution, HD- high efficiency cleaning agent, Sample cups, Calibrators and controls, Gloves, Laboratory coat, A4 paper, Micropipette, Micropipette tips

### **5.9.8 Storage and Stability**

Samples are stored at 2-8°C after testing for 3 days.

### **5.9.9 Safety**

- i. Adhere to safety precautions as stated in the Safety manual.
- ii. All personal protective equipment (PPE) must be worn when performing this procedure.
- iii. All samples must be regarded as potentially infectious.
- iv. Refer to National infection prevention and control Guidelines for health care.

- v. Avoid any contact between hands and eyes and nose during sample collection and testing.
- vi. Do not use kit beyond the expiration date.
- vii. Do not reuse the test device.
- viii. All spills should be wiped thoroughly using 1% sodium hypochlorite solution.

#### **5.9.10 Calibration**

Machine should be calibrated when

- There is a change in the reagent lot number.
- If the QC result falls outside the acceptable ranges.
- There is a change in the system software
- System maintenance/ component replacement procedure is performed

#### **5.9.11 Quality Control**

**Follow the following steps to run internal quality control**

- i. Click on task.
- ii. Click on add Quality control(QC.)
- iii. Click on ADD
- iv. Select QC batch number.
- v. Select a QC item in QC list
- vi. Select type of container
- vii. Input the position of QC material on the sample plate
- viii. Click on OK
- ix. Allow the machine to perform test till final results

#### **5.9.12 Procedural Steps**

- i. Click Task
- ii. Click Add sample
- iii. Click ADD
- iv. Enter patient information
- v. Select the test item
- vi. Select the sample cup number
- vii. Click OK
- viii. Click Test on left side
- ix. Select test sample
- x. Then click start test
- xi. When sample processing is complete, Select the results from the menu bar, patient result review will display, select name of patient on the left side.
- xii. All the undone tests will be shown on the results as NA with a reason on the right side.
- xiii. Re-running patient sample, repeat the patient order with no change in a sample cup number

#### **5.9.13 Biological Reference Intervals**

See annex 4.

#### **5.9.14 Interpretation And Reporting Of Results**

##### **Results interpretation**

Click on <Results> then <sample Results>. The results appear on the computer screen, from here you can select the desired results and release them.

##### **Reporting of the results**

To print the results, select the sample interface in browse result and click print the test results. Results.

- **Critical results**

Critical results should be immediately communicated to the clinicians requested the examination. Refer to the annex .... For more details on critical results for clinical chemistry assays.

#### **5.9.15 Limitation of the Procedure and Sources of Errors**

Do not process hemolysed samples as they might lead to falsely high results of potassium and low results for glucose.

Samples for glucose investigation should be processed within 2 hours of collection; any delay would cause falsely low results.

Potential operator errors and Clindiaq FA 200 system technology limitations.

Communicate the following Panic/Critical values to the clinicians

#### **5.9.16 Performance Characteristics**

Method verification of this procedure should be done and that the report should be referred to verify compliance to this requirement.

#### **5.9.17 Supporting Documents**

Sample collection manual

#### **5.9.18 References**

Refer to equipment instruction manual Clindiaq FA 200

## **5.10 PROCEDURE FOR DETERMINATION OF IMMUNOASSAYS BY USING GETEIN 1100 IMMUNOANALYSER**

### **5.10.1 Purpose**

This procedure provides description on determination of immunoassays by using Getein 1100 Immunofluorescence Quantitative analyser.

### **5.10.2 Scope**

This procedure is used for processing and analysis of immunol assay tests in the biochemistry department/section at the hospital laboratory.

### **5.10.3 Responsibility**

A qualified, trained and competent laboratory scientist, laboratory technologists and assistant laboratory technologists are responsible for performing this procedure. The head of section of biochemistry is responsible of ensuring the implementation of this procedure.

### **5.10.4 Principle**

The detection element scans the binding area and converts the optical signal to electrical signal. The voltage variation between the test line and background has a linear relationship with the antigen concentration which can be used to calculate the concentration. In conclusion the antigen concentration in whole blood, plasma, serum, urine can be calculated quantitatively according to optical signal of the test line.

### **5.10.5 Sample Requirements**

The 2 - 4ml of whole blood collected in plain tube (red top) for serum or EDTA (purple top) for plasma or in heparinized tube free from hemolysis.  
urine sample will be collected in urine container if required.

### **5.10.6 Equipment**

Getein1100 Immunofluorescence Analyzer, stop watch

### **5.10.7 Materials**

Disposable gloves, Micropipettes and its tips, Containers for waste segregation, Marker pen, Getein test card

### **5.10.8 Storage and Stability**

Store unprocessed samples at room temperature for 12 hours. Store performed samples at 2 - 8°C up to 7 days.

Calibrator, controls and test kit devices should be stored as per manufactures instruction

### **5.10.9 Safety**

- i. Samples and control materials should be treated as infectious material
- ii. Worn PPE all of the time while working

### **5.10.10 Calibration**

Calibration of the assay should be performed as per manufacturer instruction.

#### **5.10.11 Quality Control**

Use commercial available controls or inhouse controls to run QC as per schedule

#### **5.10.12 Procedural Steps**

- i. Refer to the user manual or material data sheet to specific items including reaction time and sample volume carefully for accurate information
- ii. Add patient information including ID, name, age, gender, types of sample and test mode to be used
- iii. Click start after inserting the card, test item will be auto-recognized and the result will be shown on the screen. User can also see the voltage waveform by slide to the left side
- iv. Normally, the test card will auto-quit after testing if not please click on “Quit” icon to quit manually

#### **5.10.13 Biological Reference Intervals**

See annex 4.

#### **5.10.14 Interpretation and Reporting of Results**

##### **Interpretation of results**

If the result of the particular parameter lie within established reference range, it means that the patient has normal particular parameter.

If the results of the particular parameter lie below or above established reference range, it means that the patient has abnormal particular parameter and requires intervention as per the clinical history and the laboratory finding.

##### **Reporting of results**

Report the result as they are displayed on the screen of the machine.

#### **5.10.15 Limitation of the Procedure and Sources of Errors**

Only used for in vitro analysis of human whole blood, serum, plasma, urine or stool frozen samples can not be used for testing due to loss of enzyme or hormone activities

#### **5.10.16 Performance Characteristics**

Refer to verification report.

#### **5.10.17 Supporting Documents**

- Sample collection manual
- Material data sheet or reagent manual
- Safety manual

#### **5.10.18 References**

Getein 1100 user manual

## **5.11 PROCEDURE FOR OPERATING FIA 8000 ANALYSER**

### **5.11.1 Purpose**

This procedure provides instructions for operating FIA 8000 Quantitative Immunoassay Analyzer for biomarkers.

### **5.11.2 Scope**

This FIA8000 is an analyzer that used to measure biomarkers in human whole blood, serum, plasma or urine samples.

### **5.11.3 Responsibility**

Qualified and competent registered Health Laboratory practitioners are responsible for doing this test procedure. The head of section of chemistry is responsible for ensuring the effective implementation and competency assessment for this procedure.

### **5.11.4 Principle**

The combination of the antigen in the sample, the gold-label antibody in the colloidal gold pad or nitrocellulose membrane, and the antibody pre-coated on the test line can form a purplish red streak on the test line. The colour intensity of the test line is proportionate to the quantity of antigens detected in the sample. The analyser system can obtain the photo-electric signal intensity of the complex by scanning the test line with a photo-electric component. Then the voltage difference between the voltage of the test line and the background is obtained. The voltage difference has a linear relationship with the antigen concentration which can be used to calculate the antigen concentration. The relationship has been established and varying from the measured parameter. In conclusion, the antigen concentration in whole blood, plasma, serum, urine can be calculated quantitatively in one-step according to the colour intensity of the test line.

### **5.11.5 Sample Requirements**

Centrifuged Serum and plasma

### **5.11.6 Equipment**

FIA 8000 Quantitative Immunoassay Analyzer

### **5.11.7 Materials**

Test kit, Power source, Printing paper, QC Card, QC SD, Gloves

### **5.11.8 Storage and Stability**

Fresh sample is preferred however if can not be done sample can be stored at 2-8°C not more than 3 days.

### **5.11.9 Safety**

- i. Decontaminate working surfaces twice daily, in the morning and afternoon
- ii. Adhere to safety precautions as stated in the Safety manual
- iii. All personal protective equipment (PPE) must be worn when performing this procedure.

- iv. All samples must be regarded as potentially infectious.
- v. Avoid any contact between hands and eyes and nose during sample collection and testing.
- vi. All spills should be wiped thoroughly using 1% sodium hypochlorite solution
- vii. Decontaminate the biohazard waste before disposal.

#### **5.11.10 Calibration**

**Perform equipment calibration when; -**

- i. There is a change in the reagent lot number.
- ii. If the QC result falls outside the acceptable ranges.
- iii. The machine blinks on the QC-calibration indicating that the calibration is expired.
- iv. There is a change in the system software
- v. System maintenance/ component replacement procedure is performed

#### **5.11.11 Quality Control**

Quality Control (QC) card should be run before processing patient sample for each day

#### **5.11.12 Procedural Steps**

- i. Centrifuge collected whole blood samples to obtain serum or plasma.
- ii. Mix urine samples thoroughly before testing.
- iii. Allow samples to reach room temperature before testing.
- iv. Turn on the analyser and select the test.
- v. Touch the screen to turn on the analyzer.
- vi. Select the test you want to perform from the list of available tests.
- vii. Insert the test card.
- viii. Open the test card slot.
- ix. Carefully insert the test card into the slot, making sure that the arrows on the test card are pointing in the same direction as the arrows on the analyzer.
- x. Close the test card slot.
- xi. Add the sample.
- xii. Follow the on-screen instructions to add the sample to the test card. Be careful not to overfill the sample well.
- xiii. Touch the screen to start the test.
- xiv. The analyzer will automatically begin to process the sample.
- xv. Read the results.
- xvi. The analyzer will automatically read the results and display them on the screen.
- xvii. The results may be displayed in a variety of formats, such as quantitative results, qualitative results, or graphs.

#### **5.11.13 Biological Reference Intervals**

See annex 4.



#### **5.11.14 Interpretation And Reporting Of Results**

##### **Interpretation of results**

Interpretate results based on the Biological reference interval.

Normal results are patient results which fall within the reference range for the particular test. Abnormal results are those that fall below or above the reference range. The test report is labeled H: High and L: Low to show the abnormality obtained.

##### **Reporting of results**

Report the obtained and displayed results in request form/register

##### **Critical results**

See annex 5.

#### **5.11.15 Limitation of the Procedure and Sources of Errors**

Haemolyzed sample should not be used since the color changes caused by haemolysis may result to wrong results. Refer to package insert for interfering substances for specific test

#### **5.11.16 Performance Characteristics**

Refer to the method verification report.

#### **5.11.17 Supporting Documents**

Sample collection manual

#### **5.11.18 References**

User manual for FIA 8000 Analyser.

## **5.12 PROCEDURE FOR OPERATING ALERE AFFINION AS100ANALYSER**

### **5.12.1 Purpose**

The purpose of this procedure is to provide instructions on how to operate ALERE AFFINION AS100 analyser for HbA1c, Lipid panel and C - reactive protein.

### **5.12.2 Scope**

- This procedure is used in Clinical chemistry section for processing HbA1c,Lipid panel and C-Reactive Protein.

### **5.12.3 Responsibility**

- A trained, qualified and competent laboratory registered practitioners are responsible for performing this procedure. The head of section for chemistry is responsible for ensuring the effective implementation and competency assessment for this procedure

### **5.12.4 Principle**

A Test Cartridge with patient sample or control is placed in the cartridge chamber of the Analyzer. By manually closing the lid, the Test Cartridge is transported into the analysis compartment of the Analyzer. Test and lot-specific information is obtained from the barcode label (Figure 2). When the Test Cartridge enters the Analyzer, the integrated camera reads the barcode. The calibration data for the actual lot are read, which then initiates the processing of the Test Cartridge. The sample and reagents are automatically transferred between the wells. An integrated camera monitors the entire process. Light-emitting diodes (LEDs) illuminate the reaction area, which can be either a colored membrane or a reaction well. The camera detects the reflected or transmitted light, which is converted to a test result and displayed on the touch screen. When the user accepts the result, the lid covering the cartridge chamber opens automatically and the used Test Cartridge can be removed and discarded. The Analyzer is then ready for the next run.

### **5.12.5 Sample Requirements**

- Whole blood/Serum / plasma as specified in the reagents insert or as stated in the sample collection manual.

### **5.12.6 Equipment**

Alere Affinion AS100

### **5.12.7 Materials**

Test cartridge, Calibrators, Controls, PPEs, Pipette tips 100 -200ul, Pipette tips 100, 1000ul, Sample container rack, waste bin

### **5.12.8 Storage and Stability**

- Test cartridge should be stored in refrigerator at 2-8°C in sealed foil pouches and only stable until expiration date. If not refrigerated they can be stored at room temperature(15-25°C) for four weeks.

- Test cartridges should not be exposed to direct sunlight at relative humidity below 90%.
- Whole blood samples can be stored refrigerate at 2-8° C for 3 days. Plasma and serum samples can be refrigerated for 10 days or frozen up 1 year if the tubes are properly sealed.

### 5.12.9 Safety

- Adhere to safety precautions as stated in the Safety manual/IPC guideline
- All personal protective equipment (PPE) must be worn when performing this procedure.
- All samples must be regarded as potentially infections.

### 5.12.10 Calibration





Perform calibration as per Alere Afinion™ AS100 user manual.









### 5.12.11 Quality Control

Quality control should be done as prescribed in the quality management procedure. Use commercial or in-house made quality control materials to perform on daily basis before testing patient samples. Commercially available quality materials should be used to verify performance of the procedure at least after 100 patient samples have been tested. Lot to lot verification should also be used to check performance acceptability of reagents.

### 5.12.12 Procedural Steps

Analyzing a patient/control sample

1		<p>Touch  to enter the patient sample mode.          Touch  to enter the control mode. A “C” in the upper left corner indicates that the Analyzer is in the control mode. The lid opens automatically.  <i>If the lid is left open from the previous run and “Insert Cartridge” is displayed, this step is omitted and you can start with step 2.</i></p>
2		<p>Insert the Test Cartridge with the barcode label facing left.  <i>Be sure that the Test Cartridge is correctly placed in the cartridge chamber.</i></p>
3		<p>Close the lid manually. The Analyzer will start processing the Test Cartridge.  <i>The processing time depends on the test in use.</i></p>

4		<p>Touch  and enter the patient ID.  Touch  to confirm.  Touch  and enter the control ID or Alere Afinion™ Control Data. Touch  to confirm.  <i>Entering the patient ID, control ID or Alere Afinion™ Control Data will not interrupt the processing.</i></p>
5		<p>Record the result, then touch  to accept.  If a printer is connected, touch  to print the result.  The lid opens automatically.  <i>The result will be saved in the result records.</i></p>
6		<p>Remove the used Test Cartridge from the cartridge chamber and discard it in a suitable waste container. Insert a new Test Cartridge or close the lid manually.  <i>Keep the lid closed to protect the cartridge chamber when the Analyzer is not in use.</i></p>

### 5.12.13 Biological References

See annex 4.

### 5.12.14 Interpretation And Reporting Of Results

#### Interpretation of results

- Interpretation of results is based on the Biological reference interval;
- Normal results are patient results which fall within the reference range for the particular test.
- Abnormal results are those that fall below or above the reference range.

#### Reporting of Results

Report the displayed/printed results into register/request form

### 5.12.15 Limitation of the Procedure and Sources of Error

- i. Icteric samples that appears with yellow colour of the serum or plasma due to bilirubin accumulation.
- ii. Samples tested after 24 hours may give unreliable results Avoid using lipemic samples

### 5.12.16 Performance Characteristics

Refer the method verification reports .

### 5.12.17 Supporting Document

- i. Sample Collection Manual, Safety Manual, Quality Manual

### 5.12.18 References

ALERE AFFINION AS100analyzer user manual  
Manufacturer package insert

## **5.13 PROCEDURE FOR OPERATING ST-200 ABG ANALYZER Purpose**

### **5.13.1 Purpose**

The purpose of this procedure is to provide detailed instructions on how to operate the ABG ST-200 analyser for the provision of the arterial blood gases.

### **5.13.2 Scope**

This procedure applies to all ST-200 arterial analyzers used to analyze arterial blood samples..

### **5.13.3 Responsible personnel**

Qualified and competent registered Health Laboratory practitioners are responsible for doing this test procedure.

The head of unit Clinical Chemistry is responsible for ensuring the effective implementation and competency assessment for this procedure

### **5.13.4 Principle**

Blood gas analyser uses **Ion Selective Electrodes (Direct potentiometry)** to determine PH, partial pressure of oxygen and carbon dioxide in the blood and electrolytes. The analyser aspirates the blood into the measuring chamber which has ion selective electrodes that are sensitive only to the measurement of interest. **For blood PH:** The PH electrode compares a potential developed at the electrode tip with reference potential, the resulting voltage is proportional to the concentration of hydrogens ions [H<sup>+</sup>]. **For partial pressure of carbon dioxide [PaCO<sub>2</sub>]:** The partial pressure of carbon dioxide electrode is a PH electrode with silicon rubber CO<sub>2</sub> semi permeable membrane covering the tip. CO<sub>2</sub> combines with H<sub>2</sub>O in the space between the membrane and the electrode tip to produce free ions in proportional to the partial pressure of CO<sub>2</sub>. **For partial pressure of oxygen [O<sub>2</sub>]** Oxygen permeates a polypropylene membrane and reacts chemically with a phosphate buffer. The O<sub>2</sub> combines with water in the buffer, producing current in proportional to the number of oxygen molecules. The current is measured and expressed as partial pressure of oxygen.

### **5.13.5 Sample requirements**

2-5mls of venipuncture blood collected in either plain vacutainer (red top) or vacutainer with lithium-heparin (green top).

EDTA for glycated Haemoglobin ,sample should be brought at the laboratory within two hours after collection of whole blood

Sample should be free from haemolysis

### **5.13.6 Equipment**

ST-200 Arterial blood Analyze.

Maintenance and other trouble shooting should be performed as per manufacturer's instructions

### **5.13.7 Materials**

Reagent kits, Waste container, cuvettes, Gloves, 70% alcohol solution in alcohol bottle, 0.5% sodium hypochlorite solution, Sharp safety box, Sample container rack and Waste bin

### **5.13.8 Storage and stability**

A blood sample can be stored for up to 3.5 hours in an ice-water bath without significant change in pH and for 6 hours without significant change in PCO<sub>2</sub> or PO<sub>2</sub>.

### **5.13.9 Safety**

- i. Adhere to safety precautions as stated in the Safety manual/IPC guideline
- ii. All personal protective equipment (PPE) must be worn when performing this procedure.
- iii. All samples must be regarded as potentially infectious.

### **5.13.10 Equipment calibration**

Perform calibration as per ABG ST-200 operator user manual. Run the internal quality control samples to verify the performance of the machine

### **5.13.11 Quality Control**

Use commercial or in-house made Quality control materials to perform on daily basis before testing patient samples or:

- i. After a reagent lot number change
- ii. After maintenance, component replacement, or a field service action
- iii. After a software change
- iv. Following calibration.

### **5.13.12 Procedure Steps**

- i. Enter the sample definition parameters which include options like the sample ID.
- ii. Select the test to be performed on the patient sample by simply selecting them in the test definition section then save the selected tests.
- iii. Insert the syringe containing heparinized sample to the probe or cuvette containing heparinized sample.

### **5.13.13 Biological Reference Interval**

Analytes	Biological reference interval
PH	7.37-7.49
PaCO <sub>2</sub>	4.84-7.20 kPa (36.3-54.0 mmHg)
PaO <sub>2</sub>	11.01-14.97 kPa (82.6-112.3 mmHg)
Na <sup>+</sup>	133-141 mmol L <sup>-1</sup>
K <sup>+</sup>	3.05-4.65 mmol L <sup>-1</sup>
Ca <sup>2+</sup>	1.34-1.72 mmol L <sup>-1</sup>
Cl <sup>-</sup> ,	100-110 mmol L <sup>-1</sup>

HCO <sub>3</sub> <sup>-</sup> (P)	23.55-33.90 mmol L <sup>-1</sup>
HCO <sub>3</sub> <sup>-</sup>	(P, st), 23.87-32.45 mmol L <sup>-1</sup>

#### 5.13.14 Interpretation And Reporting Of Results

##### Interpretation of results

- Normal results are patient results which fall within the reference range for the particular test.
  - Abnormal results are results which falls above or below the reference ranges
- The following information shows the changes in PH, CO<sub>2</sub> and bicarbonates concentration in different situations.
- **Metabolic acidosis:**
    - ✓ PH ↓, PCO<sub>2</sub> ↔, Bicarbonate ↓
  - **Respiratory acidosis**
    - ✓ PH ↓, PCO<sub>2</sub> ↑, Bicarbonate ↔
  - **Metabolic alkalosis:**
    - ✓ PH ↑, PCO<sub>2</sub> ↔, Bicarbonate ↑
  - **Respiratory alkalosis:**
    - ✓ PH ↑, PCO<sub>2</sub> ↓, bicarbonates ↔

##### Reporting of results

Review and report the displayed patient results on either reister/request forms or LIS

#### 5.13.15 Limitation of the Procedure and Sources of Error

- Clinical chemistry tests will be affected by hemolysis, lipemia, icterus and anticoagulants such as citrate, oxalate and fluoride (for other tests except Glucose) and drugs such as hydroxocobalamin and Cephalosporin antibiotics.
- Never process the sample which stays more than one hour before separation of serum/plasma and blood cell

#### 5.13.16 Perfomance characteristics

Refer to the facility laboratory verification report

#### 5.13.17 Supporting document

Sample collection manual, Safety manual, Laboratory quality manual,

#### 5.13.18 References

- i. ST-200 ABG Analyzer user manual.
- ii. Hughes J, Bardell D Determination of reference intervals for equine arterial blood-gas, acid-base and electrolyte analysis, *Veterinary Anaesthesia and Analgesia*
- iii. <https://doi.org/10.1016/j.vaa.2019.04.015>

## 5.14 PROCEDURE FOR OPERATING HUMASTAR 600

### 5.14.1 Purpose

The purpose of this procedure is to provide detailed instructions on how to operate the Human star 600 for the provision of the Clinical Chemistry results.

### 5.14.2 Scope

This document applies to staff in Clinical Chemistry Section of the laboratory Department.

### 5.14.3 Responsibility

Qualified and competent registered Health Laboratory practitioners are responsible for doing this test procedure.

The head of section of chemistry is responsible for ensuring the effective implementation and competency assessment for this procedure.

### 5.14.4 Principle

Ion Selective Electrode (ISE) module operates with direct measurement of electrolytes through membrane ion selective electrodes. Electrodes operate upon selective electrolyte detection *properties* of membrane electrolyte filled sensors. A potential is developed, referred to the reference electrode, at the ion selective membrane. This is done by means of the Ion selective membrane which develops a potential with respect to reference electrode.

### 5.14.5 Sample Requirements

Sample volume should be 2mls for serum/plasma or 5mls of venipuncture blood. Serum collected in standard tubes or Plasma that collected into the Heparin, EDTA tube. Sample should be free from haemolysis.

### 5.14.6 Equipment

Human star 600 Analyzer

### 5.14.7 Materials

Reagent	Consumables
Reagent kits (for all except immunoassay tests done by the Snibe analyser at BMH) AUTOCAL (Calibrators for Automated systems) for all tests.	Examination gloves Cuvette clean Sample cups Reaction cuvettes

### 5.14.8 Storage and Stability

Retain the processed sample at 2 – 8°C for 7 days

### 5.14.9 Safety

- i. Decontaminate working surfaces twice daily in the morning and afternoon
- ii. Adhere to safety precautions as stated in facility laboratory Safety manual
- iii. All personal protective equipment (PPE) must be worn when performing this procedure.



- iv. All samples must be regarded as potentially infectious.
- v. Avoid any contact between hands and eyes and nose during sample collection and testing.
- vi. All spills should be wiped thoroughly using 1% sodium hypochlorite solution.

#### **5.14.10 Calibration**

Calibration is done under the following conditions;

- vii. Conduct After major repairs
- viii. A change in Arm settings.
- ix. When QC is out of range
- x. When the analyser prompts you to run a calibrator
- xi. Prepare and use AUTOCAL calibrators as per manufacturer's instructions

#### **Loading calibration data**

- i. Calibration: Go to Blank (BLK) screen
- ii. Select Position 1 for Blank and select tests
- iii. Calibration: Go to Calibration screen
- iv. Select Position 2 for Autocal and select tests

**Note: Both blank and Autocal for each test, has to be selected together to perform calibration**

- v. Calibrations are performed automatically and manually if needed.
- vi. Only accept successful calibration, conduct trouble shooting for a failed calibration.
- vii. Calibration reports are reviewed on the screen.

#### **5.14.11 Quality Control**

Conduct Internal Quality Control daily before testing patient samples. Two levels of QC (Humatrol N and Humatrol P) for each test should be run as per the manufacturer's instructions. Run control after cuvette clean

#### **Loading Controls**

- i. Load in sector 5 - and position from the Status/Samples tab (each QC position is predefined)
- ii. Remove the sector from the equipment
- iii. Place 500ul of controls (Humatrol N and Humatrol P) into Human star Cups in appropriate positions using the Eppendorf 1 ml Adjustable pipette.
- iv. Put the sector into tray .
- v. Requesting controls manually Click QC screen > Control tab>New>Select profile> Profiles group , click test for which you want to request a Control.
- vi. Click OK.
- vii. Review and accept successful Quality controls,
- viii. Trouble shooting
- ix. Conduct trouble shooting for a failed quality control.

- x. If the controls are outside limits follow Review of QC Results Procedure to resolve the problem
- xi. Document out of range results for Quality Controls runs on Quality Control Log.
- xii. Westergard charts will be printed for quality review every month
- xiii. If the QC results are inside the expected limits, proceed to run patient samples.
- xiv. If the IQC results are outside the expected limit raise a non conformance take and corrective action.

#### **5.14.12 Procedural Steps**

- a. Click Sample tray Icon>
- b. Place sample >Controls>Sample position>Exit>
- c. Load sample >Go to main Icon
- d. Main> Click>then go to start
- e. Start operation

#### **5.14.13 Biological Reference Intervals**

See annex 4.

#### **5.14.14 Interpretation And Reporting Of Results**

##### **Interpretate results**

This is based on the Biological reference interval. Normal results are patient results which fall within the reference range for the particular test. Abnormal results are those that fall below or above the reference range.

##### **Result reporting**

Report the obtained results from the machine into register book or request form

##### **Critical values**

Refer to clinical chemistry critical value chart (Annex 5). Immediate communication to the clinicians requesting the examination should be done and records are kept in the communication file.

#### **5.14.15 Limitation of the Procedure and Sources of Errors**

Haemolyzed and samples tested after 24 hours may give unreliable result

#### **5.14.16 Performance Characteristics**

Refer the method verification report

#### **5.14.17 Supporting Documents**

Sample collection manual

#### **5.14.18 References**

User manual for Operating Humastar 600.

## **5.15 PROCEDURE FOR BASIC BIOCHEMISTRY TESTS BY USING XL-180 ANALYSER.**

### **5.15.1 Purpose**

This Standard Operating Procedure (SOP) is aimed to describe step by step on how to operate the Erba XL-180 automated chemistry analyser using recommended sample at the health facilities in Tanzania.

### **5.15.2 Scope**

This procedure for Erba XL-180 will be used for Clinical chemistry testing in health facility in Tanzania

### **5.15.3 Responsibility**

A trained, qualified, competent and registered health laboratory practitioners are responsible for performing this procedure.

The head of section for chemistry is responsible for ensuring the effective implementation and competency assessment for this procedure.

### **5.15.4 Principle**

The analyzer is an automated clinical biochemistry analyzer based on the principle of photometry, it measures light transmittance at various wavelengths. White light as we see it is actually composed of several colors. This becomes evident, when we pass a beam of white light through a prism. If the light emerging from the prism on the opposite side were allowed to fall on a screen, we would see a wide spectrum of colors, beginning with red on the top and ending with violet at the bottom. The colors visible in between are in the order of indigo, blue, green, yellow, and orange

### **5.15.5 Sample Requirements**

Serum / heparanized plasma free from haemolysis should be used. Centrifuge at 3000 rpm for 5 min.

### **5.15.6 Equipment**

Perform the procedure for start-up, maintenance, troubleshooting and shut down the Era XL 200/600/640 analyser as per manufacturer's instrument instructions.

### **5.15.7 Materials**

Reagents kit, Calibrators, Controls, Printing papers, Disposable gloves, Laboratory coat, Micropipettes 100-1000 $\mu$ l, Sample rack, Refrigerator 2-8 $^{\circ}$ c, 0.15% Erba wash, Waste container, Distilled water, Wash containers, Blue and yellow tips Reaction rotor, Micropipettes 10-100ul, Micropipettes 5-50ul

### **5.15.8 Storage and Stability**

- Reagents are stored at 2-8  $^{\circ}$ c and contamination must be avoided, reagents are stable until the expiry date indicated on the label.
- Sample should be centrifuged and analyzed soon after receipt.

- Samples (serum/plasma) should be stored in the refrigerator 2-8 °c if there is delay in analysis.
- Refer to package inserts for sample stability.

#### **5.15.9 Safety**

- Front cover of the machine should be closed during operation to avoid contact with moving transfer arm and to reduce reagent and sample contamination.
- To assure operator safety and prolong the life of the Erba XL-180 clinical chemistry instrument, carefully follow all instructions outlined in the user manual
- Install the analyzer on flat working surface capable of supporting the equipment weight safely for safety and ventilation purposes.
- Use only power cord specified for Erba XL-180 clinical chemistry analyzer.
- Always wear protective gear and eye protection while using the instrument.
- Avoid excessive dust, wet/damp conditions and provide proper ventilation.
- Refer to user manual for further safety precautions.

#### **5.15.10 Calibration**

Perform calibration as per **Erba XL-180 operator user manual**.

Run the internal quality control samples to verify the performance of the machine

#### **5.15.11 Quality Control**

Quality control should be performed on a daily basis to verify the system calibration.

Other conditions that drive controls include:

- ✓ After a reagent lot number change
- ✓ After maintenance, component replacement, or a field service action
- ✓ After a software change
- ✓ Following calibration.
- ✓ According to regulatory requirements

#### **5.15.12 Procedural Steps**

- i. Before creating new orders, completed orders from the previous day should be purged if the machine has not already done so.
- ii. An order is created in as follows:
- iii. Click Orders > Sample Tab
- iv. Add patient ID # in the patient ID space
- v. Add laboratory number in the order ID space
- vi. Enter patient name, Age and sex
- vii. Select tests and click save
- viii. Click STAT on the status monitoring for a high Urgent(emergence) order (only for Urgent tests)
- ix. Click save
- x. Confirm sample positions, as follows:

- xi. Check the automatically assigned rack number and position for each sample. Modify the position as needed.
- **Loading samples on board**
- Once orders are entered into the system, print the sample position list by clicking on Place item> Choose sample position> print
- Set appropriate samples in Cryovial (need at least 300-500 ul sample vol) according to the loadlist.
- If using Erba Cups – must aliquot 300-500 ul using transfer pipette - Tap cups lightly on surface of hood to make sure no air bubbles on bottom of cup.

**NOTE: Position Number 1 is at the end farthest from the rotor handle. The position number is indicated on the right side of the rack.**

- Once all samples loaded, load the sample rack into one of the slots in the sample area.
- Make sure correct controls and calibrators are loaded on board in their pre-defined slots
- **Start Analyzing**
  - i. If the system is in standby, press start.
  - ii. If the system is sleeping, press start. Once the system is in standby, press start to begin the processing.
  - iii. Check the work list as the processing begins, as follows:
  - iv. Click Orders on the navigation bar and click the work list tab.
  - v. Check the work list for orders that are blocked or have no samples on board. Double click blocked order to see the reason for the blockage.
  - vi. Take the appropriate actions to resolve the problem.
  - vii. Results validation
  - viii. Software has been configured to automatically flag any Critical results, These tests are automatically repeated by the machine. Critical results must report as stated in SP-05\_Management of results procedure using FM-005\_Communication of critical results.
  - ix. These test results must be individually reviewed and accepted by the second personnel.
  - x. Click on the Validate tab of the Results work area. check all results located in the to validate folder
  - xi. To rerun or repeat a test
  - xii. Click on the validate tab in the results work area
  - xiii. Select a sample, calibration, or control order
  - xiv. Select the results in question
  - xv. Select rerun
  - xvi. Decide the dilution factor and then press Ok.
  - xvii. Accept a result
  - xviii. Click on the results in the result window

xix. Click accept

### **5.15.13 Biological Reference intervals**

See annex 4.

### **5.15.14 Results interpretation and reporting**

- Interpret results based on the Biological reference interval.
- Normal results are patient results which fall within the reference range for the particular test.
- Abnormal results are those that fall below or above the reference range. The test report is labeled H: High and L: Low to show the abnormality obtained.
- Once all of the results are accepted or validated, final report automatically be printed out.

### **5.15.15 Limitation of the Procedure and Sources of Error**

- Avoid using lipemic samples
- Avoid using haemolyzed samples as they can provide falsely results.
- Samples tested after 24 hours may give unreliable result
- avoid shaking violently; fibrin, bubbles might affect the results.
- Avoid repeated freezing and thawing
- Refer to package insert for interfering substances for specific analytes

### **5.15.16 Performance characteristics**

- Refer the method verification reports of this procedure and equipment manufacturer user manual.

### **5.15.17 Supporting document**

- Sample Collection Manual
- Safety Manual
- Quality Manual

### **5.15.18 References**

1. User manual for Erba XL 200/600/640.
2. Manufacturers package insert

## **5.16 PROCEDURE FOR OPERATING ERBA XL200/600/640 CHEMISTRY ANALYZER**

### **5.16.1 Purpose**

This Standard Operating Procedure (SOP) is aimed to describe step by step on how to operate the Erba XL200/600/640 automated chemistry analyser using recommended sample at the health facilities in Tanzania.

### **5.16.2 Scope**

This Erba XL200/600/640 Chemistry analyzer will be used for chemistry and electrolyte testing in health facility in Tanzania

### **5.16.3 Responsibility**

A trained, qualified and competent laboratory registered practitioners are responsible for performing this procedure. The head of section for chemistry is responsible for ensuring the effective implementation and competency assessment for this procedure.

### **5.16.4 Principle**

The ErbaXL200/600/640 chemistry analyser is used for diagnostic clinical chemistry testing. Classic chemistry, electrolytes, specific proteins, therapeutic drug monitoring, drugs of abuse, are consolidated into one system with one reagent cassette design. The instrument carries out all test orders automatically and is equipped with measuring modules:

FP photometer----- Fluorescence polarimetry

Absorbance photometer----- Absorbance photometry

ISE (Ion-Selective Electrode)-----Module Ion selective potentiometry

Samples are automatically transferred from a sample tube or cup to the module where the measurements are made. All optical measurements use the same transparent plastic containers, called cuvettes. The graphical user interface - running under Windows NT - provides quick and easy access to sample, control, and calibration data, while continuously monitoring all system functions. Colour-coded icons alert you to changes in the system status.

### **5.16.5 Sample Requirements**

Serum, plasma, CSF, Urine, Whole blood and other body fluids as per manufacturer package insert.

### **5.16.6 Equipments**

Erba XL 200/600/640.

### **5.16.7 Materials**

Controls, Printing papers, PPE, Micropipettes, Sample cups, Refrigerator 2-8°C, 0.15% Erba wash, Waste container, Distilled water

### **5.16.8 Storage and Stability**

- Store reagents, calibrators, and controls as per manufacture instructions.
- All reagents should be protected from direct sunlight, extreme heat, and freezing during shipment and storage.
  - Sample stability after collection of venous whole blood:
    - ✓ Samples run within eight hours of collection should be stored at Room Temperature.
    - ✓ Samples run more than eight hours after collection should be refrigerated (2°–8°C).

### **5.16.9 Safety**

Follow the following precaution requirements to ensure safety, system performance and accurate assay results.

- i. Decontaminate working surfaces twice daily, in the morning and afternoon
- ii. Temperatures for the room and refrigerator are recorded twice daily, in the morning and afternoon.
- iii. Adhere to safety precautions as stated in the Safety manual
- iv. All personal protective equipment (PPE) must be worn when performing this procedure.
- v. All samples must be regarded as potentially infectious.
- vi. Refer to National infection prevention and control Guidelines for health waste management and safety practice.
- vii. Avoid any contact between hands and eyes and nose during sample collection and testing.
- viii. Do not use reagent beyond its expiration date
- ix. The test device should be stored at 2 -30.0 C. And the test should be performed at room temperature..
- x. All spills should be wiped thoroughly using 1% sodium hypochlorite solution.

### **5.16.10 Calibration**

Perform calibration as **per Erba XL 200/600/640 operator user manual.**

### **5.16.11 Quality Control**

Quality control should be performed on a daily basis to verify the system calibration. Other conditions that drive controls include:

- ✓ After a reagent lot number change
- ✓ After maintenance, component replacement, or a field service action
- ✓ After a software change
- ✓ Following calibration.
- ✓ According to regulatory requirements

### **5.16.12 Procedural Steps**

#### **Creating Orders**



- i. Before creating new orders, completed orders from the previous day should be purged if the machine has not already done so.
- ii. An order is created in as follows:
- iii. Click Orders > Sample Tab
- iv. Add patient ID # in the patient ID space
- v. Add laboratory number in the order ID space
- vi. Enter patient name, Age and sex
- vii. Select tests and click save
- viii. Click STAT on the status monitoring for a high Urgent(emergence) order (only for Urgent tests). Click save.
- ix. Confirm sample positions by checking the automatically assigned rack number and position for each sample. Modify the position as needed.

### **Loading samples on board**

Once orders are entered into the system, print the sample position list by clicking on Place item> Choose sample position> print

Set appropriate samples in Cryovial (need at least 300-500 ul sample vol) according to the loadlist. If using Erba Cups – must aliquot 300-500 ul using transfer pipette - Tap cups lightly on surface of hood to make sure no air bubbles on bottom of cup.

***NOTE: Position Number 1 is at the end farthest from the rotor handle. The position number is indicated on the right side of the rack.***

Once all samples loaded, load the sample rack into one of the slots in the sample area. Make sure correct controls and calibrators are loaded on board in their pre-defined slots

### **Start Analyzing**

- i. If the system is in standby, press start.
- ii. If the system is sleeping, press start. Once the system is in standby, press start to begin the processing.
- iii. Check the work list as the processing begins, as follows:
- iv. Click Orders on the navigation bar and click the work list tab.
- v. Check the work list for orders that are blocked or have no samples on board. Double click blocked order to see the reason for the blockage.
- vi. Take the appropriate actions to resolve the problem.

### **Results validation**

- i. Software has been configured to automatically flag any Critical results, These tests are automatically repeated by the machine.
- ii. These test results must be individually reviewed and accepted by the second personnel.
- iii. Click on the Validate tab of the Results work area. Check all results located in the validation folder

### **To rerun or repeat a test,**

- i. Click on the validate tab in the results work area
- ii. Select a sample, calibration, or control order
- iii. Select the results in question. Select rerun
- iv. Decide the dilution factor and then press Ok.
- v. Accept a result
- vi. Click on the results in the result window
- vii. Click accept

#### **5.16.13 Biological Reference intervals**

See annex 4.

#### **5.16.14 Results interpretation and reporting**

- i. Interpretate results based on the Biological reference interval.
- ii. Normal results are patient results which fall within the reference range for the particular test.
- iii. Abnormal results are those that fall below or above the reference range. The test report is labeled H: High and L: Low to show the abnormality obtained.
- iv. Once all of the results are accepted or validated, final report automatically be printed out.

#### **5.16.15 Limitation of the Procedure and Sources of Error**

- i. Avoid using lipemic samples
- ii. Avoid using haemolyzed samples as they can provide falsely results.
- iii. Samples tested after 24 hours may give unreliable result
- iv. avoid shaking violently; fibrin, bubbles might affect the results.
- v. Avoid repeated freezing and thawing
- vi. Refer to package insert for interfering substances for specific analytes

#### **5.16.16 Performance characteristics**

Refer to the method verification reports of this procedure.

#### **5.16.17 Supporting document**

Sample Collection Manual, Safety Manual, Quality Manual

#### **5.16.18 References**

User manual for Erba XL 200/600/640.

Manufacturers package insert

## 5.17 PROCEDURE FOR CHEMISTRY TEST USING COBAS INTEGRA 400 PLUS CHEMISTRY ANALYSER

### 5.17.1 Purpose

The purpose of this procedure is to provide a detailed instruction on how to perform basic chemistry and Therapeutic Drug Monitoring test In human samples by using Cobas Integra 400 plus Analyzer for the provision of the clinical chemistry results.

### 5.17.2 Scope

This procedure is used in Clinical chemistry section for processing Chemistry samples using Cobas Integra 400 Plus Analyzers..

### 5.17.3 Responsibility

Trained, qualified and competent laboratory registered practitioners are responsible for performing this procedure. The head of section for chemistry is responsible for ensuring the effective implementation and competency assessment for this procedure

### 5.17.4 Principle

The Cobas Integra 400 Plus uses photometric and Ion-Selective Electrode potentiometric technology to measure analytes concentrations in samples. There are two fundamental types of photometric assays on this instrument:

**End Point Measurement:** Measurements are taken by the photometer at specific measure point. Beers law establishes the mathematical relationship between the absorbance of the solution and the concentration of the analytes. The absorbance of the solution changes as the reaction progresses. If the measurements are taken after the reactions completion, the intensity of colored or turbidity product is an indicator of sample component's concentration. These are called **End-point assay**.

**Rate Assays;** Measurements are taken as reactions proceed; the rate of the reaction is proportional to the sample component's concentration or Activity being analyzed. These are called **Rate reaction Ion Selective Electrode (ISE)**

**Potentiometric** as a detection technology used by the machine to measure electrical potential in a sample. The analyzer uses a unique property of selective membrane-electrode in contact with both the test solution and an internal filling solution to develop an electrical Potential/Electromotive force (EMF). The internal filling solution contains the test-ion at a fixed concentration. The test ions will closely associate with the membrane of each side. The membrane EMF is determined by the difference in concentration of the test ions in the test solution and internal filling solution. The EMF develop according to the Nernst equation for a specific ion in solution. (see reagent package inserts for detail)

### 5.17.5 Sample requirements

2-5mls of venipuncture blood collected in either plain vacutainer (red top) or vacutainer with lithium-heparin (green top).

Do not use blood sample collected in red top tubes to test for blood glucose.

EDTA for glycated Haemoglobin. Centrifuged serum/plasma

### **5.17.6 Equipment**

Cobas Integra plus 400. Maintenances and other troubleshooting's should be performed as per manufacture instructions.

### **5.17.7 Materials**

<b>Reagents</b>	<b>Consumables</b>
Reagents kit Calibrators Controls	White sample cups Sample rack with/without adaptors Reagent rack Distilled water Laboratory coat Disposable gloves Micropipette 100-1000µl

### **5.17.8 Storage and stability**

- **Sample stability after collection of venous whole blood:**
  - ✓ Samples run within eight hours of collection should be stored at Room Temperature.
  - ✓ Samples run more than eight hours after collection should be refrigerated (2°–8) °C.
- Any refrigerator-stored samples should be brought to room temperature before mixing and processing.
- Retain the processed sample at 2 – 8°C for minimum of 3days
- Reagents and consumables are stored as per manufacturer instructions

### **5.17.9 Safety**

- Adhere to safety precautions as stated in the Safety manual/IPC guideline
- All personal protective equipment (PPE) must be worn when performing this procedure.
- All samples must be regarded as potentially infections.

### **5.17.10 Calibration**

Perform calibration as per Cobas Intergra Plus 400 user manual.

Run the internal quality control samples to verify the performance of the machine

### **5.17.11 Quality Control**

Use commercial or in-house made Quality control materials to perform on daily basis before testing patient samples or:

- i. After a reagent lot number change
- ii. After maintenance, component replacement, or a field service action
- iii. After a software change
- iv. Following calibration.

### **5.17.12 Procedural Steps**

- i. When there are multiple requests from one sample start by running General Chemistry and then Immunoassays.
- ii. If the sample is not sufficient to do all requested tests, consult with the Head of section or any senior staff to determine which tests to prioritize.
- iii. Centrifuge all the samples for 10 minutes at 3000 rpm.
- iv. Arrange the samples on the Racks and note the positions.
- v. Log on to the system by typing your user ID And Password
- vi. Go to the Cobas Monitor Screen to order patient samples for processing.
- vii. Click <Order> followed by <sample> Order ID
- viii. Enter the barcode number, Sample Type, followed by both Rack number and the position of the sample
- ix. Click STAT for a high priority order
- x. Select The requested test then save
- xi. The system starts processing automatically as soon as you insert rack

### 5.17.13 **Biological reference interval**

See annex 4.

### 5.17.14 **Interpretation and reporting of results**

#### **Interpretation of results**

- is based on the Biological reference range;
- Normal results are patient results which fall within the reference range for the particular test.
- Abnormal results are results which falls above or below the reference ranges

#### **Reporting of results**

- Review and report the displayed patient results on either reister/request forms or LIS

#### **Critical results**

<b>Analyte</b>	<b>Less Than</b>	<b>Greater Than</b>
Amylase	25U/L	150U/L
Chloride	85 mmol/L	115mmol/L
CK	30U/L	200U/L
Creatinine	26umol/L	120umol/L
Glucose(fasting)	2.5mmol/L	20.0mmol/L
Potassium	2.5mmol/L	6.0mmol/L
Sodium	120mmol/L	160mmol/L
Bilirubin Total	3.4umol/L	20.5umol/L
Bilirubin Total for new Born	<b>Newborn</b> 24hours ≥ 1374umol/L 48hours ≥ 2224umol/L 84hours ≥ 2904umol/L	

	One week to one month $\geq 3424 \mu\text{mol/L}$	
Urea (BUN)	1.0mmol/L	54mmol/L

#### **5.17.15 Limitation of the Procedure and Sources of Error**

- Icteric samples that appears with yellow colour of the serum or plasma due to bilirubin accumulation.
- Samples for glucose should be tested within 2 hours from the time of receipt as delay causes falsely low results.
- Samples tested after 24 hours may give unreliable results
- Avoid using lipemic samples

#### **5.17.16 Performance characteristics**

Refer the method verification reports

#### **5.17.17 Supporting documents**

- Sample Collection Manual
- Safety Manual
- Quality Manual

#### **5.17.18 References**

- Cobas integral plus 400 user manual
- Manufacturer package insert

## **5.18 PROCEDURE FOR PERFORMING CHEMISTRY TEST USING COBAS 6000**

### **5.18.1 Purpose**

The purpose of this procedure is to provide a detailed instruction on how to perform basic chemistry and Therapeutic Drug Monitoring test In human samples by using Cobas Integra 6000 plus Analyzer for the provision of the clinical chemistry results.

### **5.18.2 Scope**

This procedure is used in Clinical chemistry section for processing Chemistry samples using Cobas Integra 6000Plus Analyzers

### **5.18.3 Responsible personnel**

Trained, qualified and competent laboratory registered practitioners are responsible for performing this procedure. The head of section for chemistry is responsible for ensuring the effective implementation and competency assessment for this procedure

### **5.18.4 Principle**

The Cobas 6000 analyzer is a powerful tool for complete diagnostic laboratory automation. It is optimized for high throughput workloads using a combination of an ion selective electrode (ISE) and photometric analysis (c 501 module), and an immunoassay analysis module (e 601 module), used for diagnostic clinical chemistry testing. Classic chemistry, electrolytes, specific proteins, therapeutic drug monitoring, drugs of abuse, are consolidated into one system with one reagent cassette design. The instrument carries out all test orders automatically and is equipped with measuring modules:

- Ion selective electrode modul
- Photometric analysis ( c 501 module)
- Immunoassay analysis module (e 601 module).

#### ***ION SELECTIVE ELECTRODE Principle( ISE unit)***

The ISE unit performs indirect measurement of electromotive force (EMF) in millivolts between ion selective electrodes and the reference electrode. Indirect measurement means that all samples are diluted at 1:13 ratio. The EMF values of each sample are converted to mmol/L values by a calculation algorithm that uses the 4EMF data together with data from a two-point calibration with two primary standards. For this one-point calibration the internal standard (IS) is used.

#### ***PHOTOMETRIC PrincipleS (c 501)***

There are two fundamental types of photometric assays on this instrument: **Endpoint** and **Rate assays**.

Measurements are taken by the photometer at specific measuring point. If measurements are taken after the reactions completed, the intensity of the colored (or turbidity) product is an indicator of the sample components concentration. These are called end point assays.

If measurements are taken as the reaction proceeds, the rate of the reaction is proportional to the sample components concentration or activity being analyzed. These are called rate reactions.

### ***IMMUNOLOGY PrincipleS (e601)***

Three test principles are available on the e 601: **Competitive principle** for extremely small analytes, **Sandwich principle** for larger analytes and **Bridging principle** to detect antibodies in the sample.

#### ***Sandwich principle***

It is applied to higher molecular weight analytes, such as thyroid-stimulating hormone (TSH). In first step, patient sample is combined with reagents containing biotinylated TSH antibody (R1) and a ruthenium-labeled TSH-specific antibody (R2) in assay cup. During the incubation step, antibodies capture the TSH present in the sample. Second step, streptavidin-coated paramagnetic microbeads are added, biotinylated antibody attaches to the streptavidin-coated surface of the microbeads. And mixture transported to the measuring cells. The immune complexes are magnetically entrapped on the working electrode. But unbound reagent and sample are washed away by **Procell M**.

In Electrochemiluminescence (ECL) reaction, the conjugate is a ruthenium based derivatives and the chemiluminescent reaction is electrically stimulated to produce light. The amount produce is directly proportional to the amount of TSH in the sample.

**COMPETITIVE Principle** which is applied for for analytes with extremely low molecular weight. In first step, sample and a specific anti-T3 antibody (R1) with a ruthenium complex are combined in an assay cup. This is incubated for the appropriate time for the assay. Second step, biotinylated T3 antigen (R2) and streptavidin-coated paramagnetic microbeads are added. During the second incubation the still free binding sites of the labeled antibody become occupied, with formation of an antibody-hapten complex. The entire complex is bound to the microbead via interaction of biotin and streptavidin. And reaction mixture transported into the measuring cell. The immune complexes are magnetically entrapped on the working electrode. But unbound reagent and sample are washed away by **Procell M**. In ECL reaction, the conjugate is a ruthenium based derivatives and the chemiluminescent reaction is electrically stimulated to produce light. The amount produce is directly proportional to the amount of TSH in the sample.

#### ***RIDGING TEST Principle***

The Bridging principle is applied to high molecular weight antigens, such as Anti-HAVIgM and Anti-HBcIgM. Whereby the measurement is directly proportional to the sample concentration. i.e **Low** signal=**low** concentration and **High** signal=**high** concentration

#### ***5.18.5 Sample requirements***

- Refer to the laboratory sample collection manual. 2-5mls of venipuncture blood collected in either plain vacutainer (red top) or vacutainer with lithium-heparin (green top).



- Do not use blood sample collected in red top tubes to test for blood glucose.
- EDTA for glycated Haemoglobin
- Volume of 2-5ml of blood will be centrifuged
- Sample should be at the laboratory within two hours after collection of whole blood.
- Haemolysed samples may cause unreliable results

### 5.18.6 Equipment

Cobas Integra plus 6000

Maintenances and other troubleshooting's should be performed as per manufacture instructions.

### 5.18.7 Materials

Reagent	Consumables
Reagent kits Calibrators. Controls	Sample cups Hitach cups Storage box Gloves 70% alcoholsolution in alcohol bottle Magazine Pipette tips 100 -200ul Pipette tips 100 – 1000ul Sample container rack Discard bin Micropipette holder

### 5.18.8 Storage and stability

- **Sample stability after collection of venous whole blood:**
  - ✓ Samples run within eight hours of collection should be stored at Room Temperature.
  - ✓ Samples run more than eight hours after collection should be refrigerated (2°–8) °C.
- Any refrigerator-stored samples should be brought to room temperature before mixing and processing.
- Retain the processed sample at 2 – 8°C for minimum of 3days
- Reagents and consumables are stored as per manufacturer instructions

### 5.18.9 Safety

- i. Adhere to safety precautions as stated in the Safety manual/IPC guideline
- ii. All personal protective equipment (PPE) must be worn when performing this procedure.
- iii. All samples must be regarded as potentially infections.

### 5.18.10 Calibration

Perform calibration as per Cobas Intergra Plus 400 operator user manual.

Run the internal quality control samples to verify the performance of the machine

#### **5.18.11 Quality Control**

Use commercial or in-house made Quality control materials to perform on daily basis before testing patient samples or:

- i. After a reagent lot number change
- ii. After maintenance, component replacement, or a field service action
- iii. After a software change
- iv. Following calibration.

#### **5.18.12 Procedural steps**

- i. Adhere to the following steps to process routine samples .
- ii. Prepare sample racks with the correct color and rack numbers according to sample types (such as Ser/PI,Urine,CSF..)
- iii. For all routine sample use gray racks.
- iv. To verify the correct rack numbers for each type refer to the **Rack Assignment** area on the **Utility>System** screen.
- v. Place the sample in the prepared sample racks. Ensure the sample barcode are facing the open slot in the rack so the barcode reader can scan them.
- vi. Place the routine sample racks onto a rack tray in the correct orientation. The barcode labels of the sample racks have to be on the right side when placing the tray into the rack loader. The loader is on the left side.
- vii. To start: Choose Start (global button). Verify the setting on the Start Condition screen. Choose Start (on the Start Conditions screen) the analyzer performs preparation routine and then begins to process the sample.

#### **5.18.13 Biological Refences**

See annex 4.

#### **5.18.14 Interpretation and Reporting of Results**

- **Interpretation of results**
  - is based on the Biological reference range;
  - Normal results are patient results which fall within the reference range for the particular test.
  - Abormal results are results which falls above or below the reference ranges
- **Reporting of results**
  - Review and report the displayed patient results on either reister/request forms or LIS
- **Critical results:** See annex 4.

#### **5.18.15 Limitation of the Procedure and Sources of Error**

- Icteric samples that appears with yellow colour of the serum or plasma due to bilirubin accumulation.

- Samples for glucose should be tested within 2 hours from the time of receipt as delay causes falsely low results.
- Samples tested after 24 hours may give unreliable results. Avoid using lipemic samples

#### **5.18.16      *Performance Characteristics***

Refer the method verification reports.

#### **5.18.17      *Supporting Document***

- Sample Collection Manual
- Safety Manual
- Quality Manual

#### **5.18.18      *References***

- i. Cobas integral plus 6000 user manual
- ii. Manufacturer package insert

## **5.19 PROCEDURE FOR DETERMINATION OF BASIC BIOCHEMISTRY TEST USING ARCHITECTPLUS C4000**

### **5.19.1 Purpose**

This procedure provides detailed instructions on how to perform basic chemistry tests using Architect plusc4000 for the provision of chemistry results.

### **5.19.2 Scope**

This procedure is used in Clinical chemistry section for processing Chemistry samples using Architect C4000 Analyzers

### **5.19.3 Responsible personnel**

Trained, qualified and competent laboratory registered practitioners are responsible for performing this procedure. The head of section for chemistry is responsible for ensuring the effective implementation and competency assessment for this procedure

### **5.19.4 Principle**

The Architect system uses photometric and potentiometric technology to measure analytic concentrations in samples.

#### **Photometric technology**

It is the measurement of the amount of light a sample absorbs and involves passing a beam of light through a sample and measuring the intensity of the light that reaches a detector. Beer's law establishes the mathematical relationship between the absorbance of the solution and the concentration of the analyte. The absorbance of the solution changes as the reaction progresses and measurements are taken when either all reactants are depleted and the reaction is stable (end-point assays) or when the reactant reaches a stable rate (rate assays).

#### **Potentiometry**

It is a detection technology used by the machine to measure electrical potential in a sample. The machine uses an ICT (Integrated Chip Technology) module to measure potentiometric assays (electrolytes  $K^+$ ,  $Na^+$ ,  $Cl^-$ ,  $CO_3^-$ ,  $CO_2$ ). ICT methodology obtains milli volt readings and convert to assay specific conversion units. The measurements of ICT reference solution and ICT samples are used to calculate the assay results.

### **5.19.5 Sample Requirements**

Volume of 2- 4 ml of Human whole blood collected in plain (red top) or Lithium –heparin (green top) vacutainers. For serum, leave blood for 30 minutes to ensure blood clot formation and centrifuge at 3000 rpm for 5 minutes to obtain serum. EDTA tube for HbA1C, BNP, Tarcolimus, and Cycrosporine; light blue (sodium citrate) for D- dimer test.

### **5.19.6 Equipment**

Architect C4000 analyser

Maintenances and other trouble shooting should be performed as per manufacturer's instructions.

### 5.19.7 Materials

Reagent	Consumables
Reagents kit Controls Calibrators	ICT reference solution, Alkaline wash, Acid wash, Detergent A, 10% detergent B solution, 0.5% acid wash solution, Water bath additive, ICT sample diluent, ICT cleaning fluid, 0.5% sodium hypochlorite solution, 70% alcohol, Normal Saline, Sample cups, Carousel, Examination Gloves, Gauze, cotton

### 5.19.8 Storage and Stability

- **Sample stability after collection of venous whole blood:**
  - ✓ Samples run within eight hours of collection should be stored at Room Temperature.
  - ✓ Samples run more than eight hours after collection should be refrigerated (2°–8) °C.
- Any refrigerator-stored samples should be brought to room temperature before mixing and processing.
- Retain the processed sample at 2 – 8°C for minimum of 3days
- Reagents and consumables are stored as per manufacturer instructions

### 5.19.9 Safety

- i. Adhere to safety precautions as stated in the Safety manual/IPC guideline
- ii. All personal protective equipment (PPE) must be worn when performing this procedure.
- iii. All samples must be regarded as potentially infections.
- iv. Avoid any contact between hands and eyes and nose during sample collection and testing.

### 5.19.10 Calibration

Perform calibration as per C4000 operator user manual.

### 5.19.11 Quality Control

Use commercial or in-house made Quality control materials to perform on daily basis before testing patient samples or:

- i. After a reagent lot number change
- ii. After maintenance, component replacement, or a field service action
- iii. After a software change
- iv. Following calibration.

### **5.19.12 Procedure Steps**

- i. Click on **<Order>** followed by **<patient order>**
- ii. Centrifuge all samples for 10 minutes at 3000 rpm
- iii. Arrange the samples on the carousel and note the positions.
- iv. Go to the Architect computer screen to order patient samples, select **<Order >** followed by **<patient order>**
- v. Enter the carousel ID number by bar code scanner or manually followed by the position.
- vi. Select the requested test(s) from the assay list as written on the sample request form
- vii. Click on F2 (sample details) to add patient details (Patient ID, patient name, age, sex, address/location, name of the requesting Doctor, etc.)
- viii. Click **<done>** to save your and return to the patient order screen.
- ix. Press F3 to add order.
- x. Repeat step 3 to 7 for the remaining samples in the same carrier.
- xi. Load the sample into the carrier in their proper position as indicated in the order status.
- xii. Load the carrier onto the RSH on the steady section. The machine automatically starts to process the sample.
- xiii. When sample processing is complete, select results from the menu bar, result review will display, click release for results to be printed.
- xiv. All the undone tests will be shown on the **<exception button>**, if any, click on the exception button and solve the error indicated by the machine, then select the test and click re-run.
- xv. Re-running patient sample, click on **<Result review>**, highlight the result to be re-run, click on Re-run. Reseat the C/P containing sample to be re-run.

### **5.19.13 Biological Reference Interval**

See annex 4.

### **5.19.14 Interpretation and Reporting of Results**

- **Interpretation of results**
  - Is based on the Biological reference range;
  - Normal results are patient results which fall within the reference range for the particular test.
  - Abnormal results are results which falls above or below the reference ranges
- **Reporting of results**
- Review and report the displayed patient results on either reister/request forms or LIS
- **Critical results**

Refer to the critical results chart for biochemistry tests (Annex 5)

### **5.19.15 Limitation of the Procedure and Sources of Error**

- i. Icteric samples that appears with yellow colour of the serum or plasma due to bilirubin accumulation.

- ii. Samples for glucose should be tested within 2 hours from the time of receipt as delay causes falsely low results.
- iii. Samples tested after 24 hours may give unreliable results Avoid using lipemic samples
- iv. Samples tested after 24 hours may give unreliable results

**5.19.16 Performance Characteristics**

Refer into method verification reports.

**5.19.17 Supporting document**

Sample Collection Manual, Safety Manual, Quality Manual

**5.19.18 References**

Architect C4000 user Manual

Manufacturers package insert

## **5.20 PROCEDURE FOR OPERATING MAGLUMI 2000 ANALYZER**

### **5.20.1 Purpose**

This Standard Operating Procedure (SOP) is aimed to describe step by step on how to perform immunological tests using Maglumi 2000 samples in the Laboratory

### **5.20.2 Scope**

This procedure is used in Clinical chemistry section/unit for processing Chemistry samples for immune assay test using Maglumi 2000 Analyzer in the Laboratory

### **5.20.3 Responsibility**

Trained, qualified and competent laboratory registered practitioners are responsible for performing this procedure. The head of section for chemistry is responsible for ensuring the effective implementation and competency assessment for this procedure

### **5.20.4 Principle**

The analyzer's photomultiplier is used to detect light produced in chemiluminescence reaction, within the wavelengths ranging between 300nm to 650nm. The light peak of the chemiluminescence is emitted at a wavelength of 420nm. The light produced in chemiluminescence reaction is emitted to the photomultiplier and reaches the photocathode plane through the incidence window triggering photons on the photocathode plane emitting photo electrons into a vacuum. Photo electrons accumulate at the first dynode through the focusing electrode, pass subsequent dynode for secondary electron multiplication, and then secondary electrons emitted from the last dynode are output through the anode. The photomultiplier anode collects secondary electrons after multiplication by dynodes and outputs current signals through an external circuit.

To eliminate differences between photomultipliers and ensure test result consistency between different analyzer, relative light unit (RLU) is used as the unit of measurement for original data.

After being pipetted to the cuvette, samples and reagents are blended washed and separated before the cuvette is sent to the chamber. Starter 1 is injected into the first hole in the cuvette bar and then Starter 2 is injected into the same hole after 2.5 seconds triggering chemiluminescence reaction. Detection of optical signals starts 0.1 second after the chemiluminescence reaction and obtains optical signals of 3.0 seconds. Repeat this step to detect the other five holes in the cuvette bar.

### **5.20.5 Sample Requirement**

2-5mls of venipuncture blood collected in either plain vacutainer (red top) or vacutainer with lithium-heparin (green top). EDTA for glycated Haemoglobin, BNP, Tarcolimus and Cyclosporine. Vacutainer with Sodium citrate (Light Blue) for D- DIMER test. Centrifuged serum/plasma

### **5.20.6 Equipment**

Maglumi 2000



## **Maintenance**

Perform maintenance as per manufacturer's instrument instructions.

### **5.20.7 Materials**

Reagents kit, Maglumi system tubing cleaning solution, Wash concentrate, Reaction module, Maglumi light check liquid, Maglumi starter1&2, hydrogenperoxide solution, Examination gloves, Micropipette 100-1000µl

### **5.20.8 Storage And Stability**

- **Sample stability after collection of venous whole blood:**
  - ✓ Samples run within eight hours of collection should be stored at Room Temperature.
  - ✓ Samples run more than eight hours after collection should be refrigerated (2°–8) °C.
- Any refrigerator-stored samples should be brought to room temperature before mixing and processing.
- Retain the processed sample at 2 – 8°C for minimum of 3days
- Reagents and consumables are stored as per manufacturer instructions

### **5.20.9 Safety**

- Adhere to safety precautions as stated in the Safety manual/IPC guideline
- All personal protective equipment (PPE) must be worn when performing this procedure.
- All samples must be regarded as potentially infections.

### **5.20.10 Calibration**

Perform calibration as per Maglumi **2000** operator user manual.

Run the internal quality control samples to verify the performance of the machine

### **5.20.11 Quality Control**

Use commercial or in-house made Quality control materials to perform on daily basis before testing patient samples or:

- i. After a reagent lot number change
- ii. After maintenance, component replacement, or a field service action
- iii. After a software change
- iv. Following calibration.

### **5.20.12 Procedural Steps**

- i. Edit sample and test
- ii. Load sample rack
- iii. Place the sample tube into rack and make sure the barcode faces the barcode reader (if available), then insert the sample rack to the end of any free track of sample of sample area.
- iv. Avoid repeated freezing and thawing.

- v. For different parameters, sample volume is different. Refer to " Test procedure" in the reagent kit specification where sample volume and calibrator volume are specified. For example, sample volume for TSH is 100ul. Along with dead volume 100ul, at least 200ul of sample (serum, plasma etc.) is required. Therefore, in the case of TSH, 250ul of control of each test is suggested.
- vi. Centrifuge the samples for 15 minutes over 400rpm.
- vii. Edit the sample ID and assay.
- viii. The system will recognise and download the sample and assay information from the LIS/HIS host with barcode automatically; or twice input sample ID and assign the assay/ profile to respective sample manually.
- ix. Click <Worklist> button to check the sample list.
- x. Then click <Edit> button to modify or click <Save> to save it.

### **5.20.13 Biological Reference Interval**

See annex 4.

### **5.20.14 Interpretation and reporting of results**

#### **Interpretation of results**

- Is based on the Biological reference range;
- Normal results are patient results which fall within the reference range for the particular test.
- Abnormal results are results which falls above or below the reference ranges

#### **Reporting of results**

Review and report the displayed patient results on either reister/request forms or LIS

#### **Critical results**

Refer to the critical results chart for biochemistry tests (Annex 5)

### **5.20.15 Limitation of the Procedure and Sources of Error**

Samples for glucose should be tested within 2 hours from the time of receipt as delay causes falsely low results.

Samples tested after 24 hours may give unreliable results

Avoid using lipemic samples .

### **5.20.16 Performance characteristics**

Refer the method verification reports

### **5.20.17 Supportive Documents**

Sample Collection Manual, Safety Manual, Quality Manual

### **5.20.18 References**

- i. Maglumi 2000 Operating Instructions Manual
- ii. Manufacturer inserts

## **5.21 PROCEDURE FOR PERFORMING BASIC CHEMISTRY AND IMMUNOASSAY TESTS USING ARCHITECT Ci4100 PLUS ANALYSER.**

### **5.21.1 Purpose**

This procedure provides instructions on how to operate an Architect ci4100 analyzer to perform both basic chemistry and immune assay tests.

### **5.21.2 Scope**

This procedure is used with the chemistry section at Hospital Laboratory aimed at processing clinical chemistry and immune assay tests by using architect ci4100 analyzer.

### **5.21.3 Responsibility**

The section head is responsible for effective implementation of this procedure and ensure that only competent laboratory staff can operate the Architect ci4100 analyzer to process clinical chemistry and immune assay tests.

### **5.21.4 Principle**

The Architect system uses photometric, potentiometric and/or Chemiluminescent Microparticle Immunoassay (CMIA) technology to measure analytic concentrations in samples.

Photometric method is the process used by the c System to measure sample absorbance for the quantification of analyte concentration.

**Photometric technology** is the measurement of the amount of light a sample absorbs and involves passing a beam of light through a sample and measuring the intensity of the light that reaches a detector. Beer's law establishes the mathematical relationship between the absorbance of the solution and the concentration of the analyte. The absorbance of the solution changes as the reaction progresses and measurements are taken when either all reactants are depleted and the reaction is stable (end-point assays) or when the reactant reaches a stable rate (rate assays).

**Chemiluminescence is the emission of light due to chemical reaction.** Is the technology used by the machine to determine the presence of antigens, antibodies and analyte in sample.

### **5.21.5 Sample Requirements**

- i. Volume of 2- 4 ml of Human whole blood collected in plain (red top) or Lithium – heparin (green top) vacutainers.
- ii. Serum/plasma from centrifuged blood at 3000 rpm for 5 minutes.
- iii. EDTA tube for HbA1C, BNP, Tarcolimus, and Cyclosporine; light blue (sodium citrate) for D- dimer test.

### **5.21.6 Equipment**

Architect ci4100 analyzer

Maintenance and other troubleshooting should be performed as per manufacturer instructions.

### 5.21.7 Materials

Reagent	Consumables
Assay specific reagents kit Controls ( level 1 – 3) Calibrators (Low – High) as per the assay specific reagent	ICT reference solution, Alkaline wash Acid wash, Detergent A, 10% detergent B solution, 0.5% acid wash solution, Water bath additive, ICT sample diluent, ICT cleaning fluid, 0.5% sodium hypochlorite solution, 70% alcohol, Normal Saline, Sample cups, Carousel, Examination Gloves, Gauze, Cotton, Pre trigger, Trigger solution, Concentrated wash buferr solution,

### 5.21.8 Storage and Stability

- Reagents and other consumables must be stored as per manufacture instructions in their original containers, but reagents are normally stored at 2-8°C when in use. On board stability of reagent and solution is attained by the in built refrigerator on the reagent supply center. For any delay in sample processing, serum/plasma should be separated from whole blood and stored at 2-8°C or frozen.
- Frozen samples should be centrifuged prior testing to remove red blood cells, fibrin and particulate matter.
- Control samples are frozen and are stable until their expiration dates.

### 5.21.9 Safety

- i. Adhere to safety precautions as stated in the Safety manual/IPC guideline
- ii. All personal protective equipment (PPE) must be worn when performing this procedure.
- iii. All samples must be regarded as potentially infections.

### 5.21.10 Calibration

Perform calibration as per C4000 operator user manual.

### 5.21.11 Quality Control

Use commercial or in-house made Quality control materials to perform on daily basis before testing patient samples or:

- i. After a reagent lot number change
- ii. After maintenance, component replacement, or a field service action
- iii. After a software change
- iv. Following calibration.

### 5.21.12 Procedural Steps

- i. Click on <Order> followed by <patient order>
- ii. Centrifuge all samples for 10 minutes at 3000 rpm
- iii. Arrange the samples on the carousel and note the positions.

- iv. Go to the Architect computer screen to order patient samples, select **<Order >** followed by **<patient order>**
- v. Enter the carousel ID number by bar code scanner or manually followed by the position.
- vi. Select the requested test(s) from the assay list as written on the sample request form
- vii. Click on F2 (sample details) to add patient details (Patient ID, patient name, age, sex, address/location, name of the requesting Doctor, etc.)
- viii. Click **<done>** to save your and return to the patient order screen.
- ix. Press F3 to add order.
- x. Repeat step 3 to 7 for the remaining samples in the same carrier.
- xi. Load the sample into the carrier in their proper position as indicated in the order status.
- xii. Load the carrier onto the RSH on the steady section. The machine automatically starts to process the sample.
- xiii. When sample processing is complete, select results from the menu bar, result review will display, click release for results to be printed.
- xiv. All the undone tests will be shown on the **<exception button>**, if any, click on the exception button and solve the error indicated by the machine, then select the test and click re-run.
- xv. Re-running patient sample, click on **<Result review>**, highlight the result to be re-run, click on Re-run. Reseat the C/P containing sample to be re-run.

### **5.21.13 Biological Reference Intervals**

See annex 4.

### **5.21.14 Interpretation and Reporting of Results**

#### **Interpretation of results**

- is based on the Biological reference range;
- Normal results are patient results which fall within the reference range for the particular test.
- Abnormal results are results which falls above or below the reference ranges

#### **Reporting of results**

- Review and report the displayed patient results on either reister/request forms or LIS

#### **Critical results**

Refer to the critical results chart for biochemistry tests and immunoassays.

### **5.21.15 Limitation of the Procedure and Sources of Errors**

- i. Hemolysed samples provide falsely high results of potassium and low results for glucose.
- ii. Avoid highly lipaemic samples

- iii. Samples for glucose should be processed within 2 hours of collection, any delay would cause falsely low results.
- iv. Potential operator errors and ARCHITECT system technology limitations.
- v. See package inserts as per each specific assay reagent instruction for more details on limitation and source of errors.

#### **5.21.16 Performance Characteristics**

Refer to the method verification report.

#### **5.21.17 Supporting Documents**

- i. Sample collection manual GM-1-03.3
- ii. Safety manual
- iii. Procedure for review, reporting and release of patient results.
- iv. Sample collection manual

#### **5.21.18 References**

- i. Architect Package inserts for Reagent, Control and Calibration materials.
- ii. Architect C4100 Operational user manual.

## **5.22 PROCEDURE FOR PERFORMING IMMUNOASSAY TESTS BY USING MAGLUMI 800 IMMUNO - ANALYSER**

### **5.22.1 Purpose**

The purpose of this procedure is to provide detailed instructions on how to perform immunoassay test using maglumi 800.

### **5.22.2 Scope**

This procedure is used in clinical chemistry section for processing immunoassay samples by using Maglumi 800

### **5.22.3 Responsibility**

Qualified and competent registered Health laboratory practitioners and health care providers respectively are responsible for doing this test procedure.

The head of clinical chemistry section is responsible for ensuring the effective implementation of this procedure

### **5.22.4 Principle**

The analyzer's photomultiplier is used to detect light produced in chemiluminescence reaction, within the wavelengths range between 300nm to 650nm. The light peak of the chemiluminescence is emitted at a wavelength of 420nm. The light produced in chemiluminescence reaction is emitted to the photomultiplier and reaches the photocathode plane through the incidence window, triggering photons on the photocathode plane emitting photoelectrons into a vacuum. Photoelectrons accumulate at the first dynode through the focusing electrode, pass subsequent dynode for secondary electron multiplication, and then secondary electrons emitted from the last dynode are output through the anode. The photomultiplier anode collects secondary electrons after multiplication by dynodes and outputs current signals through an external circuit.

After being pipetted to the cuvette, samples and reagents are blended, washed and separated before the cuvette is sent to the chamber. Starter 1 is injected into the first hole in the cuvette bar, and then Starter 2 is injected into the same hole after 2.5 seconds, triggering chemiluminescence reaction. Detection of optical signals starts 0.1 second after the chemiluminescence reaction and obtains optical signals of 3.0 seconds. Repeat this step to detect the other five holes in the cuvette bar

### **5.22.5 Sample Requirements**

Centrifuged whole blood sample (serum/plasma)

### **5.22.6 Equipment**

Maglumi 800 analyzer

#### **Maintenance**

Conduct daily, weekly, monthly, quarterly and as needed equipment maintenance as required by the equipment maintenance schedule. Conduct equipment maintenance by Clicking <System> then select the type of maintenance required which is either <Daily>, <Weekly>

### 5.22.7 Materials

Reagents	Consumables
Reagent kits	Maglumi system tubing cleaning solution, Wash concentrate. Reaction module, Maglumi light check liquid, Maglumi starter 1: catalyst in 1.5% NaOH, Maglumi starter 2: 0.21 hydrogen peroxide solution, Examination Glove.

### 5.22.8 Storage and Stability

Processed samples are stored at 2-8°C for minimum of 3 days

### 5.22.9 Safety

- Adhere to safety precautions as stated in the facility laboratory Safety manual
- All personal protective equipment (PPE) must be worn when performing this procedure.
- All samples must be regarded as potentially infectious.

### 5.22.10 Calibration

Follow the Calibration steps as per manufacturer instruction

### 5.22.11 Quality Control

Quality controls are conducted under the following conditions:

- i. Run Quality controls daily specifically at the beginning of each day
- ii. Divide internal QC into quarters (500ul); keep them in -20 degree centigrade for longer use.
- iii. Interpret the Levy-Jennings chart using the Westgard rules.
- iv. Analyse the quality control material only when an analyser is to be used for processing patient samples and not otherwise.

### Quality Control Procedure Steps

- i. Select the position of control in <Patients > menu, click <Control > button.
- ii. Avoid bubbles in the sample tube when conducting quality control.
- iii. Click the assay button to choose it. After choosing it will run to green. Press <SAVE> button to save it, then click **Start** button to run the control.

### Quality control results

Check Levy Jennings chart to find out if validated QC results obey westgard rule

If the system test, QC be out of range, please at first, **re-run again**.

If this keeps happening, please refer to *trouble shooting menu*.

### 5.22.12 Procedure Steps

- i. Load the serum/plasma sample rack
- ii. Place the sample tube into rack and make sure the barcode faces the barcode reader (if available), then insert the sample rack to the end of any free track of sample of sample area.
- iii. Suggestive centrifugation time and speed: **15 minutes over 400rpm.**
- iv. Edit the sample ID and assay.



- v. The system will recognise and download the sample and assay information from the LIS/HIS host with barcode automatically; or twice input sample ID and assign the assay/profile to respective sample manually.
- vi. After sample edited, click <**Work list**> button to check the sample list. Then click <**Edit**> button to modify or click <**Save**> to save it. For emergency sample, after sample ID and assay edition, choose the sample position and click the <**START**> button to set the STAT mode for emergent Samples.
- vii. After confirm the sample ID and assay, click <**Start**> button to start the test.

#### **5.22.13 Biological Reference Interval**

See annex 4.

#### **5.22.14 Interpretation and Reporting of Results**

##### **Results interpretation**

Results should be interpreted based on biological reference intervals and patient clinical history.

##### **Reporting of results**

Report the obtained results from the machine into register/request form

##### **Critical results**

See annex 4.

#### **5.22.15 Limitation of the Procedure and Sources of Error**

- Avoid using haemolyzed samples as they will provide falsely results.
- Samples tested after 24 hours may give unreliable result
- Avoid shaking violently; fibrin, hemolysis, bubbles might affect the results.

#### **5.22.16 Performance Characteristics**

Refer the method verification report

#### **5.22.17 Supporting Documents**

Maglumi 800 user manual

#### **5.22.18 References**

Maglumi 800; Operating Instructions. Fully-auto chemiluminescence immunoassay analyzer

## 5.23 PROCEDURE FOR IMMUNOASSAYS BY USING ARCHITECT i1000SR

### 5.23.1 Purpose

This Standard Operating Procedure (SOP) is aimed to describe step by step on how to perform immunological tests using Architect i1000SR samples at Laboratory.

### 5.23.2 Scope

This procedure for Architect i1000SR Chemistry analyzer will be used for immunochemistry testing in health facility in Tanzania

### 5.23.3 Responsibility

Trained, qualified and competent laboratory registered practitioners are responsible for performing this procedure. The head of section for chemistry is responsible for ensuring the effective implementation and competency assessment for this procedure

### 5.23.4 Principle

The Architect i1000SR uses Chemiluminescent Microparticle Immunoassay(CMIA) technology to measure and quantify analyte concentration in samples. CMIA is a detection technology used by the machine to determine the presence of antigens , antibodies, and analytes in samples. The reactants necessary for CMIA technology are paramagnetic micro particle coated with capture molecule (antigens, antibodies or viral particles) specific for the analyte being measured pink reagents vials Acridinium-labelled conjugate- yellow reagent vials. Pre trigger solution (Hydrogen peroxide) and Trigger solution(sodium hydroxide)

### 5.23.5 Sample Requirements

2-5mls of venipuncture blood collected in either plain vacutainer (red top) or vacutainer with lithium-heparin (green top). EDTA for glycated Haemoglobin ,BNP, Tarcolimus and Cyclosporine. Vacutainer with Sodium citrate (Light Blue) for D- DIMER test. Haemolyzed sample may cause un reliable results to patient

### 5.23.6 Equipment

Architect i1000SR

#### Equipment maintenance

Perform the procedure for start-up, maintenance, troubleshooting and shut down the analyser as per manufacturer's instructions.

### 5.23.7 Materials

Reagent	Consumables
Reagents kit Calibrator Controls	Trigger solution, Pre-trigger solution, Concentrated wash buffer, Sample cups, Reaction vessels, Carousel, Examination gloves, Printing paper, Micropipette 100-1000µl Refrigerator 2-8°C

### 5.23.8 Storage and Stability

Sample stability after collection of venous whole blood:

- ✓ Samples run within eight hours of collection should be stored at Room Temperature.
- ✓ Samples run more than eight hours after collection should be refrigerated (2°–8) °C.
- Any refrigerator-stored samples should be brought to room temperature before mixing and processing.
- Retain the processed sample at 2 – 8°C for minimum of 3days
- Reagents and consumables are stored as per manufacturer instructions

### 5.23.9 Safety

- Adhere to safety precautions as stated in the Safety manual/IPC guideline
- All personal protective equipment (PPE) must be worn when performing this procedure.
- All samples must be regarded as potentially infectious.

### 5.23.10 Calibration

- Perform calibration as per **Architect i1000SR** operator user manual.
- Run the internal quality control samples to verify the performance of the machine.

### 5.23.11 Quality Control

Use commercial or in-house made Quality control materials to perform on daily basis before testing patient samples or:

- i. After a reagent lot number change
- ii. After maintenance, component replacement, or a field service action
- iii. After a software change
- iv. Following calibration.

### 5.23.12 Procedural Steps

- i. Centrifuge all samples for 10 minutes at 3000 rpm
- ii. Arrange the samples on the carousel and note the positions.
- iii. Go to the Architect computer screen to order patient samples, select **<Order >** followed by **<patient order>**
- iv. Enter the carousel ID number by bar code scanner or manually followed by the position.
- v. Select the requested test(s) from the assay list as written on the sample request form
- vi. Click on F2 (sample details) to add patient details (Patient ID, patient name, age, sex, address/location, name of the requesting Doctor, etc.)
- vii. Click **<done>** to save your and return to the patient order screen.
- viii. Press F3 to add order.
- ix. Repeat step 3 to 7 for the remaining samples in the same carrier.

- x. Load the sample into the carrier in their proper position as indicated in the order status.
- xi. Load the carrier onto the RSH on the steady section. The machine automatically starts to process the sample.
- xii. When sample processing is complete, select results from the menu bar, result review will display, click release for results to be printed.
- xiii. All the undone tests will be shown on the <exception button>, if any, click on the exception button and solve the error indicated by the machine, then select the test and click re-run.

Re-running patient sample, click on <**Result review**>, highlight the result to be re-run, click on Re-run. Reseat the C/P containing sample to be re-run.

### **5.23.13 Biological Reference Interval**

See annex 4.

### **5.23.14 Interpretation and Reporting of Results**

- **Interpretation of results**
  - Is based on the Biological reference range;
- **Reporting of results**
  - Review and report the displayed patient results on either reister/request forms or LIS
- **Critical results**

Refer to the critical results chart for immunoassay tests (Annex 4)

### **5.23.15 Limitation of the Procedure and Sources of Error**

- Samples for glucose should be tested within 2 hours from the time of receipt as delay causes falsely low results.
- Samples tested after 24 hours may give unreliable results
- Avoid using lipemic samples .

### **5.23.16 Perfomance characteristics**

Refer the method verification reports

### **5.23.17 Supporting document**

- Sample Collection Manual, Safety Manual, Quality Manual

### **5.23.18 References**

- Architect i1000SR support Technical Training (operational manual)
- Manufacturers package insert

## **CHAPTER 6: SEROLOGY**

---

### **6.1 PROCEDURE FOR SYPHILIS ANTIBODIES RAPID TEST**

#### **6.1.1 Purpose**

This procedure provides instructions for Qualitative detection of antibodies of all isotopes against *Treponema pallidum*

### **6.1.2 Scope**

The procedure is used in all Laboratory areas for screening syphilis infection

### **6.1.3 Responsibility**

Qualified and trained Medical Laboratory Technicians, Technologists and Scientist are responsible for implementing this test procedure.

The Head serology is responsible for ensuring the effective implementation and maintenance of this procedure.

### **6.1.4 Principle**

The syphilis Ab Rapid test strip (Serum/plasma) is a lateral flow chromatographic immunoassay based on the Principle of the double antigens–sandwich technique, In this test syphilis recombinant antigen is immobilized in the test line region of the strip test device, After sample is added to the sample well of the device it react with syphilis recombinant antigen coated particles in the test. This mixture migrates chromatographically along the length of the test strip and interacts with immobilized syphilis antigens.

If the sample contains syphilis antibodies a coloured line will appear in the test line region indicating positive results. If the sample does not contain syphilis antibodies a coloured line will not appear in the region, indicating a negative result

### **6.1.5 Sample Requirements**

Whole blood/plasma sample in purple tube (EDTA)

Serum from clotted blood sample in plain tube.

### **6.1.6 Equipment**

Centrifuge, Timer, Micropipette

#### **Maintenance**

Maintenance of the equipment should be performed as per schedule

### **6.1.7 Materials**

<b>Reagents</b>	<b>Consumables</b>
Syphilis Ab Rapid Test Strips kit Known Positive control, Known Negative control	Marker pen Examination Gloves

### **6.1.8 Storage and Stability**

- The kit should be stored at 2-30 °C until the expiry date printed on the sealed pouch or as instructed by the manufacturer.
- Do not freeze the kit or exposing it over 30°C.
- Store Serum and plasma sample at 2-8°C for up to 3 days.
- For long term storage, serum/plasma should be kept below -20°C

### **6.1.9 Safety**

- i. Adhere to safety precautions as stated in the Safety manual/IPC guideline
- ii. All personnel protective equipment (PPE) must be worn when performing this procedure.
- iii. All samples must be regarded as potentially infectious.

### **6.1.10 Calibration**

Perform calibration of equipment as per calibration schedule

### **6.1.11 Quality Control**

A known Negative and Positive in-house controls once every week and whenever a new kit is opened.

### **6.1.12 Procedural Steps**

- i. Bring the test kit and sample to room temperature before use.
- ii. Remove the test from its sealed pouch, and use it as soon as possible.
- iii. Place the test strip on a clean, dry flat surface
- iv. Label the test strip with the Patient ID
- v. For serum or plasma sample;
- vi. Hold the dropper vertically and transfer 2 drops of serum or plasma (approximately 60µl) onto the sample pad of the test strip.
- vii. Read test results in 15 minutes. Do not interpret results after 15 minutes.
- viii. For whole blood sample;
- ix. Hold the dropper vertically and transfer 2 drops of whole blood (approximately 50ul) onto the sample pad of the test strip.
- x. Then add 1 drop of buffer (approximately 30ul) and start the timer.
- xi. Read test results in 15 minutes.
- xii. Do not interpret test results after 15 minutes

### **6.1.13 Biological Reference Interval**

Not applicable

### **6.1.14 Interpretation and Reporting of Results**

- Interpretation of results

**Negative** - Only one coloured band appears on the control(C) region. No apparent band on the test (T) region

**Positive** - In addition to a pink coloured control (C) band, a distinct pink coloured band will also appear in the tests (T) region

**Invalid** – a total absence of colour in both regions or no coloured line appears on the control (C) region is an indication of procedure error or the tests deterioration. Repeat the test with a new kit.

- **Reporting of results**

Report results as: Syphilis - Negative or syphilis – Positive

- **Critical value**

Not applicable

#### **6.1.15 Limitation of the Procedure and Sources of Error**

- i. The syphilis Ab rapid test strip should be stored at room temperature (15-30°C)
- ii. Humidity and temperature can adversely affect results.
- iii. Do not use test if pouch is damaged or broken
- iv. Do not use it beyond expiration date.
- v. Do not perform the test in a room with strong air flow. i.e. an electric fan strong air-condition
- vi. Test is for single use only. Do not re use test.

#### **6.1.16 Performance Characteristics**

Refer manufacture kit insert for specificity and sensitivity.

#### **6.1.17 Supporting Document**

Sample collection manual, Safety manual

#### **6.1.18 References**

Manufacturer Kit insert for syphilis

## **6.2 PROCEDURE FOR (HIV) TESTING BY USING BIOLINETM HIV 1/2 3.0 TEST**

### **6.2.1 Purpose**

The purpose of this procedure is to describe the method of performing Bio line HIV-1/HIV-2 rapid test assay.

### **6.2.2 Scope**

This procedure is applicable to all HIV-1/HIV-2 rapid test using Bio line HIV-1/HIV-2

### **6.2.3 Responsibility**

Qualified, registered, licenced and trained Medical personnel are responsible for implementing this test procedure.

The Head of Serology is responsible for ensuring the effective implementation and maintenance of this procedure.

### **6.2.4 Principle**

SD Bioline HIV-1/HIV-2 is a rapid HIV qualitative immune-chromatographic assay used to detect antibodies to HIV in human blood, serum or plasma as the sample had been added to sample pad. As the sample migrates through the conjugate pad, it reconstitutes and mixes with the selenium colloid-antigen conjugate. This mixture continues to migrate through the solid phase to the immobilized recombinant antigens and synthetic peptides at the sample window site. If antibodies to HIV-1 and/or HIV-2 are present in the sample, the antibodies bind to the antigen-selenium colloid and to the antigen at the client window, forming a red line at the client window site. If antibodies to HIV-1 and/or HIV-2 are absent, the antigen selenium colloid flow past the client window and no red line is formed at the client window site.

### **6.2.5 Sample Requirements**

2-3mls Whole blood/plasma/ serum

### **6.2.6 Equipment**

Timer, Centrifuge, Micropipette, Refrigerator.

#### **Maintenance**

Maintenance of equipment should be performed as per schedule

### **6.2.7 Materials**

Abbott Bioline TM HIV 1/2 3.0 Test/kit, Assay diluent, Disposable gloves, Laboratory coat

### **6.2.8 Storage and Stability**

The test kit should be stored at a temperature between 1°C and 30°C or as per manufacturer claims

**Whole blood;** If the blood sample is not immediately tested, it should be refrigerated at 2-8°C for 3days

**Plasma or serum;** If plasma or serum sample is not tested immediately, it should be refrigerated at 2-8°C for 7 days



For storage period longer than 2week, freezing below -20°C is required. They should be brought to room temperature 15-30°C prior to use.

### **6.2.9 Safety**

Adhere to safety precautions as stated in the facility Safety manual /IPC guideline  
All personal protective equipment (PPE) must be worn when performing this procedure.

All samples must be regarded as potentially infectious.

### **6.2.10 Calibration**

Perform calibration of equipment as per calibration schedule

### **6.2.11 Quality Control**

Run known Negative and Positive in-house controls daily before performing patient samples or when new test kit is opened.

### **6.2.12 Procedure Steps**

- i. Bring reagents and samples to room temperature before use.
- ii. Tear off the desired number of test strips from the 10-test card by bending and tearing off along the perforated line.
- iii. Label the strips with sample identification number or patient/client identification number.
- iv. Peel the foil cover from the reagent area of the test strips.

#### **For serum or plasma samples;**

- v. Apply 10 µl of sample using a precision pipette to the sample pad (marked by the arrow symbol).
- vi. In the absence of precision pipette apply 1 drop of sample using plastic Pasteur pipette provided by manufacture in the kit.
- vii. Then apply 4 drop of buffer to the sample pad.
- viii. Wait for a 10 to 20 minutes and read results.

#### **For whole blood collected by finger prick method;**

- ix. Apply 20 µl of sample (collected by EDTA capillary tube) to the sample pad (marked by the arrow symbol).
- x. In the absence of precision pipette or EDTA capillary tube, apply 1 drop of sample using plastic Pasteur pipette provided by manufacture in the kit.
- xi. then apply 4 drops of buffer to the sample pad. Wait for 10 to 20 minutes and read results.

#### **For whole blood collected by venepuncture method;**

- xii. Apply 20 µl of sample using a precision pipette to the sample pad (marked by the arrow symbol).
- xiii. Then apply four (4) drops of buffer to the sample pad.
- xiv. Wait for 10 minutes (up to 20 minutes) and read results.

### **6.2.13 Biological Reference Interval**

Not applicable

#### **6.2.14 Interpretation and Reporting of Results**

##### **Result interpretation**

##### **Negative Result**

The presence of only control line(C) within the result window indicate a negative result

##### **Positive Result**

The presence of two lines as C and T -1(1) within the window indicates positive results for HIV-1

The presence of two lines as C and T -2 (2) within the window indicates positive results for HIV-2

The presence of three lines as C, T-1(1) and T-2(2) within the result window indicates a positive result for HIV-1 and/or HIV -2

##### **Invalid results**

No presence of control line (C) or/and pink/purple band observed in the result window Indicate an invalid result. The direction may not have been followed correctly or the test

may have deteriorated. It is recommended that the sample be retested.

##### **Reporting of results**

- i. Reactive test Results will be reported as POSITIVE
- ii. Non-reactive test results will be reported as NEGATIVE

##### **Critical value**

- Not applicable

#### **6.2.15 Limitation of the Procedure and Sources of Error**

- Avoid haemolysed sample and beware of lipemic samples
- Samples other than blood have not been validated to give accurate results.
- Intensity of the patient bar does not necessarily correlate to the titre of antibody
- A negative result with BIOLINE HIV-1/2 does not exclude the possibility of an infection with HIV.

#### **6.2.16 Performance Characteristics**

Refer to the method verification report of this procedure.

#### **6.2.17 Supporting Documents**

Sample collection Manual, HIV rapid testing algorithm

#### **6.2.18 References**

Package insert Abbott Bioline <sup>TM</sup> HIV-1/2 3.0

## **6.3 PROCEDURE FOR PERFORMING (HIV) BY USING UNIGOLD TEST**

### **6.3.1 Purpose**

The purpose of this procedure is to describe the method of testing HIV-1 and HIV-2 using Trinity Biotech Uni-Gold test assay.

### **6.3.2 Scope**

This procedure is applicable in all sites that perform Trinity Biotech Uni-Gold HIV test

### **6.3.3 Responsibility**

- Qualified, registered, licenced and trained Medical personnel are responsible for implementing this test procedure.

The Head serology is responsible for ensuring the effective implementation and maintenance of this procedure.

### **6.3.4 Principle**

Recombinant proteins representing the immune-dominant regions of the envelope proteins of HIV-1 and HIV-2, glycoprotein gp-41, gp120 (HIV-1) and glycoprotein gp36 (HIV-2) respectively are immobilized at the test region of the nitrocellulose strip. These proteins are also linked to colloidal gold and impregnated below the test region of the device. A narrow band of the nitrocellulose membrane is also sensitized as a control region. Antibodies to HIV-1 and HIV-2 react with the colloidal gold linked antigens. The antibody protein-colloidal gold complex moves chromatographically along the membrane to the test and control regions of the test device.

### **6.3.5 Sample Requirements**

Whole blood/plasma sample collected in purple tube (EDTA)

Serum from clotted blood sample in plain tube

Centrifuge sample at 3000rpm for 5 minutes to obtain serum of plasma.

### **6.3.6 Equipment**

Stop watch, Micropipette, Centrifuge, refrigerator

### **6.3.7 Materials**

Uni-Gold™ HIV test-kit, Disposable gloves, Laboratory coat, 70% alcohol

### **6.3.8 Storage and stability**

Uni-Gold™ HIV test device and wash solution should be stored between 2-27°C or as per manufacturer instructions

Whole blood sample should be stored at 2-8°C for up to 3 days at -20°C or below

### **6.3.9 Safety**

- Adhere to safety precautions as stated in the Facility Safety manual/ IPC guideline
- All personal protective equipment (PPE) must be worn when performing this procedure.

- All samples must be regarded as potentially infections.

### **6.3.10 Calibration**

Perform equipment calibration as per Schedule

### **6.3.11 Quality Control**

Run known Negative and Positive in-house controls once a week.

The test strips contain a control line, which turns colored if the run is valid.

### **6.3.12 Procedure Steps**

- i. Bring reagents and samples to room temperature at least 20 minutes before use.
- ii. Remove the test device from its protective wrapper.
- iii. Label the device with sample identification number or patient/client identification number.
- iv. Peel the foil cover from the reagent area of the test strips.
- v. For serum or plasma or whole blood collected by finger prick or venipuncture samples;
- vi. Using one of the disposable pipettes supplied with the kit, fill it with the sample.
- vii. Holding the pipette over the sample port, add two drops of sample (approximately 60 µl) carefully to the sample port of the test device.
- viii. Add two drops (approximately 60 µl) of wash reagent to sample port and start the timer.
- ix. Wait for a minimum of 10 minutes (up to 12 minutes) and read results

### **6.3.13 Biological Reference Intervals**

Not Applicable

### **6.3.14 Interpretation and Reporting of Results**

#### **Results interpretation**

- **Reactive test results**

Two pink/red lines of the intensity in the device window, the first adjacent to letter 'T' (test) and the second adjacent to 'C' (control).

- **Non – reactive test results**

A pink/red line of the intensity adjacent to the letter 'C' (control). But no pink/red line adjacent to 'T' (test) this indicates a Non-Reactive result.

- **Invalid results**

No pink/red line appears in the device window adjacent to the letter "C" (control) irrespective of whether or not a pink /red line appears in the device window adjacent to "T" (test). This is an **INVALID** result that cannot be interpreted. An invalid result must be repeated

#### **Results reporting**

- **Reactive test results: Report as HIV TEST POSITIVE**

- **Non-reactive test results**-repeat 1<sup>st</sup> and 2<sup>nd</sup> tests following the national HIV testing algorithm
- If the test results are still discordant report - **INCONCLUSIVE** then inform the patient for retesting after 14 days
- If after 14 days, the test is still discordant report - **INCONCLUSIVE**

Collect fresh venous blood sample, refer the sample for ELISA testing

#### **Critical Values**

- Not Applicable

#### **6.3.15 Limitation of the Procedure and Sources of Error**

- Avoid hemolyzed sample and beware of lipemic samples when interpreting results.
- The BIOLINE HIV-1/2 test is designed to detect antibodies to HIV-1 and HIV-2 in human serum, plasma and whole blood. Other body fluids or pooled samples may not give accurate results.
- Intensity of the patient bar does not necessarily correlate to the titer of antibody in the sample.
- A negative result with BIOLINE HIV-1/2 does not exclude the possibility of an infection with HIV.

#### **6.3.16 Performance Characteristics**

Refer to the method verification report

#### **6.3.17 Supporting Documents**

Sample collection manual

HIV rapid testing algorithm

#### **6.3.18 References**

Manufacture package insert (Trinity Biotech Uni-Gold HIV)

## 6.4 PROCEDURE FOR URINE PREGNANCY TEST

### 6.4.1 Purpose

This procedure provides instructions for Qualitative detection of HCG in urine

### 6.4.2 Scope

The procedure is used in the serology section in detection of pregNot applicablency

### 6.4.3 Responsibility

Qualified,trained and competent Medical Laboratory Technicians, Technologists and scientist are responsible for implementing this test procedure.

The Head Microbiology is responsible for ensuring the effective implementation and maintenance of this procedure.

### 6.4.4 Principle

The Human Chorionic GoNot applicabledotropin One Step PregNot applicablency Test Strip (urine) is rapid chromatographic immunoassay for the qualitative detection of Human Chorionic GoNot applicabledotropin in urine to aid in early detection of pregNot applicablency. The test uses two lines to indicate results. The test line is pre coated with a monocloNot applicable Human Chorionic GoNot applicabledotropin antibody to selectively detect elevated level of Human Chorionic GoNot applicabledotropin. The control line is pre coated with goat anti-mouse IgG antibody. The test also includes a burgundy coloured conjugate paid containing another monocloNot applicable HCG antibody conjugated with colloidal gold. The assay is conducted by immersing the test strip in a urine sample and observing the formation of coloured lines .The sample migrate via capillary action along the membrane to reach with coloured conjugate. Positive sample reacts with the specific antibody HCG coloured conjugate to form a coloured line at the test line region of the membrane. Absence of this coloured line suggest a negative results

### 6.4.5 Sample requirements

Fresh Urine collected from either morning,evening or any other time

### 6.4.6 Equipment

Stop watch

Refrigerator

### 6.4.7 Materials

Reagents	Consumables
HCG test kit	Disposable gloves, Laboratory coat

### 6.4.8 Storage and stability

Test strips reagent are stable at 2 to 30° C up to expiration date or as per manufacturer instruction

If sample cannot be tested within 1 hour of collection, it should be stored at 2 - 8°C for 24hrs

#### **6.4.9 Safety**

- i. Adhere to safety precautions as stated in the Facility Safety manual/ IPC guideline.
- ii. All personal protective equipment (PPE) must be worn when performing this procedure.
- iii. All samples must be regarded as potentially infectious.

#### **6.4.10 Calibration**

Perform equipment calibration as per schedule

#### **6.4.11 Quality control**

Run known Negative and Positive in-house controls (known patient or EQA sample) once a week or when the new kit is opened

#### **6.4.12 Procedure Steps**

- i. Remove the test strip from the sealed pouch and use it as soon as possible.
- ii. With arrow pointing towards the urine sample immerse the test strip vertically in the urine sample for at least 10 to 15 seconds. Do not pass the maximum line (MAX) on the test strip when immersing the strip.
- iii. Place the test strip(s) on the non absorbent flat surface, start the timer and wait for the colored line(s) to appear. The results should be ready in 5 minutes.

#### **6.4.13 Biological reference intervals**

Not applicable

#### **6.4.14 Interpretation and reporting of results**

##### **Results interpretation**

**POSITIVE:** two distinct colored lines appear. One line should be the control line region (C) and another line should be on test line region (T).

**NEGATIVE:** one colored line appears in control line region (C) no apparent colored line appears in the first line (T).

**INVALID:** control line fails to appear in both the control region.

##### **Reporting of results**

Report results as PregNot applicability test Negative or PregNot applicability test Positive.

#### **6.4.15 Limitations of the Procedure and Sources of Error**

- i. The hCG one step pregnancy test strip (urine) is preliminary qualitative test therefore neither the quantitative nor the rate of increase of hCG can be determined by this test.

- ii. Very dilute urine sample as indicated by low specific gravity may not contain representative level of hCG. If pregnancy is still suspected the first morning urine sample should be collect 48 hours later and tested.
- iii. first trimester pregnancies terminate for natural reasons, a test result that is weakly positive should be confirmed by retesting with first morning urine sample collected 48 hours later.
- iv. This test may produce false positive results. A number of conditions other than pregnancy including trophoblastic disease and certain non trophoblastic neoplasms including testicular tumours, prostate cancer, breast cancer and lung cancer, causes elevated level of hCG. Therefore the presence of hCG in the urine should not be used for the diagnosis pregnancy unless this condition has been ruled out.
- v. This test may produce false negative results. False negative results may occur when the levels of hCG are below the levels of sensitivity level of the test. When pregnancy is still suspected a first morning urine sample should be collected 48 hours later and tested. In case pregnancy is suspected and the test continue to produce negative result see a physician for further diagnosis.

#### **6.4.16 Performance Characteristics**

Refer to the method verification report of this procedure

#### **6.4.17 Supporting documents**

Sample collection manual

#### **6.4.18 References**

HCG package insert



## **6.5 PROCEDURE FOR HEPATITIS C ANTIBODY RAPID TEST**

### **6.5.1 Purpose**

The purpose of this procedure is to give instructions on how to perform Hepatitis C Virus Antibody (HCV Ab) rapid test.

### **6.5.2 Scope**

This procedure is applicable to all site perform hepatitis C Virus Antibody rapid tests

### **6.5.3 Responsibility**

It is the responsibility of the Head of serology Section to ensure effectively implemented by all personnel working in the serology section.

### **6.5.4 Principle**

The HCV Ab Rapid test Strip is a lateral flow chromatographic immunoassay based on the Principle of the double antigen- sandwich technique. The test strip consists of 1) a burgundy colored conjugate pad containing HCV antigens conjugated with colloidal gold (HCV Ag conjugates) and rabbit IgG-gold conjugates, 2) a nitrocellulose membrane strip contain a test band (T band) and a control band (C band). The T band is pre-coated with non- conjugated HCV antigens, and the C band is pre-coated with goat anti-rabbit IgG. When an adequate of test sample is dispensed into the sample well of the strip, the sample migrates by capillary action across the strip. The antibodies: either the IgG, the IgM, or the IgA, to HCV if present in the sample will bind to the HCV Ag conjugates. The immunocomplex is then captured on the membrane by the pre coated HCV antigens, forming a burgundy colored T band, indicating a HCV Ab positive test result. Absence of the T band suggests a negative result. The test contains an internal control (C band) which should exhibit a burgundy colored band of the immunocomplex of goat anti rabbit IgG / rabbit IgG-gold conjugates regardless the presence of any antibodies to HCV. Otherwise, the test result is invalid and the sample must be retested with another device.

### **6.5.5 Sample requirement**

2-3mls whole blood/serum/plasma. To obtain serum, Centrifuge blood collected in plain red top tube at 3000rpm per 3 minutes. To obtain Plasma, Centrifuge blood collected in EDTA tube at 3000rpm per 3 minutes

### **6.5.6 Equipment**

Timer, Centrifuge and Refrigerator

### **6.5.7 Materials**

Reagents	Consumables
HCV Ab test kit (Test strips, disposable dropper and HCV Ab buffer)	Disposable gloves, Laboratory coat Micropipette

### **6.5.8 Storage and stability**

- a. The test device in the sealed pouch can be stored at 2-40<sup>0</sup>C or as instructed by manufacturer up to the expiration date. The test device must remain in the sealed pouch until use. **DO NOT FREEZE**
- b. Store whole blood at 2-8<sup>0</sup>c for up 3 days
- c. Serum and plasma maybe stored at 2-8<sup>0</sup>c for up 7 days, for long term storage, serum and plasma samples should be kept at-20<sup>0</sup>c or below.

#### **6.5.9 Safety**

- i. Adhere to safety precautions as stated in the Facility Safety manual/ IPC guideline
- ii. All personal protective equipment (PPE) must be worn when performing this procedure.
- iii. All samples must be regarded as potentially infections.

#### **6.5.10 Calibration**

Listed equipment will be calibrated as per calibration schedule.

#### **6.5.11 Quality control**

Run known Negative and Positive in-house controls once a week or when new test kit is opened

#### **6.5.12 Procedure Steps**

Allow test strip, sample, buffer and/or controls to equilibrate to room temperature prior to testing.

- i. Remove the test device from the foil pouch and use it as soon as possible. best results will be obtained if the assay is performed within one hour.
- ii. Place the test device on a clean and level surface.
- iii. Label the test device with sample ID
- iv. **For venepuncture** whole blood samples; Hold the dropper vertically and transfer 2 drops of venipuncture whole blood (approximately 50ul) to the sample pad of the strip, then add 1 drop of buffer (approximately30ul) and start the timer.

**For finger stick** whole blood sample; allow 2 hanging drops of fingerstick whole blood (approximately 50ul) to fall into the center of the sample pad on the test strip, then add 1 drop of buffer(approximately 30ul) and start the timer.

**For serum or plasma sample;** Hold the dropper vertically and transfer 1 drop of serum or plasma(approximately30ul) to the sample pad of the test strip, then add 1 drop of buffer (approximately 30ul) and start the timer.

- v. Wait for the red line(s)to appear. the result should be read in 15 minutes.do not interpret the result after 15 minutes

### **6.5.13 Biological Reference Intervals**

Not Applicable

### **6.5.14 Interpretation and Reporting of Results**

- **Interpretation of results**

**Positive;** two colored lines should be observed. The line in the test region (T) is the prone line; The line in the control region (C) is the control line, which is used to indicate proper performance of the device.

**Negative;** The control line appears in the test, but the test line is not visible.

**Invalid;** No line appears in the control region. Under no circumstances should a positive sample be identified until the control line forms in the viewing area if the control line does not form, the test result is inconclusive and the assay should be repeated

#### **Reporting of results**

**Reactive test result - HCV Ab rapid test positive**

**Non - reactive test results - HCV Ab rapid test Negative**

### **6.5.15 Limitations Of The Procedure And Source Of Error**

- i. The HCV Ab Rapid Test cassette (whole blood, serum, plasma) is for in vitro diagnostic use only. This test should be used for the detection of antibodies to HCV in whole blood, serum or plasma sample.
- ii. The HCV Ab Rapid Test cassette (whole blood, serum, plasma) will only indicate the presence of antibodies to HCV in the sample and should not be used as the sole criteria for the diagnosis of hepatitis C viral infection.
- iii. A negative result can occur if the quantity of the antibodies to HCV present in the sample is below the detection limits of the assay, or the antibodies that are detected are not present during the stage of disease in which a sample is collected.

### **6.5.16 Performance Characteristics**

Refer to method verification report of this procedure

### **6.5.17 Supporting Document**

Sample collection manual

### **6.5.18 References**

HCV Ab Package inserts

Kit manufacturer paper insert

## 6.6 PROCEDURE FOR CRYPTOCOCCAL ANTIGEN RAPID TEST PROCEDURE

### 6.6.1 Purpose

The purpose of this procedure is to give instructions on how to perform cryptococcal antigen rapid test.

### 6.6.2 Scope

This procedure will be used by all staff and students perform CrAg test

### 6.6.3 Responsibility

It is the responsibility of the Head of serology Section to ensure effectively implemented and maintained.

### 6.6.4 Principle

The CrAg Lateral Flow Assay is a dipstick sandwich immune-chromatographic assay. Samples and sample diluent are added into an appropriate reservoir, such as a test tube, and lateral flow device is placed into the reservoir. The test uses sample wicking to capture gold- conjugated, anti-Crag monoclonal antibodies and gold conjugated control antibodies deposited on the test membrane. If Crag is present in the sample, then it binds to the gold conjugated, anti-CrAg. The gold labelled antibody antigen complex continues to pick up the membrane where it will interact with the test line, which has immobilized anti-Crag monoclonal antibodies. The gold labelled antibody-antigen complex forms a sandwich at the test line causing a visible line to form. With proper flow and reagent reactivity, the wicking of any sample, positive or negative, will cause the gold- conjugated control antibody to move to the control line. Immobilized antibodies at the control line will bind to the gold conjugated control antibody and form a visible control line. Positive test results create two lines (test and control). Negative test results from only one line (control). If control line fails to develop then the test is invalid.

### 6.6.5 Sample Requirement

2-3mls serum, plasma, whole blood (venous and finger prick) and cerebral spinal fluid;  
**NOTE 1:** To obtain serum, Centrifuge blood collected in plain red top tube at 3000rpm per 3 minutes

**NOTE 2:** To obtain Plasma, Centrifuge blood collected in EDTA tube at 3000rpm per 3 minutes

### 6.6.6 Equipment

Timer, Centrifuge and Refrigerator

### 6.6.7 Materials

Reagents	Consumables
CrAg test kit (CrAg LF Test strip, LF Sample diluents, LF titration diluents, CrAg positive control)	Disposable gloves, Laboratory coat Micropipette

### 6.6.8 Storage And Stability

- i. If a delay is encountered in sample processing, store at 2-8°C for up to 72 hours is permissible.
- ii. CSF, plasma, serum may be stored for longer period at -20°C provided they are not repeatedly thawed and refrozen
- iii. Whole blood in transit should be maintained at 2-8°C not -20°C.

#### **6.6.9 Safety**

- i. Adhere to safety precautions as stated in the Facility Safety manual/ IPC guideline
- ii. All personal protective equipment (PPE) must be worn when performing this procedure.
- iii. All samples must be regarded as potentially infections.

#### **6.6.10 Calibration**

Perform Equipment calibration as scheduled.

#### **6.6.11 Quality Control**

- i. To ensure assay validity, a procedural control bar is incorporated in the assay device.
- ii. Run known positive and negative in-house controls weekly and when the new kit of test strips is opened to verify kit.

#### **6.6.12 Procedure Steps**

- i. Add one drop /40µ pipette LF Sample diluents to an appropriate labeled reservoir. (Test tube) it is also a good practice to label the strip.
- ii. Add 40µ of sample to the reservoir and mix.
- iii. Submerge the white end of a CrAg LF test strip into the sample.
- iv. Wait 10 minutes after inserting the strip
- v. Read and record the results

#### **6.6.13 Biological Reference Intervals**

Not applicable

#### **6.6.14 Interpretation And Reporting Of Results**

##### **Interpretation of results**

##### **Positive Results**

Two red bands appear on the membrane. One band appear on the control region (C) and another band appears on the test region (T)

##### **• Negative Results**

Only one red band appears on the control region C. No apparent red band appears in the test region T.

##### **• Invalid Results**

No visible band at all or there is visible band only in the test region and not in the control region, Repeat the procedure.

##### **Reporting of results**

For the positive result report as **Cryptococcal antigen rapid test Positive**  
For the Negative result report as **Cryptococcal antigen rapid test Negative**

#### **6.6.15 Limitations Of The Procedure And Source Of Error**

- i. The assay Performance Characteristics have not been established for matrices other than serum, plasma, whole blood and CSF
- ii. Depending on the disease and organism prevalence, testing should not be performed as screening procedure for general population. The predictive value of a positive or negative serologic result depends on the pre-test likelihood of cryptococcal disease being present. Testing should only be done when clinical evidence suggests the diagnosis of cryptococcal disease
- iii. Testing hemolyzed serum samples could lead false negatives due to the high background color on the strip
- iv. This assay was not evaluated for potential interference related to sample pre-treatment with 2-mercaptoethanol or with samples including the following substances: Vaginal cream, caffeine, ascorbic acid, itraconazole, amphotericin B, acetaminophen, or acetylsalicylic acid

#### **6.6.16 Performance Characteristics**

Refer to method verification report of this procedure

#### **6.6.17 Supporting Document**

Sample collection manual

#### **6.6.18 References**

## **6.7 PROCEDURE FOR ANTISTREPTOLYSIN - O (ASOT) LATEX SLIDE TEST**

### **6.7.1 Purpose**

This procedure provides instructions for performing Antistreptolysin - O Latex Test.

### **6.7.2 Scope**

This procedure will be used by all staffs in the laboratory.

### **6.7.3 Responsibility**

It is the responsibility of the Head of serology Section to ensure effectively implemented and maintained.

### **6.7.4 Principle**

ASO test method is based on an immunologic reaction between streptococcal exotoxins bound to a biologically polystyrene inert latex particles coated with purified and stabilized streptolysin-O (Antigen) and its corresponding Antistreptolysin -O streptococcal (Antibodies) in the test sample. Visible latex agglutination occurs when increased antibody level is present in the test sample.

### **6.7.5 Sample Requirement**

- 2-3mls fresh serum,

**NOTE 1:** To obtain serum, Centrifuge blood collected in plain red top tube at 3000rpm per 3 minutes

### **6.7.6 Equipment**

Timer, Centrifuge, Refrigerator and Shaker

### **6.7.7 Materials**

ASO Latex Reagents, ASO Positive control, and Negative Control, ASO test card or glass, slide, Disposable gloves, Laboratory coat, Micropipette and Applicator stick

### **6.7.8 Storage and Stability**

Store serum at 2-8°C for up to 7 days. Reagent kits at 2-8°C and are stable until their expiration dates.

### **6.7.9 Safety**

- i. Adhere to safety precautions as stated in the Facility Safety manual/ IPC guideline
- ii. All personal protective equipment (PPE) must be worn when performing this procedure.
- iii. All samples must be regarded as potentially infections.

### **6.7.10 Calibration**

As per equipment calibration schedule.

### **6.7.11 Quality Control**

In-house positive and negative controls are run once a week or before running patient sample

### **6.7.12 Procedure Steps**

- i. Allow all the reagent as well as the sample to reach room temperature
- ii. Using disposable plastic dropper place one drop of the test sample in a circled area of the slide provided in the kit
- iii. Add one drop of ASO latex antigen to the above drop and mix well with the disposable applicator stick
- iv. Rock the slide gently back and forth for two minutes or put on shaker for 1 minute and examine for agglutination do not examine beyond two minutes.
- v. For positive and negative controls follow the same procedure as mentioned above by taking control serum from respective vials

### **6.7.13 Biological Reference Intervals**

Not Applicable

### **6.7.14 Interpretation And Reporting Of Results**

#### **Interpretation of results**

A negative reaction is indicated by a uniform milky suspension with no agglutination as observed with ASO Negative control. A Positive reaction is indicated by any observable agglutination in the reaction mixture. The sample reaction should be compared to the ASO Negative control

#### **Reporting of results**

Report results as “ASOT – Reactive” in the presence of agglutination, or “ASOT – Non reactive” in the absence of agglutination.

### **6.7.15 Limitations Of The Procedure And Source Of Error**

- Results should be read within two minutes after the mixing of the reagent on the slide. A reading obtained after this period of time may be incorrect
- An elevated ASO titre may be observed in condition like acute glomerulonephritis, for sample showing very high titre of ASO in the initial phase successive testing after 10 to 12 days should be carried out.

### **6.7.16 Performance Characteristics**

Refer to method verification report of this procedure

### **6.7.17 Supporting Document**

Sample collection manual

### **6.7.18 References**

- ASOT Test Kit insert: Atlas Medical, ASOT Test Kit “BEACON”



## 6.8 PROCEDURE FOR PERFORMING (HBsAg) RAPID TEST

### 6.8.1 Purpose

The purpose of this procedure is to give instructions on how to perform Hepatitis B Virus Surface Antigen Rapid test in human whole blood, plasma or serum.

### 6.8.2 Scope

This procedure is applicable in all sites that perform Hepatitis B Virus surface antigen in whole blood ,serum or plasma sample qualitatively.

### 6.8.3 Responsibility

It is the responsibility of the Head of serology section and all laboratory personnel to ensure effective implementation of this procedure.

### 6.8.4 Principle

HBsAg is an antibody sandwich immunoassay. Colloidal gold conjugated monoclonal antibody reactive to HBsAg is dry-immobilized onto a nitrocellulose membrane strip. When the sample is added, it migrates by capillary diffusion through the strip rehydrating the gold conjugate. If present, HBsAg will bind with the gold conjugate antibody to form particles. These particles will continue to migrate along the strip until the test zone (T) where they are captured by ant-HBs antibody immobilized there and a visible red line appears. If there is no HBsAg in sample, no red line will appear in the T zone. The gold conjugate will continue to migrate alone until is captured in the control zone (C) by immobilized goat, ant-mouse IgG antibody aggregating a red line, to serve as an internal process control, a control band should always be seen after test is completed. Absence of a colored control line in the control region is an indication of an invalid result.

### 6.8.5 Sample requirements

2-3mls Whole blood, centrifuged Serum or plasma samples

### 6.8.6 Equipment

- i. Timer
- ii. Refrigerator
- iii. Centrifuge

### 6.8.7 Materials

Reagents	Consumables
HBsAg test kits (HBsAg Device, disposable sample droppers)	Disposable gloves, Laboratory coat
Assay diluent	Micropipette

### 6.8.8 Storage And Stability

- a. The test device in the sealed pouch can be stored at 2-40<sup>0</sup>C or as instructed by manufacturer up to the expiration date. The test device must remain in the sealed pouch until use.DD NOT FREEZE.

- b. Store whole blood at 2-8<sup>0</sup>c for up 3 days
- c. Serum and plasma maybe stored at 2-8<sup>0</sup>c for up 7 days, for long term storage, serum and plasma samples should be kept at-20<sup>0</sup>c or below.

### **6.8.9 Safety**

- i. Adhere to safety precautions as stated in the Facility Safety manual/ IPC guideline
- ii. All personal protective equipment (PPE) must be worn when performing this procedure.
- iii. All samples must be regarded as potentially infections.

### **6.8.10 Calibration**

Perform Equipment calibration as scheduled.

### **6.8.11 Quality Control**

Run known Negative and Positive in-house controls once a week or when new test kit is opened .

### **6.8.12 Procedure Steps**

- i. Remove the test strip from foil pouch and use as soon as possible.  
**Note: Check and verify the device's integrity before and after opening the foil pouch**
- ii. Label the test device with patient ID  
**Whole blood sample:**
- iii. Hold the dropper vertically and transfer 2 drops of whole blood (approximately 50-60 ul) to the sample area, then add one drop of buffer  
**Serum/ plasma;**
- i. Immerse the strip into the sample tube with the arrow end pointing towards the sample.
- ii. Let it stay immersed until you see liquid traveling up past the MAX word.
- iii. Lay the strip (MAX side facing up) flat on a clean, dry, non-absorbent surface
- iv. If cassette; Add 60µl (2 drop) of serum or plasma in to the sample window and allow to soak in.
- v. Read the results at 15-20 minutes. Ensure that the background of the test area is white before interpreting the results

### **6.8.13 Biological Reference Intervals**

Not Applicable

### **6.8.14 Interpretation And Reporting Of Results**

#### **14.1 Interpretation Of Results**

**NEGATIVE:** if only one line (control line) appears in result line area, interpret the result as negative. This shows that the concentration of HBsAg in the sample is under the detection limit.

**POSITIVE:** if only two line (control line and test) appears in result line area, interpret the result as positive.

**INVALID:** Control line fails to appear. Insufficient sample volume or incorrect procedural technique is the most likely reasons for control line failure. Review the procedure and repeat the test with a new test strip.

#### **Reporting of results**

Reactive test Results. Report as HBsAg rapid test positive

Non-reactive test results: Report as HBsAg rapid test negative

#### **6.8.15 Limitations Of Procedure And Source Of Error**

- i. HBsAg Rapid Test Kit detects HBsAg in human serum or plasma and is only screening test. All reactive samples should be confirmed by supplemental assays like PCR OR ELISA.
- ii. A non -reactive result does not exclude the possibility of exposure or infection with Hepatitis B virus.
- iii. Patients with auto-immune liver diseases may show falsely reactive results.
- iv. This test is standardized to work best when the test procedure mentioned in the package insert is strictly followed. Any deviation from the test procedure may lead to erroneous results.

#### **6.8.16 Performance Characteristics**

Refer to method verification report of this procedure

#### **6.8.17 Supporting Documents**

Sample collection manual

#### **6.8.18 References**

HBsAg Package insert kit

## **6.9 PROCEDURE FOR SARS-COV-2 ANTIGEN RAPID DIAGNOSTIC TEST**

### **6.9.1 Purpose**

The purpose of this standard operating procedure (SOP) is to provide guidelines to be followed for performing Rapid Antigen Detection Test for COVID-19 using the Standard COVID-19 Ag detection assay kit

### **6.9.2 Scope**

This procedure is to be performed at point of care or any health facility

### **6.9.3 Responsibility**

The Head of Serology is responsible for ensuring the effective implementation and maintenance of this procedure

Qualified, competent and registered Medical Laboratory practitioners are responsible for implementing this test procedure.

### **6.9.4 Principle**

It is a rapid chromatographic immunoassay for qualitative detection of specific antigens to SARS-CoV-2. When the liquid sample is dropped on the sample pad, the antigen in the sample forms an immunocomplex with the antibody labelled with colloidal gold. Its complex moves along with the liquid sample, and makes a contact with the antibody immobilized on the membrane, followed by forming an immunocomplex with the immobilized antibody, resulting in generation of a coloured red purple line. Appearance of red purple line on the membrane indicates the presence of antigen in the sample. Since the liquid of the sample migrates through the membrane very fast, it makes it possible to detect the presence or absence of antigen within 15 minutes.

### **6.9.5 Sample Requirements**

Nasopharyngeal swab sample collected from nostril of the suspect individual.

Oropharyngeal swab sample collected from the posterior pharynx and tonsillar area of the suspect individual.

### **6.9.6 Equipment**

Stop watch, Micropipette/Supplied capillary

### **6.9.7 Materials**

<b>Reagent</b>	<b>Consumables</b>
Test devices Buffer	Disposable gloves Laboratory coat 70% alcohol Mask

### **6.9.8 Storage And Stability**

Store Covid 19 rapid kit device 2-30°C Protected from sunlight and should not be frozen

### **6.9.9 Safety**

- i. Adhere to safety precautions as stated in the facility Safety manual
- ii. All personal protective equipment (PPE) must be worn when performing this procedure.
- iii. All samples must be regarded as potentially infectious.
- iv. Refer to National infection prevention and control Guidelines for health waste **management and safety practice.**

### **6.9.10 Calibration**

Perform equipment calibration as per schedule

### **6.9.11 Quality Control**

Run known Negative and Positive in-house controls once a week.

The test strips contain a control line, which turns coloured if the run is valid.

### **6.9.12 Procedural Steps**

- i. Peel off the aluminium foil seal from the sample processing tube containing the extraction buffer.
- ii. After the sample collection, plunge the swab up and down in the sample processing tube for at least 15 seconds, taking care not to spill the contents out of the tube.
- iii. Remove the swab while pinching wall of the tube with the swab and rotating the swab, to extract the liquid from the swab.
- iv. Firmly attach the dropper lid to the top of the sample processing tube.
- v. Remove the test cassette from the sealed pouch.
- vi. Sample adding: Reverse the sample processing tube, holding the tube upright, and slowly add 3-4 drops to the sample ole (S) of the test cassette then start the timer.
- vii. Timing observation: judge the result 15 minutes after sample adding; do not observe the results after 30 minutes later.
- viii. After the test, put the medical wastes into the biosafety bag.

### **6.9.13 Biological Reference Interval**

Not Applicable

### **6.9.14 Interpretation and Reporting of Results**

#### **Results interpretation**

**A Positive:** Two distinct coloured bands appear on the strip.

**Negative:** Only one distinct coloured band on the strip.

**Invalid:** If no control band is seen.

#### **Reporting of results**

Report negative results as SARS-COV-2 – Negative.

Report positive result as SARS-COV-2 – Positive

#### **Critical value**

Any positive results

#### **6.9.15 Limitation of the Procedure and Sources of Error**

- i. The kit is not intended for testing liquid sample such as wash or aspirate sample or swab in transport media as a result can be compromised by over dilution.
- ii. Insufficient sample volume or incorrect procedural techniques are the most likely reason for control line failure

#### **6.9.16 Performance Characteristics**

Refer manufacturer reagent kit insert for sensitivity and specificity

#### **6.9.17 Supporting Documents**

- **Sample collection manual**

#### **6.9.18 References**

- Manufacture package insert kit for SARS COV-2

ASOT Test Kit insert:

Atlas Medical,

## **6.10 PROCEDURE FOR DENGUE VIRUS ANTIBODY DETECTION RAPID TEST**

### **6.10.1 Purpose**

This procedure provides details instruction for screening of dengue IgG, IgM antibody by using rapid test strip as an aid in the diagnosis of infection with Dengue virus

### **6.10.2 Scope**

This procedure is used in serology section when performing rapid *Dengue* antibody rapid tests.

### **6.10.3 Responsibility**

Qualified, trained and competent health laboratory practitioners are responsible for implementing this test procedure.

The Head serology is responsible for ensuring the effective implementation and maintenance of this procedure.

### **6.10.4 Principle**

Dengue test utilizes immunochromatography whereby mouse anti- human IgM and human IgG antibodies are immobilized on the nitrocellulose membrane respectively, as two individual test lines (IgM line and IgG line) in the test window of the test device. The IgG line in the test window is closer to the sample well and followed by IgM line. As the test sample flows through the membrane within the test device, the coloured-dengue specific recombinant antigen-colloidal gold conjugate complexes with specific antibodies (IgM and or IgG) of dengue virus if present in the sample. This complex moves further on the membrane to the test region where it is captured by the anti-human IgM and or human IgG antibodies coated on the membrane leading to formation of a coated band, which indicates a positive test results. Absence of the coloured band in the test window indicates a negative test result. A built in control line will always appear in the test window when the test has performed properly regardless of the presence or absence of anti-Dengue virus antibodies in the sample.

Dengue NSI antigen test is a solid phase immunochromatographic assay. As the test sample flows through the membrane within the test device and mobilize the gold anti-NSI conjugate that it is coated on the conjugate pad if NSI it is present then the result it is the formation of coloured band of the test (T)line region

### **6.10.5 Sample Requirements**

Plasma/whole blood, Serum (2-5ml)

**NOTE 1:** To obtain serum, Centrifuge blood collected in plain red top tube at 3000rpm/RCF per 3 minutes

**NOTE 2:** To obtain Plasma, Centrifuge blood collected in EDTA tube at 3000rpm/RCF per 3 minutes

### 6.10.6 Equipment

Timer ,Centrifuge ,refrigerator and Thermometer

### 6.10.7 Materials

Reagents	consumables
<ul style="list-style-type: none"><li>• Dengue IgG/IgM antibody and NSI antigen Cassette</li><li>• Buffer</li><li>• Transfer pipette for dengue NSI</li><li>• Capillary pipette for Dengue IgG/IgM</li><li>• Known Positive control,</li><li>• Known Negative control</li></ul>	<ul style="list-style-type: none"><li>• Marker pen</li><li>• Examination Gloves</li><li>• Gauze</li></ul>

### 6.10.8 Storage and Stability

- The test kit should be stored at 15-25°C in the sealed pouch for the duration of the shelf-life (refer to manufacturer instruction)
- If the samples are not to be tested they should be refrigerated immediately at 4 - 8 °C
- If storage periods > 5 days the sample should be frozen at -20°C

### 6.10.9 Safety

- Adhere to safety precautions as stated in the Safety manual/IPC guideline
- All personal protective equipment (PPE) must be worn when performing this procedure.
- All samples must be regarded as potentially infections.

### 6.10.10 Calibration

Perform calibration of equipment (Timer ,Centrifuge ,refrigerator and Thermometer)as per calibration schedule

### 6.10.11 Quality Control

- Control samples weather commercial or in-house made are run the same way as patient sample on weekly bases and whenever a new kit is opened.
- Serology Section head should review Quality control records

### 6.10.12 Procedural Steps

- Bring the samples and the test components to room temperature if refrigerated or frozen. Mix the sample well prior to assay
- Remove the test strip from the foil pouch and use it as soon as possible
- Use transfer pipette to transfer sample by depressing the bulb of the pipette
- If capillary used withdraw 5ul of sample, the black bar near the opening end of pipette indicates the required 5ul of sample.
- Drop the sample in the corner pointed by S1»
- Hold the pipette in a vertical position over the left “S” sample well on the device



- vii. Transfer 2 drops of sample into well
- viii. Dispense 2 drops of sample buffer to the right "S" sample well
- ix. Read result at the end of 20 minutes

#### **6.10.13 Biological Reference Interval**

Not Applicable

#### **6.10.14 Interpretation and Reporting of Results**

**Interpretation of results**

##### **NEGATIVE**

- If only the "C" line is developed, the test indicates that no detectable antibodies to dengue are present in the sample

##### **POSITIVE**

- Lines showed to control and NSI –NS1 POSITIVE during window period
- Lines showed to control and IGM-IgM Positive Chronic dengue
- Lines Showed to control and IgG- IgG Positive during early infections BUT has been treated

##### **INVALID**

If NO line is developed at "C", the assay is invalid regardless of colour development on the "T" line. Repeat the test

##### **Reporting of results**

Report results as: *Dengue* - Negative or *Dengue* – Positive

##### **Critical value**

Positive findings

#### **6.10.15 Limitation of the Procedure and Sources of Error**

This kit is intended ONLY for testing of individual samples. Don't use it for testing of cadaver samples, saliva, urine or other blood samples or pooled (mixed) blood

#### **6.10.16 Performance Characteristics**

Refer manufacture kit insert for specificity and sensitivity. Also Method verification of this procedure should be done and that the report should be referred to verify compliance to this requirement. for Dengue rapid test procedure

#### **6.10.17 Supporting Documents**

Sample collection manual

#### **6.10.18 References**

Dengue IgG/IgM antibody + NSI antigen Cassette Test Rapid Test Strip Package insert.

## 6.11 PROCEDURE FOR PLAGUE RAPID TEST

### 6.11.1 Purpose

This procedure provides details instruction of detecting acute bacterial infection caused by *Yersinia pestis*

### 6.11.2 Scope

This procedure is used in serology section when performing rapid *Plague* rapid tests(F1RDT)

### 6.11.3 Responsibility

Qualified, trained and competent health laboratory practitioners are responsible for implementing this test procedure.

The Head serology is responsible for ensuring the effective implementation and maintenance of this procedure.

### 6.11.4 Principle

F1RDT detect pathogen-specific antigens (the F1 capsular antigen, which is part of the outer surface of *Yersinia pestis*, the bacteria causing plague) in a small quantity of different body fluids through lateral flow immunochromatography. The test is simple to perform and provides a result within 15 minutes. It can be performed in the pus contained in the buboes (swellings), or in the sputum (mucous coughed up from the respiratory tract) of people with suspected pneumonic plague.

### 6.11.5 Sample Requirements

Bubo aspirate, urine, and sputum,serum

### 6.11.6 Equipment

Centrifuge, timer, thermometer

### 6.11.7 Materials

Reagents	Consumables
F1RDT test kit	<ul style="list-style-type: none"><li>• Marker pen</li><li>• Examination Gloves</li><li>• Gauze</li></ul>

### 6.11.8 Storage and Stability

Refer to manufacturer storage instructions of test devices and samples

### 6.11.9 Safety

- Adhere to safety precautions as stated in the Safety manual/IPC guideline
- All personal protective equipment (PPE) must be worn when performing this procedure.
- All samples must be regarded as potentially infections.

### 6.11.10 Calibration

Perform calibration of equipment (Timer ,Centrifuge and Thermometer)as per calibration schedule

**6.11.11 Quality Control**

Refer to manufacturer insert package

**6.11.12 Procedural Steps**

Refer to manufacturer insert package

**6.11.13 Biological Reference Interval**

Not Applicable

**6.11.14 Interpretation and Reporting of Results**

**Interpretation** of results

Refer to manufacturer insert package

**Reporting of results**

Report results as: *Plague* - Negative or *Plague* – Positive

Critical value

Positive findings

**6.11.15 Limitation of the Procedure and Sources of Error**

F1RTD test needs to be combined with other laboratory evaluations to confirm the diagnosis

**6.11.16 Performance Characteristics**

Method verification of this procedure should be done and that the report should be referred to verify compliance to this requirement. of this procedure

**6.11.17 Supporting Documents**

Sample collection manual

**6.11.18 References**

Chanteau S, Rahalison L, Ratsitorahina M, Mahafaly, Rasolomaharo M, Boisier P, et al. Early diagnosis of bubonic plague using F1 antigen capture ELISA assay and rapid immunogold dipstick. *International Journal of Medical Microbiology* 2000;290(3):279-83.

## 6.12 PROCEDURE FOR *Helicobacter Pylori* ANTIGEN TEST

### 6.12.1 Purpose

This procedure provides instructions for the rapid detection of *Helicobacter pylori* antigen in human stool sample.

### 6.12.2 Scope

This procedure is used in serology section to all rapid *H. pylori* antigen tests.

### 6.12.3 Responsibility

Qualified, trained, and competent health laboratory practitioners are responsible for implementing this test procedure.

The Head serology is responsible for ensuring the effective implementation and maintenance of this procedure.

### 6.12.4 Principle

This is a ready to use test that is based on the homogeneous membrane system technology with latex microspores to perform the test, an aliquot of diluent sample is added to sample well of the test cassette. The sample flows through a label pad containing Pylori antibody coupled to red –colored colloidal gold. In the presence of antigens, they bind to the antibody coated on the colloidal gold particles to form antigen-antibody-gold complexes. These complex moves on the nitrocellulose membrane by capillary action towards the test line region on which Pylori specific to the antibody on the membrane in the form of a line. A second red control line will always appear in the results windows to indicate that the test has been correctly performed and the test device functions properly. If pylori is not present or lower than the detection limit of the test, only the control line will be visible. If the control line does not develop, the test is invalid.

### 6.12.5 Sample Requirements

Stool sample.

### 6.12.6 Equipment

Timer

### 6.12.7 Materials

Reagents	consumables
Test cassette dilution buffer -Known Positive control, -Known Negative control	Marker pen Examination Gloves

### 6.12.8 Storage and Stability

- I. Store un opened test device at 2- 30 °C. if stored at 2-8 °C, ensure that the test device is brought to room temperature before opening. Do not freeze the kit or expose the kit over 30 °C. (refer to manufacturer instruction)
- II. Store sample at 2-8 °C for up to 72 hours.

### **6.12.9 Safety**

- i. Adhere to safety precautions as stated in the Safety manual/IPC guideline
- ii. All personal protective equipment (PPE) must be worn when performing this procedure.
- iii. All samples must be regarded as potentially infectious.

### **6.12.10 Calibration**

Perform calibration of equipment as per calibration schedule

### **6.12.11 Quality Control**

Analyse known Negative and Positive in-house controls once every week and whenever a new kit is opened.

### **6.12.12 Procedural Steps**

- i. Remove the test device from its foil pouch by tearing along the notch and use as soon as possible
- ii. Unscrew the cap of the sample collection tube.
- iii. Randomly stab the sample collection stick into the fecal sample at list 6 different sites
- iv. Return the sample collection stick into the sample tube and tighten the cap
- v. Shake the sample collection tube vigorously to mix the sample and the extraction buffer
- vi. Hold the sample collection tube upright and break off the tip of the sample collection tube, invert the sample collection tube and transfer two drops of the mixture into the sample pad of the test strip then start timer
- vii. Wait 10-15 minutes and read the results for the colored lines to appear
- viii. Do not read result after 15 minutes

### **6.12.13 Biological Reference Interval**

Not Applicable

### **6.12.14 Interpretation and Reporting of Results**

#### **Interpretation of results**

Negative - Only one coloured band appears on the control(C) region. No apparent band on the test(T) region

Positive - In addition to a pink coloured control (C) band, a distinct pink coloured band will also appear in the tests(T) region

Invalid – a total absence of colour in both regions or no coloured line appears on the control (C) region is an indication of procedure error or the tests deterioration. Repeat the test with a new kit.

#### **Reporting of results**

Report results as: H pylori - Negative or H pylori – Positive

### **6.12.15 Limitation of the Procedure and Sources of Error**

- i. The test is a qualitative assay and is not for quantitative determination of antibodies concentration levels in human stool only

- ii. The results obtained should only be interpreted in conjunction with other diagnostic results and clinical information.
- iii. A negative result can occur if the quantity of the Pylori antigen presence in the sample below the detection limits of the assay, or the antigen that are detected are not present during the stage of diseases in which a sample is collection.

**6.12.16      *Performance Characteristics***

Refer manufacture kit insert for specificity and sensitivity. Also Method verification of this procedure should be done and that the report should be referred to verify compliance to this requirement for H pylori procedure

**6.12.17      *Supporting Documents***

Sample collection manual

**6.12.18      *References***

Manufacturer Kit insert for H pylori

## 6.13 PROCEDURE FOR HELICOBACTER PYLORI ANTIBODY RAPID TEST

### 6.13.1 Purpose

Rapid chromatographic immunoassay for the qualitative detection of antibodies (IgG) anti-Helicobacter pylori (*H. pylori*) in human serum or plasma. It is used as an aid in the diagnosis of infection with *H. pylori*

### 6.13.2 Scope

This procedure is used in serology section when performing rapid *H. pylori* antibody tests.

### 6.13.3 Responsibility

Qualified, trained and competent health laboratory practitioners are responsible for implementing this test procedure.

The Head serology is responsible for ensuring the effective implementation and maintenance of this procedure.

### 6.13.4 Principle

The *H. Pylori* rapid Test device is a lateral flow chromatographic assay based on the Principle of the antibody – sandwich technique. The membrane is pre coated with *H.pylori* Antigen on the test line region of the test. During testing *H. pylori* Antibodies in the serum or plasma sample reacts with coated antigen and migrates upward on the membrane chromatography by capillary action to the membrane and generate a colored line. The presence of this colored line in the test region indicates a positive result, while its absence indicates a negative result

### 6.13.5 Sample Requirements

Plasma/whole blood, Serum (2-5ml)

**NOTE 1:** To obtain serum, Centrifuge blood collected in plain red top tube at 3000rpm per 3 minutes

**NOTE 2:** To obtain Plasma, Centrifuge blood collected in EDTA tube at 3000rpm per 3 minutes

### 6.13.6 Equipment

Timer, Centrifuge, refrigerator and Thermometer

### 6.13.7 Materials

Reagents	consumables
Test cassette/strips buffer -Known Positive control, -Known Negative control	Marker pen Examination Gloves

### 6.13.8 Storage and Stability

- III. Store unopened test device at 2- 30 °C. If stored at 2-8 °C, ensure that the test device is brought to room temperature before opening. Do not freeze the kit or expose the kit over 30 °C. (refer to manufacturer instruction)
- IV. Store sample at 2-8 °C for up to 72 hours.

#### **6.13.9 Safety**

- iv. Adhere to safety precautions as stated in the Safety manual/IPC guideline
- v. All personal protective equipment (PPE) must be worn when performing this procedure.
- vi. All samples must be regarded as potentially infectious.

#### **6.13.10 Calibration**

Perform calibration of equipment (Timer, Centrifuge, refrigerator and Thermometer) as per calibration schedule

#### **6.13.11 Quality Control**

- i. Analyse known Negative and Positive in-house controls the same way as sample testing procedure once every week and whenever a new kit is opened.
- ii. Serology Section head should review Quality control records

#### **6.13.12 Procedural Steps**

- i. Remove the test device from its foil pouch by tearing along the notch and use as soon as possible
- ii. Place the test strip on a clean and level surface, hold the dropper vertically and transfer 1 drop of plasma/serum to the sample pad.
- iii. Add 1 drop of buffer, then start the timer
- iv. Read the results in 10-15 minutes

#### **6.13.13 Biological Reference Interval**

Not Applicable

#### **6.13.14 Interpretation and Reporting of Results**

##### **14.1 Interpretation of results**

Negative - Only one coloured band appears on the control(C) region. No apparent band on the test(T) region

Positive - In addition to a pink coloured control (C) band, a distinct pink coloured band will also appear in the tests(T) region

Invalid – a total absence of colour in both regions or no coloured line appears on the control (C) region is an indication of procedure error or the tests deterioration. Repeat the test with a new kit.

##### **14.2 Reporting of results**

Report results as: *H pylori* - Negative or *H pylori* – Positive

##### **14.3 Critical value**

Not applicable

#### **6.13.15 Limitation of the Procedure and Sources of Error**



- The test is for in vitro diagnostic use only
- The test should not be used as the sole criteria for the diagnosis of pylori infection since it only indicates the presence of antibodies in the sample

#### **6.13.16      *Performance Characteristics***

Refer manufacture kit insert for specificity and sensitivity. Also Method verification of this procedure should be done and that the report should be referred to verify compliance to this requirement. for H. pylori procedure

#### **6.13.17      *Supporting Documents***

Sample collection manual

#### **6.13.18      *References***

Manufacturer Kit insert for H pylori

## **6.14 PROCEDURE FOR BRUCELLA ANTIBODY DETECTION**

### **6.14.1 Purpose**

This procedure provides instructions for Qualitative detection of antibodies of all isotopes against Brucella species.

### **6.14.2 Scope**

The procedure is used in the serology section in the diagnosis of brucellosis.

### **6.14.3 Responsibility**

Qualified, registered and competent health laboratory practitioners are responsible for implementing this test procedure. Section heads are responsible for ensuring the effective implementation and maintenance of this procedure.

### **6.14.4 Principle**

This test is based on antigen /antibody reaction. The smooth, attenuated stained Eurocell antigen suspensions are mixed with the patient's serum. Specific antibodies to Brucella antigens if present in the patient serum will react with the antigen suspensions to produce an agglutination reaction. No agglutination indicates the absence of specific antibodies to Brucella antigens.

### **6.14.5 Sample Requirement**

Serum sample is preferable for this procedure. Allow blood to clot and Centrifuge the sample at 3000rpm for 5 minutes

### **6.14.6 Equipment**

Centrifuge, Pipettes, Shaker and Stop watch

### **6.14.7 Materials**

Stained Eurocell-A/ Eurocell -M Antigen suspensions, Slide Test, 70% alcohol, Known Positive control, Known Negative control, Marker pen, Examination Gloves.

### **6.14.8 Storage and Stability**

Reagent should be stored at 2-8°C. Sample can be stored at room temperature for 4hrs then can be stored at 2-8°C If serum separated can be stored at -20°C for 1year.

### **6.14.9 Safety**

- i. Adhere to safety precautions as stated in the facility Safety manual
- ii. All personal protective equipment (PPE) must be worn when performing this procedure.
- iii. All samples must be regarded as potentially infections.
- iv. Refer to National infection prevention and control Guidelines for health care services in Tanzania

### **6.14.10 Calibration**

Calibration of Centrifuge should be done as per schedule.

### **Maintenance**

Maintenance of Centrifuge should be done as planned.

#### **6.14.11 Quality Control**

Run the positive and negative controls sample daily before performing patient samples or run QC Parallel with patient sample.

#### **6.14.12 Procedural Steps**

- i. Prior to the start bring all reagents to room temperature (20 to 25°C).
- ii. Shake and mix the Eurocell antigen suspension well before dispensing.
- iii. Place one drop of positive and negative control onto the reaction circle of glass slide.
- iv. Place 80ul of saline onto the next reaction circle of the glass slide.
- v. Place 80ul of patient serum to be tested onto the next reaction circle.
- vi. Add one drop of the appropriate Eurocell antigen suspensions in each of the above circles.
- vii. Mix contents of each circle uniformly over the entire circle with separate mixing sticks.
- viii. Gently rock the slide back and forth/observe for agglutination macroscopically for one minute

#### **6.14.13 Biological Reference Interval**

Not applicable

#### **6.14.14 Interpretation and Reporting of Results**

Agglutination is a **POSITIVE** test results and indicates the presence of specific antibodies to Brucella in the patient's serum. No agglutination is a **NEGATIVE** test results

##### **Reporting of results**

Report results as Brucella antibody – NEGATIVE or Brucella antibody – POSITIVE

#### **6.14.15 Limitation of the Procedure and Sources of Error**

The test cannot distinguish between past infection and current infection

#### **6.14.16 Performance Characteristics**

Refer to the verification report of this procedure

#### **6.14.17 Supporting Document**

Result management procedure

#### **6.14.18 References**

Monica Cheesbrough: District Laboratory Practice in Tropical Countries, Vol 1, Tropical Health Technology, 1998.

URIT 560 Urine Analyzer– User Manual for Urine Chemistry Analyzer

Practical Laboratory Manual-Jane Carter and Orgenes Lema

## **6.15 PROCEDURE FOR SALMONELLA TYPHI ANTIBODIES QUANTIFICATION METHOD**

### **6.15.1 Purpose**

This procedure provides instructions for in vitro detection and quantitative estimation of specific antibodies to salmonella present in Human serum

### **6.15.2 Scope**

The procedure is used in serology section when performing widal test by slide method.

### **6.15.3 Responsibility**

Qualified full registered and competent laboratory practitioners are responsible for implementing this test procedure.

The Head of serology section is responsible for ensuring the effective implementation and maintenance of this procedure.

### **6.15.4 Principle**

This test is based on the Principle of direct agglutination reaction. The smooth suspension of killed salmonella bacilli carries homologous O and H antigens. When patient serum (containing antibodies to *S typhi* and *S paratyphi*) is incubated with respective antigens, visible agglutination occurs. Arising titre of antibodies is indicative of Enteric fever

### **6.15.5 Sample Requirements**

Serum sample is preferable for this procedure. Allow blood to clot  
Centrifuge the sample at 3000rpm for 5 minutes

### **6.15.6 Equipment**

Timer, Centrifuge, Pipettes, Water bath

### **6.15.7 Materials**

Stained salmonella antigen set, Stained salmonella antigen S typhi "O", Stained salmonella antigen S typhi "H", Disposable gloves, pipettes, White Tile or slide, Sample rack, Test tube rack, 5% Sodium hypochlorite to wipe and disinfect the spills and Marker Pen

### **6.15.8 Storage and Stability**

Reagent should be stored at 2-8°C

Sample can be stored at room temperature for 4hrs then can be stored at 2-8°C if serum separated can be stored at -20°C for 1year.

### **6.15.9 Safety**

- i. Decontaminate working surfaces twice daily, in the morning and afternoon
- ii.
- iii. Adhere to safety precautions as stated in the facility Safety manual

- iv. All personal protective equipment (PPE) must be worn when performing this procedure.
- v. All samples must be regarded as potentially infectious.
- vi. Refer to National infection prevention and control Guidelines for health care services in Tanzania,

**6.15.10 Calibration**

Centrifuge should be calibrated as per schedule.

**1.1. Maintenance**

Maintenance of Centrifuge should be done as planned

**6.15.11 Quality Control**

Analyze the positive and negative controls sample daily before performing patient samples or run QC Parallel with patient sample.

**6.15.12 Procedural Steps**

**Rapid slide test (Widal screening test)**

- i. Clean the glass slide or white tile provided in the kit and wipe
- ii. Place 1 drop of undiluted serum to be tested in each of the first two circle (1-2)
- iii. Add one drop of antigen “O” and “H” in circles 1,2 respectively
- iv. Mix the contents of each circle with separate stick and spread to fill the entire circle area
- v. Rock the slide for one minute and observe for agglutination
- vi. If agglutination is visible within one minute then proceed for quantitative estimation

**Quantitative slide/white tile test**

<b>Circle</b>	<b>Serum Volume</b>	<b>Appropriate Antigen Drop</b>		<b>Titre</b>
01	0.08ml	1 drop	Mix and Rotate for one minute and observed agglutination	1:20
02	0.04ml	1 drop		1:40
03	0.02ml	1 drop		1:80
04	0.01ml	1 drop		1:160
05	0.005ml	1 drop		1:320

**6.15.13 Biological Reference Interval**

- When value of O and H antigen are less than 1:160 NEGATIVE
- When value of O and H antigen are greater than 1:160 POSITIVE

**6.15.14 Interpretation And Reporting Of Results**

- i. Salmonella typhi O: 1:(Respective titre)
- ii. Salmonella typhi H: 1 :(Respective titre)

**Rapid/ white tile widal test**

Granular agglutination in case of “O” and flocculating agglutination in case of “H” indicate positive reaction

**Quantitative slide/white tile test**

A diagnostic titre of 1:80 suggest positive results

**6.15.15      *Limitation of the Procedure and Sources of Error***

Rapid slide tests or quantitative slide tests are non-specific type of test. The positive results should be further confirmed by tube test and other microbiological investigations

**6.15.16      *Performance Characteristics***

Refer data for verification report

**6.15.17      *Supporting Documents***

Not applicable

**6.15.18      *References***

Reagent package insert for widal test

## **6.16 PROCEDURE FOR RHEUMATOID FACTOR TEST**

### **6.16.1 Purpose**

This procedure provides instructions for performing Qualitative determination of Rheumatoid Factor

### **6.16.2 Scope**

The procedure is used for performing Qualitative determination of Rheumatoid Factor at serology section

### **6.16.3 Responsibility**

Qualified and competent Assistant Medical Laboratory Practitioners are responsible for **implementing this procedure**

### **6.16.4 Principle**

Rheumatoid Factor is based upon the agglutination reaction between Rheumatoid Factor (RF) of a patient Sample or control serum and human immunoglobulin G (Ig G) coated onto polystyrene latex particles. The positive reaction is indicated by a distinctly visible agglutination of the latex particles in the test cell of the slide.

### **6.16.5 Sample Requirements**

Serum collected from blood in plain tube (Red top) and centrifuged at 3000 rpm for 5 minutes

### **6.16.6 Equipment**

Centrifuge and Shaker (automated rotator)

### **6.16.7 Materials**

- RF latex reagent (white cap)
- Positive Control serum (red cap)
- Negative Control serum (green cap)

### **Supplies**

- Disposable Gloves
- Micropipette
- Timer/stop watch
- Slide/ opaque tile

### **6.16.8 Storage and Stability**

Serum; stability: up to 24 hours at 2-8<sup>0</sup> C, and up to 4 weeks at -20<sup>0</sup> c

Reagents storage: 2 – 8 <sup>0</sup> C

### **6.16.9 Safety**

- All personal protective equipment (PPE) must be worn when performing this procedure.
- All Samples must be regarded as potentially infections.



- Refer to National infection prevention and control Guidelines for health waste management and safety practice

#### **6.16.10 Calibration**

- Auxilliary equipment should be calibrated annually performed by TBS as per schedule

#### **6.16.11 Quality Control**

- Positive control and Negative control are to be used with each series. Their results should be compared with the unknown Sample to distinguish possible granularity from agglutination.
- **Positive control** –distinct agglutination within 2 minutes
- **Negative control** – smooth suspension with no visible agglutination after 2 minutes

#### **6.16.12 Procedural Steps**

- a. Bring latex reagent, controls and serum samples to room temperature.
- b. Place 1 drop (40ul) serum sample/controls onto respectively separate cells of the card.
- c. Add 1 drop of latex reagent
- d. Mix with separate sticks and spread the fluid over the entire area of the particular cell.
- e. Tilt the slide back and forth for 2 minutes.
- f. At the end of the 2 minutes read the results under bright light.

#### **6.16.13 Biological Reference Intervals**

Not applicable.

#### **6.16.14 Interpretation And Reporting Of Results**

- Distinct agglutination indicates a RF content of more than 20IU/ml in the non-diluted serum Sample.
- Sera with positive results in the screening test should be re-tested in the titration test

#### **6.16.15 Limitations Of The Procedure And Sources Of Error**

Do not use kit beyond the expiration date which appears on the package label or device in a damage pouch. Use only clear, non-hemolyzed sample

#### **6.16.16 Performance Characteristics**

Refer to method verification report

#### **6.16.17 Supporting Documents**

Sample collection manual and safety manual

#### **6.16.18 References**

Manufactures User manual

## 6.17 PROCEDURE FOR CONFIRMATION OF TREPONEMA PALIDUM BY TREPONEMA PALLIDUM HAEMAGGLUTINATION ANTIGEN (TPHA)

### 6.17.1 Purpose

This procedure provides instructions for Qualitative detection of antibodies of all isotopes against *Treponema pallidum* using the haemagglutination technique

### 6.17.2 Scope

The procedure is used in the serology section as a confirmatory test in the diagnosis of syphilis infection

### 6.17.3 Responsibility

Qualified and trained Medical Laboratory Technicians, Technologists and Scientist are responsible for implementing this test procedure.

The Head serology is responsible for ensuring the effective implementation and maintenance of this procedure.

### 6.17.4 Principle

The TPHA kit uses preserved avian erythrocytes coated with antigens of *Treponema pallidum* to bind with specific antibodies present in patient serum or plasma. The cells are suspended in diluent containing components to eliminate nonspecific reactions. Positive reactions are characterized by agglutination of the cells while negative reactions by the setting of the cells to button or small ring

### 6.17.5 Sample Requirements

Type of sample required is Blood. Sample Preparation should be Centrifuged at 3000rpm for 5 minutes and serum or Plasma should be aspirated

### 6.17.6 Equipment

Centrifuge, Timer and micropipette

### 6.17.7 Materials

Reagent	Consumables
Sample diluent	Test cells
Control cells	Marker pen
Kit Positive control	Examination Gloves
Kit Negative control	Timer
	Microplate U shaped-wells
	Microplate cover

### 6.17.8 Storage and Stability

Sample should be stored at 2-8°C but if stored for longer period should be frozen at -20°C

### **6.17.9 Safety**

- i. Adhere to safety precautions as stated in the Safety manual
- ii. All personal protective equipment (PPE) must be worn when performing this procedure.
- iii. All samples must be regarded as potentially infectious.
- iv. Refer to National infection prevention and control Guidelines for health waste management and safety practice.
- v. All spills should be wiped thoroughly using 1% sodium hypochlorite solution.
- vi. Handle all sample as if they contain infectious agents, observe established precautions against microbiological hazards throughout testing and follow the standard procedures for proper disposal of samples
- vii. Wear protection clothing such as a laboratory coat, disposable gloves when samples are being tested.

### **6.17.10 Calibration**

Not Applicable

### **6.17.11 Quality Control**

Analyse the positive and negative controls supplied with test kit with each batch of patient samples.

For Semi-quantitative assay, the positive control must give a titre which is in the range 640 – 2560

### **6.17.12 Procedural Steps**

#### **Quantitative techniques**

- i. Bring all reagents to room temperature prior to use
- ii. Dilute sample {1/20} by adding 190ul of TPHA diluent and 10µl of the sample to a well.
- iii. Thoroughly mix the sample and diluent
- iv. Dilute Negative and Positive controls in the same manner as patient sample in steps 2 and 3 above and likewise treat them like the sample as given in steps below.
- v. Add 25µl of diluted sample to each of the two wells
- vi. Gently mix Test cells and controls cells to ensure thorough re-suspension
- vii. Add 75µl of Test cells to first well containing diluted patient cells and ensure thorough mixing
- viii. Add 75µl of control cells to second well containing diluted patient cells and ensure thorough mixing

**NOTE:** Final sample dilution after addition of cells is 1/80

- ix. Incubate at room temperature {15-30°C} on a vibration free surface for a minimum of 45minutes {60 minutes may be necessary for optimum results with some plate readers}
- x. Read and interpret the setting pattern, Agglutination pattern are stable for at least 3 hours if undisturbed.

### **Qualitative Assay**

- i. Bring all reagents to room temperature prior to use
- ii. Dilute sample {1/20} by adding 190 µl of TPHA diluent and 10µl of the sample to a well.
- iii. Thoroughly mix the sample and diluent
- iv. Dilute Negative and Positive controls in the same manner as patient sample in steps 2 and 3 above and likewise treat them like the sample as given in steps below.
- v. Add 25µl of diluted sample to each of the two wells
- vi. Gently mix Test cells and controls cells to ensure thorough re-suspension
- vii. Add 75µl of Test cells to first well containing diluted patient cells and ensure thorough mixing
- viii. Add 75µl of control cells to second well containing diluted patient cells and ensure thorough mixing
- ix. Incubate at room temperature {15-30°C} on a vibration free surface for a minimum of 45minutes {60 minutes may be necessary for optimum results with some plate readers}
- x. Read and interpret the setting pattern, Agglutination pattern are stable for at least 3 hours if undisturbed.

### **Semi-Quantitative Assay**

- i. Dilute sample {1/20} by adding 190µl of TPHA diluent and 10µl of the sample to a well.
- ii. Thoroughly mix sample and diluents
- iii. Dilute negative and positive controls just like the sample and treat them in a similar manner as below.
- iv. Leaving the first well empty, add 25µl of TPHA diluent to remaining 7 wells in an 8 well sequence.
- v. Add 25µl of the diluted sample from step 1 above to the 1st well in step 4.
- vi. Add 25µl of the diluted sample from step 1 above to the 2nd well in step 4 and mix thoroughly.
- vii. Perform serial dilutions from the 2nd well up to the 8th well; discard the excess 25µl from the 8th well.
- viii. Gently mix the Test cells to ensure thorough re-suspension.
- ix. Add 75µl of Test cells to all wells, ensure thorough mixing

#### **Note:**

Final sample titration after addition of cells in wells 1 to 8 is 1/80; 1/160; 1/320; 1/640; 1/1280; 1/2560; 1/5120; 1/10240 respectively.

Each sample should be tested for non-specific reactions by performing simultaneous a test with control cells {25µl of 1/20 diluted sample + 75µl control cell

- x. Incubate at room temperature {15-30°C} on a vibration free surface for minimum of 45 to 60minutes.
- xi. Read and interpret the settling pattern. Agglutination pattern are stable for at least 3 hours if undisturbed. The titre is the reciprocal of highest dilution giving agglutination.

#### **6.17.13      *Biological Reference Intervals***

Not applicable

#### **6.17.14      *Interpretation And Reporting Of Results***

Strong positive will show full cell pattern covering the bottom of the well on the Test cells and negative button on the control cells.

Weak positive will show cell pattern covers approximately 1/3 of the well button on the Test cells and negative button on the control cells

Indeterminate cell pattern shows a distinctly open centre on the Test cells and negative button on the control cells

Negative cells settled to a compact button, typically with a small clear centre on the Test cells and negative button on the control cells

Weak and strong agglutination should be reported as: TPHA – Positive and indicate the titre e.g., 1:1280.

#### **6.17.15      *Limitations Of The Procedure And Sources Of Error***

Humidity and temperature can adversely affect results.

Do not use beyond expiration date.

Do not perform the test in a room with strong airflow. i.e. ceiling fan or strong air-condition

Indeterminate and no agglutinin should be reported as: TPHA – Negative.

#### **6.17.16      *Performance Characteristics***

Refer to the method verification report of this procedure

#### **6.17.17      *Supporting Documents***

Sample collection manual

#### **6.17.18      *References***

Cypress Diagnostic TPHA package insert, 2010.

## **6.18 PROCEDURE FOR CHORELA RAPID DIAGNOSTIC TEST**

### **6.18.1 Purpose**

This procedure provides instructions for performing rapid Bioline Cholera Ag O1/ 0139 test

### **6.18.2 Scope**

The procedure is used for performing rapid Bioline Cholera Ag O1/ 0139 test in Microbiology section.

### **6.18.3 Responsibility**

Qualified, trained and competent health laboratory practitioners are responsible for performing this test

### **6.18.4 Principle**

Cholera antigen test contains a membrane strip which is precoated with mouse monoclonal anti- *vibrio cholera* O1 antibody on test line O1 region and with the device. These line in result window are not visible before applying any sample. The control line is used for procedural control. Control line should always appear if the test procedure is performed properly and the test reagents of control line are working.

A purple test line will be visible in the result window if *vibrio cholera* O1 and/or O139 antigens are present in the sample.

When a sample is added to the test, *vibrio cholera* O1 and O139 antigens in the sample react with colloidal gold-labelled *V. Cholerae* O1 and *V. Cholerae* O139 specific antibodies and form a complex of antigen-antibody colloidal gold conjugates. As this complex migrates along the length of the result window by capillary action, the complex is captured by the mouse monoclonal *V. cholerae* O1 antibody on test line O1 (O1) and mouse monoclonal *V. cholerae* O139 antibody in the test line O139 (O139) across the result window and generates a colored line. In the absence of *V. cholerae* O1 and O139 antigen in samples, a complex is not formed and no colored test line appears in the result window of test device.

### **6.18.5 Sample Requirement**

Human stool sample

### **6.18.6 Equipment**

Refrigerator

### **6.18.7 Materials**

Disposable gloves, Timer, Biohazard bag, Test device, Sample collection tube with extraction buffer, Sample collection swab for solid stool samples and Sample collection dropper for liquid stool samples

### **6.18.8 Storage and Stability**

- a) **For best result stool sample should be tested as soon as possible after collection.**
- b) Extracted stool sample is stable for 72 hours when store in 2-8°C
- c) Do not use stool sample in transport media or preservatives

### **6.18.9 Safety**

- a) Wear protective gloves while handling sample and wash hands after testing
- b) Do not mix or interchange different samples
- c) Decontaminate and dispose all sample test kits and potentially contaminated materials in a biohazard container as if they were infectious.
- d) Do not mix reagents of different lots or those of other products.

### **6.18.10 Calibration**

Not applicable

### **6.18.11 Quality Control**

- a) the cholera antigen rapid test has three test lines O1, O139 and control line. The control line is used for procedural control and shows that the diluent has been applied successfully and that the active ingredients of main components on the strip are functional.
- b) Use samples with known results (positive and negative) to test each test kit batch before use and ensure the results correlate with the respective control samples.

### **6.18.12 Procedural Steps**

#### **Sample Collection**

##### **In case of solid stool sample.**

- a) Loosen the filter cap of the sample collection tube.
- b) Collect the sufficient stool sample (about 50mg) from different 4-5 sites of stool samples using the sample collection swab.
- c) Immediately place the swab into the sample collection tube.
- d) Vigorously mix the solution by rotating the swab at least 10 times against the side of the sample collection tube.
- e) Release as much liquid as possible from the swab by squeezing the sides of the swab as the swab is withdrawn.
- f) Discard the swab and then assemble filter cap on the sample collection tube.

##### **In case of liquid stool sample.**

- a) Loosen the filter cap of the sample collection tube.
- b) Draw liquid samples up to the fill line (about 300ul) using disposable dropper.
- c) Immediately transfer liquid sample into the sample collection tube.
- d) Discard the dropper and then assemble filter cap on the sample collection tube.

### **6.18.13 Testing Procedure.**

- a) Bring the test device and sample to reach a temperature between 15-30°C for at least 30 minutes in case they were refrigerated.
- b) Remove the test device from the foil pouch and place it on a flat, dry surface.
- c) Shake the collection tube thoroughly to ensure proper mixing of the sample with extraction buffer.
- d) Loosen the nozzle cap of the sample collection tube.
- e) Hold the collection tube vertically and dispense 3 drops (70ul) into the sample well of test device.
- f) Wait a minimum of 15 minutes then read results. Do not read test results after 15 minutes; reading results after 15 minutes can yield false results.

#### **6.18.14 Biological Reference Intervals**

Not applicable

#### **6.18.15 Interpretation And Reporting Of Results**

A coloured control line will appear in the left section of the result window to show that the test is working properly.

Coloured lines will appear in the middle and right section of the result window. These lines are test line 0139 and test line 01 (0139, 01).

**Negative Result:** The presence of only control line (C) within the result window indicates a negative result.

**Positive Result:** The presence of two lines as control line (C) and test line 01 (O1) within the result window indicates a positive result for *V. cholerae* 01 antigen.

The presence of two lines as control line (C) and test line 0139 (0139) within the result window indicates a positive result for *V. cholerae* 0139 antigen.

The presence of three lines as control line (C) test line 01 (O1) and test line 0139 (0139) within the result window indicates a positive result for *V. cholerae* 01 and 0139 antigen.

**Caution:** The presence of any line, no matter how faint, the result is considered positive.

**Invalid Result:** If the control line (C) is not visible within the result window after performing the test, the result is considered invalid.

#### **6.18.16 Limitations Of The Procedure And Sources Of Error**

- a) A negative result does not exclude the possibility of *V. cholerae* 01 and/or 0139 infection in a patient. Failure to detect *V. cholerae* 01 and/or 0139 may be a result of factors such as collection of samples at an improper time in the disease when few bacteria are present and improper sampling or handling of the sample.
- b) A positive result does not preclude the presence of other enteric pathogens. While the relationship between cholera and gastroenteritis is well established, concurrent infection with other microbial pathogens is possible. Additional microbiological tests should be performed in parallel with Bioline Cholera Ag O1/ 0139 test kit in order to exclude other possible causes of the illness.



- c) Test results should be interpreted in conjunction with information available from epidemiological studies, clinical symptoms of the patient and other diagnostic procedures.

**6.18.17      *Performance Characteristics***

Refer to manufacture user manual

**6.18.18      *Supporting Documents***

Sample collection manual

**6.18.19      *References***

Refer to manufacture user manual

# CHAPTER 7: BACTERIOLOGY AND MYCOLOGY

---

## 7.1 POTASSIUM HYDROXIDE (KOH) WET MOUNT PREPARATION

### 7.1.1 Purpose

This procedure provides instructions for examination of wet preparations that is mainly used to examine samples and cultures for motile bacteria, C.S.F for capsulated yeast cells and for fungi.

### 7.1.2 Scope

This procedure applies to the microbiology section and health laboratory practitioners in the laboratory settings.

### 7.1.3 Responsibility

Competent Health Laboratory Practitioners are responsible for implementing this test procedure.

The Head of Microbiology/who assigned is responsible for ensuring the effective implementation and maintenance of this procedure.

### 7.1.4 Principle

A KOH preparation is used for Samples such as skin scrapings, nail, infected hairs, or for other Samples such as sputum to clear out background debris that may be confused with fungal elements. KOH dissolves proteinaceous tissues, including keratin, and renders them transparent. This enables fungi to be visualized more easily. The use of KOH is not necessary for Samples such as CSF where background debris is minimal.

### 7.1.5 Sample Requirements

KOH preparation is used ideally in suspected cases of dermatophytosis, i.e., fungal infection of skin, hair, or nails. Also used for sample such as sputum, pus, and urine sediment.

### 7.1.6 Equipment

Microscope

### 7.1.7 Materials

Potassium hydroxide 10 or 20%, Potassium hydroxide 10 g, Glycerol 10ml, Deionized water 80ml, (optional) helps prevent the KOH mount from drying. Dispense working solution in a dropper bottle. Microscope slides, 24 x 50 mm cover slips, sterile forceps, mounting needle

### 7.1.8 Storage and Stability

Potassium hydroxide, 10 or 20% solution is stable for one year at room temperature

### 7.1.9 Safety

Observe standard safety precautions when handling Samples. Refer to Safety Manual

Discard all used materials (e.g., sticks, pipettes, disposable forceps) in a bucket containing bleach.

#### **7.1.10 Calibration**

Not applicable

#### **7.1.11 Quality Control**

Fungal spores may contaminate the KOH solution, and may give false positive results. Solution must be examined for signs of contamination (e.g., turbidity) before each use.

#### **7.1.12 Procedure Steps**

- i. Place the material to be examined on a glass slide, add a drop of 10% KOH
- ii. Place a cover slip over the preparation.
- iii. Let stand for five to ten minutes.
- iv. If clearing is not complete, an additional ten minutes is necessary.

**Note:** *Keratinous (skin, nails) Samples should be left at room temperature for 20 to 30 minutes to allow digestion and “clearing” of the keratin, after clearing, press coverslip gently to make a thin mount.*

- v. Examine the slide microscopically on low power and confirm observations with high power. Observe for hyphae, conidia, budding yeasts, spherules or sclerotic bodies, etc. Consult photomicrographs in appropriate references when necessary, to identify fungal structure.

#### **7.1.13 Biological Reference Intervals**

Not applicable

#### **7.1.14 Interpretation and Reporting of Results**

##### **Interpretation**

Dermatophytes in skin or nail are seen as branching hyphae or arthrospores and often appear slightly greenish in color, with hyphae running across the colorless host cells. Most hyphae will be parallel-sided and around 2  $\mu\text{m}$  in width.

Yeasts are present as budding cells, pseudohyphae, or yeast mycelium.

In infections caused by dematiaceous fungi, the hyphae are often brown (dematiaceous septate hyphae).

Artifacts, such as fibers, may be distinguished from hyphae from the lack of septa, tapering ends, and size differences.

##### **Reporting of Results**

Report the type of fungal structure seen. Do not report quantity.

**Examples:** “Fungal elements seen (septate hyphae)”

“Fungal elements seen (yeast cells and pseudohyphae)”

Report negative results as: “No fungal elements seen”

Report as: “Fungal elements seen (*Malassezia* spp.)”

#### **7.1.15 Limitations of the Procedure and Sources of Errors**

- i. Cotton swabs should not be used in preparing these slides as the cotton strands may resemble hyphae.
- ii. The contrast between unstained fungal elements that may be present and the background mounting fluid can be accentuated by narrowing the iris diaphragm to reduce the amount of incident light; or use of phase-contrast microscopy that can greatly enhance visualization of organisms.
- iii. KOH preparations are presumptive and should not be substituted for culture and further identification.
- iv. KOH should not be stored in a glass bottle as it will leach minerals from the glass. The minerals will result in a cloudy, flocculant solution. This can be avoided by storing the KOH in plastic, polystyrene or other non-glass container.
- v. Gentle heating may speed the activity of the KOH, but it may be harmful to the sample if overdone.
- vi. KOH preparations are not permanent; the reagent will eventually destroy the fungi. The addition of small amount of glycerol to the preparation will preserve it for several days.
- vii. KOH combined with calcofluor white is a more sensitive method, but a fluorescent microscope with appropriate filter is required.
- viii. India ink, added to the KOH, stains fungal elements and helps them stand out against the background. Reagent is prepared as follows: Make a 10% KOH solution in Parker Super Quink Ink, permanent blue black (50 ml of ink + 5 g of KOH pellets). Centrifuge KOH-ink solution at 2,000 x g for ten minutes. Pour supernatant into plastic (not glass) sterile tube. Store at room temperature.

#### **7.1.16 Performance Characteristics**

Not applicable

#### **7.1.17 Supporting Documents**

Not applicable

#### **7.1.18 References**

- ✓ Lynne S. Garcia, Henry D. Isenberg. Clinical Microbiology Procedures Handbook. 3<sup>rd</sup> edition.
- ✓ American Society for Microbiology. Washington DC, USA. 2010.
- ✓ Guidelines on Standard Operating Procedures for Laboratory Diagnosis of HIV/AIDS Opportunistic Infections in Patients. WHO Regional Office for Southeast Asia. New Delhi. June 2001
- ✓ Bailey and Scott's Diagnostic Microbiology. 13<sup>th</sup> edition. Mosby, Inc. St. Louis, Missouri, USA. 2013.

## **7.2 PROCEDURE FOR ZIEHL NIELSEN (ZN) STAIN**

### **7.2.1 Purpose**

This procedure provides instructions for performing Ziehl-Nielsen stain of sputum or other body fluid samples.

### **7.2.2 Scope**

This procedure is to be used for detection of Acid Fast Bacilli in sputum or other body fluid samples in the Laboratory

### **7.2.3 Responsibility**

The section heads and technical staffs are responsible for implementing this procedure.

### **7.2.4 Principle**

This procedure is used to stain mycobacterium tuberculosis and mycobacterium leprae. These bacteria are also called acid fast bacilli. They stain with carbolfuchsin, which is a red dye. They retain the dye when treated with acid, which is because of the presence of mycolic acid in their cell wall.

### **7.2.5 Sample Requirements**

The Sputum and body fluids such as CSF, synovial, pericardial, synovial, ascitic, blood, pus, bone marrow, tissue biopsies or pleural fluid samples.

### **7.2.6 Equipment**

Centrifuge (when necessary), Bunsen burner/spirit lamp, Light Microscope and Biosafety cabinet

### **7.2.7 Materials**

ZN stains reagents: 1% Carbol Fuchsin stain, 20% Sulphuric acid and 0.125% Methylene blue. Acid Fast Bacilli Positive and negative Control slides for zn.

Personal protective gears, Gauze, Glass slides, Staining racks, Drying rack, Clean Glass slides, Applicator stick, Micropipette or Pasture pipettes, sputum container, timer

### **7.2.8 Storage and Stability**

Sputum samples should be processed within 3 days if stored at room temperature and if not possible store it at 2 to 8°C for 10 days.

### **7.2.9 Safety**

Decontaminate working surfaces as recommended by IPC Guidelines.

All personal protective equipment (PPE) must be worn when performing this procedure.

All samples must be regarded as potentially infectious.

Refer to National infection prevention and control Guidelines for health waste management and safety practice.

### **7.2.10 Calibration**

Centrifuge and safety cabinety should be calibrated as per schedule

### **7.2.11 Quality Control**

Perform IQuality control by Smearing and staining known Negative and positive sample /EQA before examining any patient sample every day.

Perform lot to lot for every new batch of reagent received

### **7.2.12 Procedure Steps**

- i. Place the fixed slides with smear upwards on a staining rack over a sink about 1 cm apart.
- ii. Flood the smear with filtered carbol fuchsin staining solution.
- iii. Prepare a torch by dipping its cotton wool end in burning spirit and light it. Use only a few drops on acid alcohol or 70% v/v ethanol or methanol.
- iv. Heat the slide keeping the torch a little below the slide and moving it continuously forth and back along the line until steam arises, repeat twice at intervals of 3-5 minutes. Do not overheat. Allow slides to stand for at least 30 minutes.
- v. Tilt the slide using forceps to drain off the staining solution.
- vi. Rinse the slide well with clean water from a beaker (or running tap water).
- vii. Pour the 20% Sulphuric acid or 3%Hcl over the smears, covering them completely. Allow to act for 3 minutes.
- viii. Tilt the slide with forceps to drain off the acid solution; then gently rinse the slide again with clean water.
- ix. Repeat covering by sulphuric acid or Hcl solution and rinsing once for smears that are still red.
- x. Flood smear with methylene blue solution for 1 minute.
- xi. Tilt the slide with forceps draining off the Methylene blue solution.
- xii. Wash with clean water.
- xiii. Using forceps take the slide from rack, drain off water and stand the slide on the edge to air dry on the drying rack.
- xiv. Examine the smear microscopically first with the 40x objective to see the distribution of material, then with the oil immersion objective to look for Acid Fast Bacilli . Open fully the condenser iris when using the oil immersion lens. After examining a positive smear, the oil immersion objective must be wiped clean.

**Note:** *The stained smear should show a light blue colour from methylene blue. If the smear is dark blue, it usually indicates that the smear is too thick.*

### **7.2.13 Biological Reference interval**

Not applicable

### **7.2.14 Interpretation and Reporting of Results**

Acid Fast Bacilli appears as Red, straight or slightly curved rods, occurring singly or in small.

If any definite red bacilli are seen, report the smear as Negative If no red bacilli are seen in at least 100 fields and 'Acid Fast Bacilli positive' if give an indication of the number of bacteria present as follows:

More than 10 AFB/HPF field	Report + + + OR +3
1 – 10 AFB/HPF field	Report + + OR +2
10 - 99 AFB/100 fields	Report + OR +1
-9 AFB/100 fields	Report the exact number/100
If no red bacilli are seen in at least 100 fields	Report as negative

### **7.2.15 Limitation of the Procedure and Sources of Error**

- i. Re use of containers or positive slides.
- ii. Contaminated stain prepared with water containing environmental mycobacteria.
- iii. Use of scratched slides.
- iv. Acid Fast Bacilli floated off one slide and became attached to another during staining procedure because of no distance between each slide.
- v. Poor quality of staining solutions.
- vi. Taking improper portion of sample for smear preparation.
- vii. Improper focal distance for examination.
- viii. Use of poorly prepared staining solution.
- ix. Overheating during fixing.
- x. Too long interval between staining and reading, especially when slides not kept in dark or poorly stained.

### **7.2.16 Performance Characteristics**

Not applicable

### **7.2.17 Supporting Document**

Patients Results Register - TB 05

Internal Quality Control review form

### **7.2.18 References**

- ✓ Clinical Microbiology Procedures Handbook. American Society for Microbiology. Washington D.C., USA, 2<sup>nd</sup> edition, 2007.
- ✓ Monica cheesbrough (2005). District Laboratory Practice in Tropical countries. Cambridge University Press, New York, USA, 2<sup>nd</sup> edition, 2005.
- ✓ WHO, (2003). Manual of basic techniques for a health laboratory. Geneva. 2<sup>nd</sup> edition, 2003.
- ✓ Manual of Clinical Microbiology. American Society for Microbiology (ASM), Washington D.C., USA. 9<sup>th</sup> edition, 2007.

## **7.3 PROCEDURE FOR AURAMINE O PHENOL STAINING**

### **7.3.1 Purpose**

The Auramine O staining technique applies to identification of Acid Fast Bacilli in patient sample using fluorescence Microscopy which increase the rate of detection compared to the light microscopy.

### **7.3.2 Scope**

This procedure is to be used for detection of Acid Fast Bacilli in sputum or other body fluid samples in the Laboratory by using Auramine O reagents.

### **7.3.3 Responsibility**

Competent Health Laboratory Practitioners are responsible for implementing this test procedure.

The Head Microbiology is responsible for ensuring the effective implementation and maintenance of this procedure

### **7.3.4 Principle**

The fluorochrome dye, Auramine-Rhodamine, forms a complex with mycolic acids contained in the acid fast cell wall of organisms which resist decolorization by acid-alcohol. The counterstain, Methylene blue 0.3%, renders tissue and its debris non fluorescent, thus reducing the possibility of artifacts. The cells visualized under ultraviolet light appear bright yellow or reddish orange.

### **7.3.5 Sample Requirements**

Mucoid, purulent or blood stained samples.

### **7.3.6 Equipment**

Biosafety cabinet, Fluorescent microscopes, Timer, Bunsen burner/ Spirit lamp

### **7.3.7 Materials**

Auramine –O phenol 0.1%, Hydrochloric acid in Alcohol 0.5%, Methylene blue 0.3%, Microscopic slides, Slide holding box, Gloves, Gauze/Cotton wool, Beaker, Forceps Applicator sticks/Disposable, Pencil, Dry rack, Slide racks, wide mouth sputum container for routine samples or Falcon tube 50ml for referral samples.

### **7.3.8 Storage and Stability**

Sputum samples should be processed within 3 days if stored at room temperature and if not possible store it at 2 to 8°C for 10 days.

### **7.3.9 Safety**

Decontaminate working surfaces as recommended by IPC Guidelines.

All personal protective equipment (PPE) must be worn when performing this procedure.

All samples must be regarded as potentially infections.

Refer to National infection prevention and control Guidelines for health waste management and safety practice.



### **7.3.10 Calibration**

Centrifuge and safety cabinet should be calibrated as per schedule

### **7.3.11 Quality Control**

Internal Quality Control should be done by smearing and staining known Negative and positive sample before examining any patient sample every day. Perform lot to lot for every new batch of reagent received/prepared.

### **7.3.12 Procedure**

#### **Film Preparation**

- i. Label the slides properly using a unique laboratory number
- ii. Place the labeled slides, the samples and the applicator stick /Pasteur pipette in the Biological safety cabinet
- iii. Match each slide with the corresponding sputum or sample container.
- iv. Proceed to smearing, taking the labeled slides and opening containers one by one, do the smearing from the center of the slide, outwards making small coil – like movements (A thin smear ,allow to air dry).
- v. Select a small portion of purulent or muco-purulent material with the applicator stick for a direct sputum smear and then transfer it to the slide, if a stick is used, break it in two pieces and used ragged ends for dissecting sputum and for smearing.
- vi. Spread the material carefully over the area equal to about 2×1 cm using repeated coil like movements, without touching the margins of the slides and should be in the middle.
- vii. Make the smear as even as possible by continuing this process until no thick parts remain. Remove excess material with the second stick and discard in the biohazard bag.
- viii. The thickness of the smear should be such that a newspaper can be read through the dried smear held about 10cm above it (Translucent).
- ix. Warm the slides on the slide warmer in the biological safety cabinet to dry and fix the smear for at least 30minutes.
- x. Re-fix the smears by passing a flame under the slides before staining.
- xi. If the slide warmer is not functioning, air dry the smear then fix them by passing a flame under the smear ,the smear should face upward ,do not over heat ,or else Acid Fast Bacilli staining will be poor.

#### **Fluorescent Microscopy Staining Procedure**

Place the slides on staining rack. IT IS A MUST to keep distance of at least 1cm between every slide. Otherwise there is a possibility that acid fast bacilli may cross contaminate the negative smears due to over flooding or splashes from positive smear to a negative smear

- i. Cover the smear completely with filtered 0.1% auramine solution **Do not heat**
- ii. Leave for 15 minutes
- iii. Wash the slides well with distilled water or running water

- iv. Pour the acid alcohol solution over the slides.
- v. Allow to act for 2- 3 minutes.
- vi. Gently rinse each slide with distilled or running water.
- vii. Repeat decolourization if macroscopically visible stains are still visible.
- viii. Flood smear with 0.5% methylene blue counter solution for 1 minute .Time is critical because counterstaining for longer time may quench the acid fast bacilli
- ix. Gently wash off counterstain with distilled or running water.
- x. Stand the slides on edge to drain and air dry on the slide rack away from direct sun light.

### Examination

- i. Keep stained smears in the dark (box or folder) till reading, and read as soon as possible (within 24hours) since fluorescence fades quickly out of the box.
- ii. Use 20 x objectives for scanning and 40x confirmation; scan the stained smear systematically from one side to another side
- iii. One length has to be scanned before reporting a Negative.
- iv. Acid-fast bacilli appear bright yellow against the dark background material.
- v. Store the slides in a slide box according to the study, following the laboratory Number as they will be needed for EQA.

**Note:** Acid fast bacilli appear bright yellow against dark background, report as possible for Acid Fast Bacilli if at least one acid-fast bacillus was seen in a well stained smear, even if you think they might be other mycobacterium other than tubercle bacilli. Tubercle bacilli are quite variable in shapes from very short fragments to elongated types. They may be uniformly stained or with one or many gaps, or even granular. They occur singly or in small groups (coded), and rarely in large clumps. The typical appearance of bacilli are usually rather long and slender, straight or slightly curved rods.

### 7.3.13 Biological Reference interval

Not applicable

### 7.3.14 Interpretation and Reporting of Results

If fluorescent Acid Fast Bacilli are seen, report the smear as Acid Fast Bacilli positive, and give an indication of the number of bacilli present in plus signs (+ to +++).

The results have to be reported on the working sheet and on patients result register (MTB Register 05 if available).

If no fluorescent rods are seen, report the smear as (NO AFB SEEN).

Report	Fluorescence (200magnification, one length 20x=field 200=HPF	Fluorescence (400magnification, one length 40x =field 200=HPF
Negative	Zero AFB/1 length	Zero AFB/1 length
Scanty	1-29 AFB/1 Length	1-19 AFB/1 Length
1+	30-299 AFB/1 Length	20-199 AFB/1 Length on average
2+	10-100 AFB/ 1field on average	5-50 AFB/1 field on average
3+	>100 AFB/ Field on average	>50 AFB/ Field on average

### **Critical values**

Presence of Acid Fast Bacilli

#### **7.3.15 Limitation of the Procedure and Sources of Error**

- i. Direct reagents to Sun light
- ii. Poor reagent quality
- iii. Using wrong reagent Concentration
- iv. Using unfiltered reagent
- v. Using expired reagent
- vi. Poor sample quality

#### **7.3.16 Performance characteristics**

Not applicable

#### **7.3.17 Supporting documents**

Patients Results Register - TB 05

Internal Quality Control

#### **7.3.18 References**

- ✓ International union against tubercle and lung diseases. The public health service national tuberculosis Reference laboratory and the national laboratory Network ,Paris 1998
- ✓ Smithwick R.W laboratory Manual for acid fast microscopy .US Department of Health ,Education and Welfare,CDC,1979
- ✓ Angra P, Becx-Bleumink M,Glipin C,et al,Ziehl Neelsen staining ,strong red on week blue, or weak red under strong blue Int J Tuberic Lung Dis 2007;11:1160-1

## 7.4 PROCEDURE FOR GRAMS STAINING

### 7.4.1 Purpose

This procedure provides instructions on the steps to be followed when performing Gram staining

### 7.4.2 Scope

This procedure will be used by all laboratory personnel perform gram staining to identify bacteria

### 7.4.3 Responsibility

It is the responsibility of the Head of Microbiology Section to ensure effectively implemented and maintained .

### 7.4.4 Principle

Gram stain based on the ability of bacteria cell wall. When the bacteria are stained with primary stain (crystal violet) and fixed by the mordant (Iodine), Gram Positive bacteria retain the primary stain when decolorized by ethanol (alcohol) because the cell walls of gram positive bacteria have THICK layer of protein-sugar components called peptidoglycan and low lipid contents. Upon decolourization Gram positive bacteria causes thick cell wall to dehydrate and shrink, which closes the pores in the cell wall and prevent the stain from existing the cell, therefore ethanol cannot remove crystal Violet-Iodine complex that is bound to the thick layer which peptidoglycan and appears BLUE. While Gram Negative bacteria are decolorized by ethanol. For the gram negative bacteria cell wall takes up the crystal violet-iodine complex but due to the thin layer of peptidoglycan and thick outer layer with form of lipids, crystal violate-iodine complex gets washed off, when they are exposed to decolorizer dissolves the lipids in the cell walls which allow the crystal violet-iodine complex to lead out of the cells then when again stained with counterstain (safranin) they pick up the safranin and appears red in color.

### 7.4.5 Sample Requirement

Fresh collected Pus, urine sediment, CSF, sputum, other body fluids

### 7.4.6 Equipment

Microscope, Timer, Bunsen burner/hot plate

### 7.4.7 Materials

Reagents	Consumables
<ul style="list-style-type: none"><li>• Crystal violet as primary stain</li><li>• Lugol's iodine as mordant</li><li>• 10% Acid/Acetone as decolourizer</li><li>• Neutral red/safranin as counter stain</li></ul>	<ul style="list-style-type: none"><li>• Gloves</li><li>• Gauze</li><li>• Waste bins</li><li>• Grass slides</li><li>• Applicator stick</li></ul>

### 7.4.8 Storage and Stability

- i. Samples are stable at 2-8°C for 7 days
- ii. store reagents as instructed by manufacturer

#### **7.4.9 Safety**

- i. Adhere to safety precautions as stated in the Facility Safety manual/ IPC guideline
- ii. All personal protective equipment (PPE) must be worn when performing this procedure.
- iii. All samples must be regarded as potentially infectious.

#### **7.4.10 Calibration**

Perform Equipment calibration as scheduled.

#### **7.4.11 Quality Control**

Quality control is done daily when receiving/preparing a new batch of reagents. A known sample ATCC for gram positive *Staphylococcus aureus* and for gram negative *Escherichia coli* bacteria respectively are used.

#### **7.4.12 Procedural Steps**

##### ***Smear preparation and staining***

- i. Slide with one end frosted should be used for making smears so that a lead pencil can be used to label the slide clearly.
- ii. Use a sterile applicator stick to add one drop of normal saline on the slide.
- iii. Use a sterile applicator stick to transfer one pure colony on the slide and make a smear
- iv. Allow smear to air dry on a flat safe place.
- v. Flood the fixed smear with crystal violet for 30 seconds
- vi. Decant crystal violet and rinse gently slide with running tap water
- vii. Flood the slide with Lugol's iodine for 30 seconds
- viii. Rinse off iodine gently with flowing tap water
- ix. Decolorize by letting the reagent flow over the smear while the slide is held at an angle or tilt slide.
- x. Adjust decolorisation time to thickness of smear
- xi. Remove excess decolorizer with gentle flow of tap water
- xii. Flood with neutral red for 30 seconds
- xiii. Remove excess neutral red with gentle flow of tap water
- xiv. Drain slide and air dry in an upright position

##### **Reading smears**

Place the slide on the microscope and ensure that the smear is facing upward

#### **7.4.13 Biological Reference Intervals**

Not Applicable

#### **7.4.14 Interpretation And Reporting Of Results**

##### **Interpretation of results**

- If Bacteria pick the color of the counter stain (Neutral red/dilute Carbofuschin/safranin) THEN report as Gram Negative (Cocci, Bacilli/Rod depending on morphological observed/identified cells)
- IF stained bacteria pick the color of the primary stain (crystal violet) THEN report as Gram Positive (Bacilli/Rods or cocci depending on observed identified cells)

##### **Reporting of results**

- Results should be reported as Gram Positive Rods or Cocci according to the morphology of the bacteria or
- Gram NEGATIVE Rods or Bacilli according to the shape of bacteria

#### **7.4.15 Limitations Of The Procedure And Source Of Error**

Avoid over staining,  
Avoid over decolourization  
Do not use expired reagent.

#### **7.4.16 Performance Characteristics**

Refer to method verification report of this procedure

#### **7.4.17 Supporting Document**

Sample collection manual

#### **7.4.18 References**

Districtlaboratory practice in tropical countries. Part 2: Author Monica Cherbourg 6th edition

## **7.5 PROCEDURE FOR INDIAN INK STAIN**

### **7.5.1 Purpose**

This procedure provides instructions for performing Indian ink stain to demonstrate cell capsules through microscopic examination eg *Cryptococcus neoformans* in human.

### **7.5.2 Scope**

This procedure is used in microbiology department to demonstrate cell capsules through microscopic examination.

### **7.5.3 Principle**

*Cryptococcus neoformans* affects immunocompromised hosts predominantly and is the most common cause of fungal meningitis. Preparations of cerebrospinal fluid (CSF) in India ink will allow the presumptive identification of encapsulated cryptococcal cells. This stain is also suitable to use on other body fluids and urine.

The cryptococcal polysaccharide capsule is present on nearly all *Cryptococcus* spp. and is resistant to coloration by India ink. The capsular material of cryptococci displaces the colloidal carbon particles of the ink so that the capsule appears as a clear halo around the microorganisms against a black background. This procedure is not a staining technique but a method that creates the illusion of dark-field microscopy.

### **7.5.4 Responsibility**

Qualified trained and competent laboratory staff can perform this test.

Head of section is responsible to ensure implementation and competence assessment for all staff.

### **7.5.5 Sample Requirements**

CSF, other body fluids, urine

### **7.5.6 Equipment**

Microscope, Centrifuge.

#### **Maintenance**

Maintenance of equipment should be performed as planned.

### **7.5.7 Materials**

India Ink, aqueous suspension. Nigrosin stain may also be used.

Microscope slides, 24 x 50 mm coverslips, sterile loops, sterile transfer pipettes, sterile disposable centrifuge tubes.

### **7.5.8 Storage and Stability**

Sample and in-house prepared IQuality control can be stored in a -20°C for one year.

### **7.5.9 Safety**

Treat all samples and slides as potential infectious.

Adhere to Safety manual and IPC guideline.

### **7.5.10 Calibration**

Calibration of equipment should be performed as planned

#### **7.5.11 Quality Control (Quality control)**

- Ensure that all media and supplies used have passed the required Quality control and are used within their expiry date.
- India ink controls should be run simultaneously with the sample being tested. Record results on Quality control form.
- Stain Control: Place a drop of India ink on a slide, cover with coverslip, and examine for signs of contamination. Do not use if extraneous material or organisms are present in the stain control slide.
- Positive Control: One drop of *Cryptococcus neoformans* suspension + one drop India ink.
- Negative Control: One drop of *Candida albicans* suspension + one drop India ink.
- Record results on Quality control form.

#### **7.5.12 Procedure Steps**

- i. Make the preparation in the center of a clean, grease-free glass slide.
- ii. Put one small drop of India ink on the center of the slide.
- iii. Put one drop of the sample close to the drop of the stain.
- iv. Mix the two drops well with a sterile loop or wooden applicator stick.
- v. Hold the coverslip vertically such that one edge just touches the fluid on the side. The fluid will spread on the edge by surface tension.
- vi. Keeping the edge in contact with the fluid surface, drop the coverslip gently on the fluid.
- vii. If there are air bubbles, the surface of the coverslip may be gently tapped by a needle point, to move the bubbles towards the edge, but this should be avoided as far as practicable.
- viii. Examine slide immediately under the bright field microscope.
- ix. Examine the entire coverslip under low power and high power magnification.
- x. Too much stain makes the background too dark. If the staining appears too dark, add a drop of water on one side of the coverslip and gently tap the coverslip. This dilutes the stain to some extent.
- xi. The edges of the coverslip should be especially examined. While placing the coverslip, the yeast cells tend to move towards the periphery along with the fluid. For this reason, the practice of draining the extra fluid from the sides should be avoided.

#### **7.5.13 Biological Reference Intervals**

Not applicable

#### **7.5.14 Interpretation and Reporting of Results**

##### **Interpretation**



- Encapsulated yeast cells are seen under low power as luminous dots in an otherwise dark background. Under high power (100x to 200x), the cells can be seen containing refractile nuclei, and surrounded by the unstained thickness of the capsule.
- The capsules of cryptococci are usually sharply outlined and the well-defined yeast cell wall is centrally located within the capsule.
- Capsules may be broad or narrow. The yeast cells may be round, oval, or elongate; buds may be absent, single, or, rarely, multiple. The buds may be detached from the mother cells but enclosed in a common capsule.
- Besides the classical budding-yeast form, various unusual forms can also be seen including elongated forms that look like pseudohyphae; this is mainly due to the very high multiplication rate of the organism in HIV/AIDS patients.
- In the very late stage in progressive AIDS, it may be difficult to differentiate the capsules of individual cells; the organism may remain enmeshed in a matting of the capsular material.
- False positive reactions may occur with air bubbles or monocytes. Air bubbles, under the high power, will be hollow and will not show the typical cell with characteristic nuclei. Monocytes have a crenated margin, and will not show the characteristic nuclei, and the luminous halo around the cell is not well demarcated

### Reporting of Results

- Preparations showing budding encapsulated yeast cells should be reported out as:
- "Positive – Encapsulated yeast cells seen."
- Preparations showing no encapsulated yeast cells or where questionable structures are seen should be reported out as:
- "Negative - No encapsulated yeast cells seen."
- India ink preparation is a presumptive test. Results obtained with a presumptive test must be consistent with other information regarding the yeast (e.g., colony and cell morphology) and the clinical sample from which the yeast was isolated.
- Characteristics of *C. neoformans*:
  - *Culture (SDA)*: Colonies are cream-colored smooth and mucoid.
  - *Microscopy*: Globose to ovoid budding yeast-like cells 3.0-7.0 x 3.3-7.9  $\mu\text{m}$ .
  - *Plate Culture on Cornmeal with Tween 80 Agar*: Budding yeast cells only. No pseudohyphae present.
  - *Bird Seed Agar*: Colonies turn dark brown in color as colonies selectively absorb a brown pigment from this media
  - *Germ Tube test*: Negative
  - *Hydrolysis of Urea*: Positive
  - *Growth on Cycloheximide medium*: Negative.
  - *Growth at 37°C*: Weakly Positive

### **7.5.15 Limitation of the Procedure and Sources of Errors**

- Positive India ink smears may be used as a presumptive diagnosis only. Definitive diagnosis must be accomplished by culture and/or antigenic detection (Cryptococcal latex antigen test).
- In case of HIV positive patients, > 90% of the cases may be positive by the India ink test, whereas in non-HIV cases, < 60% positivity is seen.
- Non-pathogenic Cryptococci and other yeast spp. may produce capsules.
- Micro- or non-capsulated varieties of the organism are also reported on rare occasion. In such cases, Gram stain of the sample is helpful in identification.
- If the protein content of the CSF is too high, India ink sometimes may form floccules, which make it difficult to demonstrate the capsule.
- In case of Nigrosin stain, the preparation dries up quite fast, which is a problem in hot climatic conditions, so quick examination is essential.

### **7.5.16 Performance Characteristics**

Refer to method verification of the test.

### **7.5.17 Supporting Documents**

Safety manual, Sample collection manual.

### **7.5.18 References**

- Isenberg, H.D. Clinical Microbiology Procedures Handbook. 3<sup>rd</sup> edition American Society for Microbiology. Washington DC, USA. 2010.
- Guidelines on Standard Operating Procedures for Laboratory Diagnosis of HIV/AIDS Opportunistic Infections in Patients. WHO Regional Office for Southeast Asia. New Delhi. June 2001
- Bailey and Scott's Diagnostic Microbiology. Mosby, Inc. St. Louis, Missouri, USA. 13<sup>th</sup> ed. 2013

## **7.6 PREPARATION OF CULTURE MEDIA**

### **7.6.1 Purpose**

This procedure provides instructions for preparing media

### **7.6.2 Scope**

This procedure is to be used in preparation of different media in Microbiology section

### **7.6.3 Responsibility**

Qualified and competent Laboratory practitioners are responsible for doing this test procedure. The section heads of microbiology are responsible for ensuring the effective implementation for this procedure.

### **7.6.4 Principle**

The principle of media preparation in microbiology is to provide a nutrient-rich environment for the growth of microorganisms. This involves combining the necessary ingredients in the correct proportions and sterilizing the medium to remove any contaminating organisms.

### **7.6.5 Sample Requirements**

Not Applicable

### **7.6.6 Equipment**

- Electronic balances, Autoclave

### **7.6.7 Materials**

#### **Material**

- Gloves, Autoclavable tape, Petri dishes

#### **Reagents**

- Desoxycholate Citrate Agar (DCA),
- MacConkey Agar, Selenite F broth,
- Sorbitol MacConkey (SMAC) *E. coli* O157: H7
- Blood agar Plate (BAP)
- Thiosulphate Citrate Bile Salt Sucrose Agar (TCBS),
- Xylose Lysine Desoxycholate Agar (XLD),
- Chocolate agar, Ethyle methylene blue agar

### **7.6.8 Storage and Stability**

- **Reagents:** Store according to manufacturer's specifications.
- **Kits:** Refer to manufacturer's specifications
- Media should be refrigerated as per manufacturer instructions

### **7.6.9 Safety**

All personal protective equipment (PPE) must be worn when performing this procedure.

All samples must be regarded as potentially infections.

Refer to National infection prevention and control Guidelines for healthcare services in Tanzania, February 2007.

### 7.6.10 Calibration

Not Applicable

### 7.6.11 Quality Control

#### For BA, MCA,

Test prepared media for sterility, ability to support growth, and ability to produce appropriate biochemical reactions. Record results on Quality Control Form.

If Quality control results are acceptable, label all media bags with Quality control labels.

Do not use media with unacceptable Quality control results. Document Quality control failures and corrective action taken. Inform tech-in-charge of all Quality control failures.

#### For KIA/TSI

Incubate 10% of the TSI/KIA agar tubes in the incubator at 35°C overnight to check for sterility. Store the prepared TSI/KIA tubes in the refrigerator.

For quality control the following organisms should be inoculated and checked for confirmation of biochemical reactions:

- a) *Escherichia coli* should give an acid slant and butt, with the production of gas but no H<sub>2</sub>S.
- b) *Shigella flexneri* should give an alkaline slant, acid butt, without production of gas or H<sub>2</sub>S.
- c) *Proteus spp* should cause blackening of the media indicating production of H<sub>2</sub>S.

#### For XLD

- Known *Salmonella typhimurium* and *Shigella spp* are inoculated in the media and should show the required reactions. *E. coli* is inoculated to show the colour changes.

### 7.6.12 Procedural Steps

#### Preparation of Media

##### 7.6.12.1 Sheep Blood Agar (BA)

- i. Weigh the blood agar base according to the instructions given on the label of the media powder. Suspend the powder in distilled or deionized water. If necessary, heat with frequent agitation and boil for 1 minute to completely dissolve the powder.
- II. Autoclave at 121°C for 15 minutes. Cool the medium to 50°C then add sterile defibrinated sheep blood. Mix well gently.
- III. Aseptically pour into sterile petri dishes. Allow media to cool at room temperature to remove excess moisture. **Do not leave lids ajar because this medium is easily contaminated.** Note: Media dispensing is best done inside the BSC to minimize contamination.
- iv. The prepared sheep blood agar plate should appear a bright red colour. If the plates appear dark red, the blood has been added when the agar was

too hot; if this happens, the medium should be discarded and a new batch prepared.

- v. Label plates with media name and preparation date.
- vi. Wrap plates in plastic bags, 10 plates per bag. Leave appropriate number of plates outside for quality control (Quality control). Label media bags with media name, preparation date, expiry date, and storage temperature.
- VII. Record media preparation on appropriate form.
- viii. Perform media Quality control.

### **Storage**

Store wrapped plates at 2° to 8°C for up to 8 weeks.

Prior to inoculation with patient samples, prepared media that have been refrigerated should be removed from refrigeration and equilibrated to room temperature. This is to allow water of condensation to evaporate or dissipate and to avoid temperature shock to the inoculum.

#### **7.6.12.2 Chocolate Agar**

- i. Weigh the blood agar base according to the instructions given on the label of the media powder. Suspend the powder in distilled or deionized water. If necessary, heat with frequent agitation and boil for 1 minute to completely dissolve the powder.
- ii. Autoclave, and cool to 50°C in a water bath.
- iii. Add 5% sterile defibrinated sheep blood (5ml blood per 100 ml agar). Mix well gently then place in a hot water bath at no more than 80°C for 15 minutes or until a chocolate colour is achieved. Cool media to 50°C.
- iv. Haemoglobin solution may be used if sheep blood is not available: Prepare a solution of 2% haemoglobin (5g in 250 ml distilled water). Mix the haemoglobin in 5-6 ml of distilled water to form a smooth paste. Continue mixing as the rest of the water is added. Autoclave, and cool to 50°C. Add the sterile haemoglobin solution to 250 ml agar base and continue to hold at 50°C.
- v. Aseptically pour into sterile petri dishes. Allow to cool at room temperature to remove excess moisture. **Do not leave lids ajar because this medium is easily contaminated.** Note: Media dispensing is best done inside the BSC to minimize contamination.
- vi. Label plates with media name and preparation date.
- vii. Wrap plates in plastic bags, 10 plates per bag. Leave appropriate number of plates outside for quality control (Quality control). Label media bags with media name, preparation date, expiry date, and storage temperature.
- viii. Record media preparation on appropriate form.
- ix. Perform media Quality Control.

### **Storage**

- Store wrapped plates at 2° to 8°C for up to 8 weeks.

- Prior to inoculation with patient samples, prepared media that have been refrigerated should be removed from refrigeration and equilibrated to room temperature. This is to allow water of condensation to evaporate or dissipate and to avoid temperature shock to the inoculum

#### **7.6.12.3 MacConkey Agar (MCA)**

- i. Weigh the MAC agar according to the instructions given on the label of the dehydrated powder. Suspend the powder in distilled or deionized water. If required, heat with frequent agitation and boil for 1 minute to completely dissolve the powder.
- ii. Autoclave and cool the medium to 50°C. Aseptically pour into sterile petri dishes. Media dispensing is best done inside the BSC to minimize contamination. Allow to cool at room temperature to remove excess moisture.
- iii. Label plates with media name and preparation date.
- iv. Wrap plates in plastic bags, 10 plates per bag. Leave appropriate number of plates outside for quality control (Quality control). Label media bags with media name, preparation date, expiry date, and storage temperature.
- v. Record media preparation on appropriate form.
- vi. Perform media Quality control

#### **Storage**

Store wrapped plates at 20 to 80°C for up to 8 weeks. Prior to inoculation with patient samples, prepared media that have been refrigerated should be removed from refrigeration and equilibrated to room temperature.

This is to allow water of condensation to evaporate or dissipate and to avoid temperature shock to the inoculum.

#### **7.6.12.4 Cysteine Lactose Electrolyte Deficient (CLED)**

- i. Weigh the CLED agar according to the instructions given on the manufacturer's label of the dehydrated powder. Suspend the powder in distilled or deionized water. If required, heat with frequent agitation and boil for one minute to completely dissolve the powder.
- ii. Autoclave and cool the medium to 50°C. Aseptically pour into sterile petri dishes. Allow to cool at room temperature to remove excess moisture.
- iii. Label plates with media name and preparation date.
- iv. Wrap plates in plastic bags, ten plates per bag. Leave appropriate number of plates outside for quality control (Quality control). Label media bags with media name, preparation date, expiry date, and storage temperature.
- v. Record media preparation on appropriate form.
- vi. Perform media Quality control

#### **Storage**

Wrapped plates at 2° to 8°C for up to 8 weeks.

Prior to inoculation with patient samples, prepared media that have been refrigerated should be removed from refrigeration and equilibrated to room temperature. This is to allow water of condensation to evaporate or dissipate and to avoid temperature shock to the inoculum.

#### **7.6.12.5 Lysine Iron Agar (LIA)**

- i. Weigh the lysine iron agar according to the instructions given on the label of the dehydrated powder. Suspend the powder in distilled or deionized water. If required, heat with frequent agitation and boil for 1 minute to completely dissolve the powder.
- ii. Dispense into tubes and autoclave with screw caps loosened.
- iii. Cool tubes in a slanted position to form slants with deep butts.
- iv. Tighten tube caps. Label tubes with media name and preparation date.
- v. Place tubes in a carton box. Label media box with media name, preparation date, expiry date, and storage temperature.
- vi. Record media preparation on appropriate form.
- vii. Perform media quality control (Quality control).

#### **Storage**

Stored at 4°C for up to 6 months. Make sure caps are tightly closed to prevent evaporation.

#### **7.6.12.6 UREA**

- i. Weigh the urea agar base according to instructions given on the label of the dehydrated powder. Suspend the powder in distilled or deionized water. If necessary, heat with frequent agitation and boil for 1 minute to completely dissolve the powder.
- ii. Autoclave media then cool to 50°C in a water bath. Add appropriate amount of sterile 40% urea solution.
- iii. Dispense into sterile screw-cap tubes then allow to cool. For Christensen's agar, allow to cool in a slanted position for use as slants.
- iv. Tighten tube caps. Label tubes with media name and preparation date.
- v. Place tubes in a carton box. Label media box with media name, preparation date, expiry date, and storage temperature.
- vi. Record media preparation on appropriate form.
- vii. Perform media quality control (Quality control).

#### **Storage**

Store at 4°C for up to 6 months. Make sure caps are tightly closed to prevent evaporation.

#### **7.6.12.7 Muller Hinton Media**

- i. Weigh required amount of culture media powder (as per manufacture's instruction).
- ii. Add required volume of distilled water.

- iii. Mix by swirling to dissolve the powder and then boil on the hot plate to complete dissolve the contents.
- iv. Autoclave the medium at 121°C for 15 minutes.
- v. Allow the media to cool according to manufacturer's instruction.
- vi. Dispense the media at correct volume into Petri dishes.
- vii. Let the media solidify then store the media in refrigerator for further use.

**To Prepare Mueller Hinton Agar with Sheep Blood (MHB):**

- i. Cool medium to 50°C and aseptically add 5% sterile defibrinated sheep blood. Mix well.
- ii. Check the pH of each batch of MHA and MHB when the medium is prepared. The agar medium should have a pH of  $7.3 \pm 0.1$  at room temperature and must therefore be checked after gelling. Check the pH by one of the following means:
  - iii. Macerate enough agar to submerge the tip of a pH electrode;
  - iv. Allow a small amount of agar to solidify around the tip of a pH electrode in a beaker or cup;
  - v. Use a surface electrode.
- vi. If the pH is outside the range, the pH of the medium should not be adjusted by the addition of acid or base, i.e., the batch of the Mueller Hinton plates should be discarded and a new batch of plates prepared. If the pH for every batch is too high or low, the entire lot of dehydrated medium may have to be returned to the manufacturer as unsatisfactory.
- vii. Allow the medium to cool further to room temperature to remove excess moisture. Do not leave lids ajar because this medium is easily contaminated.
- viii. Label plates with media name and preparation date.
- ix. Wrap plates in plastic bags, 10 plates per bag. Leave appropriate number of plates outside for quality control (Quality control).
- x. Label media bags with media name, preparation date, expiry date, and storage temperature.
- xi. Record media preparation on appropriate form.
- XII. Perform media Quality control.

**Storage**

Store wrapped plates at 2° to 8°C for up to 8 weeks.

Prior to inoculation with patient samples, prepared media that have been refrigerated should be removed from refrigeration and equilibrated to room temperature. This is to allow water of condensation to evaporate or dissipate and to avoid temperature shock to the inoculum.

Just before use, if excess moisture is on the surface, MHA plates can be placed in the incubator (35° to 37°C) until the moisture evaporates (usually 10–30 minutes). **Do not leave lids ajar because the medium is easily contaminated.**

**7.6.12.8 Sabourad Dextrose Agar -SDA**



- i. Materials needed:
- ii. Peptic digest of animal tissue.....5g
- iii. Pancreatic digest of casein.....5g
- iv. Dextrose.....40g
- v. Agar.....15g
- vi. Clean glassware carefully with detergent & rinse well with distilled water.
- vii. Prepare according to manufacturer's instructions. Suspend 65gm of the powder in 1000mls of distilled water. If more or less than 1000mls of the media is required to be prepared, then use this as a formula and calculate the required amount.
- viii. Mix thoroughly, heat with frequent agitation and boil for 1 minute to completely dissolve the powder. Sterilize the mixture by autoclaving at 121°C for 15 minutes.
- ix. Allow the medium to cool to about 50°C in a water bath.
- x. Dispense in sterile Petri dishes to a uniform depth of 3-4mm.
- xi. Let the medium solidify at a level surface.
- xii. Label with Lot number, date of preparation (can be the lot number) & media name (abbreviations of the media can be used).
- xiii. Store media in the dark at 2-8°C (avoid freezing).

#### **7.6.12.9 Thayer-Martin Agar**

##### **Preparation**

- i. Weigh 7.2g Thayer-Martin agar powder and put in the flask.
- ii. Add 100mls of distilled water.
- iii. Leave the powder to dissolve for about 5 minutes.
- iv. Mix the mixture thoroughly.
- v. Autoclave the medium at 121°C for 15 minutes.
- vi. Allow the media to cool to 60°C.
- vii. Aseptically add 100ml sterile hemoglobin solution 2% and 2mls supplement B or VX then mix well.
- viii. Dispense the media into sterile plastic Petri dishes to a volume of 20mls approximate. Weight for the media to solidify.
- ix. Label with the permanent marker on the plate lid TM, your names initials and the batch number.
- x. Perform sterility check by placing one plate in the incubator and the other on room temperature overnight.
- xi. Place the plates in plastic bags labeling outside the bag with the date prepared and the name to the media that is TM.

#### **7.6.12.10 Thiosulphate Citrate Bile Salt –TCBS Media**

##### **Preparation**

- i. Weigh 89g dehydrated Thiosulphate citrate bile salt powder.
- ii. Add 1000mls of distilled water.
- iii. Leave the powder to dissolve for about 5 minutes.

- iv. Mix the mixture thoroughly.
- v. Heat with frequent agitation and boil for one minute. **Do Not Autoclave.**
- vi. Allow the media to cool in water bath at 60°C.
- vii. Swirl and dispense aseptically in sterile Petri dishes, leaving lids slightly open to allow agar to solidify.
- viii. Once the agar hardens close lids and leave covered for 1 hour on the desk.
- ix. Perform sterility check by placing one of the plates overnight at 35°C.
- x. Place other plates in plastic bags, labeling outer the bag with the date prepared and the name of the agar.
- xi. Assign batch number to the media once the zone sizes are within the range.

### ***Soya Culture Broth***

- i. Weigh the Soya Culture Broth according to the instructions given on the manufacturer's label of the dehydrated powder. Suspend the powder in purified water.

**NB:** Dissolve 30 g of the medium in one liter of purified water.

### **Quality Control Specifications**

**Dehydrated Appearance:** Powder is homogeneous, free flowing, and light beige.

**Prepared Appearance:** Prepared medium is brilliant to clear, yellow to amber, with none to light precipitate.

- ii. Mix thoroughly. Dispense into tubes and autoclave at 121°C for 15 minutes with screw caps loosened.
- iii. Tighten tube caps. Label tubes with media name and preparation date.
- iv. Place tubes in a box. Label media box with media name, preparation date, expiry date, and storage temperature.
- v. Record media preparation on appropriate form.
- vi. Perform media Quality control

### **Storage**

- Sealed bottle containing the dehydrated medium at 2 - 30°C.
- Once opened and recapped, place container in a low humidity environment at the same storage temperature. Protect from moisture and light by keeping container tightly closed.

### **7.6.12.11 XLD**

- i. Weigh required amount of culture media powder (as per manufacture's instruction).
- ii. Add required volume of distilled water (as per manufacture's instruction).
- iii. Mix the contents thoroughly to dissolve the contents.
- iv. Heat with agitation until the medium boils to completely dissolve the medium.
- v. Cool the prepared media to 50°C and dispense into the plates. The volume should approximately be 20mls per each plate.

- vi. Wait for the media to solidify. Label on the plate XLD, your name initials and batch number.
- vii. Test for the sterility by incubating one plate at room temperature and the other in incubator. Test for the quality of the media.
- viii. Store the media in the Refrigerator in Plastic bags if available and they are ready for use.

#### **7.6.12.12 Kliger Iron Agar (KIA)**

- i. Prepare according to the manufacturer's instructions:
- ii. Suspend 65g of the powder in 1 l of purified water (Weigh 16.25g of the powder and dissolve into 250mls of purified water to prepare 250mls of the medium).
- iii. Mix thoroughly, heat with frequent agitation and boil for 1 minute to completely dissolve the powder.
- iv. Dispense a quantity of hydrated medium in appropriate tubes with a sufficient volume to give a deep butt and a long slant. (E.g. dispense 6.5ml of the medium into the screw cap tubes.
- v. Leave screw caps loose and autoclave the medium at 121°C for 15 minutes.
- vi. After autoclaving, allow the slants to solidify in a manner such that the medium in the butt of the tube is about 3.5 cm deep and the slant is about 2.5cm long.
- vii. Tighten the screw cap tops of the tubes and store at 4°C for up to 6 months.

#### **7.6.12.13 Alkaline Peptone Water (APW)**

- i. Weigh the APW according to the instructions given on the manufacturer's label of the dehydrated powder. Suspend the powder in distilled or deionized water. If necessary, heat with frequent agitation and boil for one minute to completely dissolve the powder.
- ii. Dispense into tubes and autoclave with screw caps loosened.
- iii. Allow to cool.
- iv. Tighten tube caps. Label tubes with media name and preparation date.
- v. Place tubes in a box. Label media box with media name, preparation date, expiry date, and storage temperature.
- VI. Record media preparation on appropriate form.
- vii. Perform media quality control (Quality control).

#### **Storage**

Store at 4°C for up to six months making sure caps are tightly closed to prevent a drop in pH or evaporation

#### **7.6.12.14 Bile Esculin Agar and Quality Control**

- i. Weigh the BE agar according to the instructions given on the manufacturer's label of the dehydrated powder. Suspend the powder

in distilled or deionized water. If necessary, heat with frequent agitation and boil for one minute to completely dissolve the powder.

- ii. Dispense into tubes and autoclave with screw-caps loosened.
- iii. Allow to cool in a slanted position for use as slants.
- iv. Tighten caps. Label tubes with media name and preparation date.
- v. Place tubes in a box. Label media box with media name, preparation date, expiry date, and storage temperature.
- vi. Record media preparation on appropriate form.
- vii. Perform media quality control (Quality control).

### **Storage**

Store at 4°C for up to six months. Make sure caps are tightly closed to prevent evaporation

### **Motility Indole Ornithine Media -MIO**

#### **Quality control and Sterility control**

- Incubate one tube of MIO in the incubator at 35°C over night and one tube at room temperature to check for sterility.
- For quality control the following organisms should be inoculated and check for biochemical reactions;

Organism	Motility	Indole	Ornithine
<i>E.coli</i>	+	+	+
<i>Klebsiella</i> spp	-	-/+	-

#### **Procedure**

- i. Clean glassware carefully with detergent & rinse well with distilled water.
- ii. Prepare according to manufacturer's instructions. Suspend 31gm of the powder in 1000mls of distilled water. If less than 1000mls is needed use this as a formula to calculate the amount of the powder to be added.
- iii. Mix thoroughly, heat with frequent agitation and boil for 1minutes to completely dissolve the powder. Sterilize the mixture by autoclaving at 121°C for 15 minutes.
- iv. Allow the medium to cool to about 50°C.
- v. Dispense medium into sterile screw cap heat resistant tube to a uniform depth.
- vi. Label with lot number, date of preparation (can be the lot number) & media name (abbreviations of the media can be used).
- vii. Store media at 2-8°C (avoid freezing).

#### **7.6.12.15 Sulphide Indole Motility (SIM) Medium**

- i. Weigh the SIM agar according to the instructions given on the label of the dehydrated media. Suspend the powder in distilled or deionized water. If necessary, heat with frequent agitation and boil for 1 minute to completely dissolve the powder.
- ii. Dispense into tubes and autoclave with screw caps loosened.

- iii. Allow the medium to solidify upright, forming a deep butt with no slant. When the medium is solidified and cooled, leave caps loose until the surface of the medium has dried.
- IV. Tighten caps. Label tubes with media name and preparation date.
- v. Place tubes in a carton box. Label media box with media name, preparation date, expiry date, and storage temperature.
- VI. Record media preparation on appropriate form.
- ii. Perform media quality control (Quality control).

### **Storage**

Store at 4°C for up to 6 months making sure caps are tightly closed to prevent evaporation.

### **7.6.13 Biological Reference Intervals**

Not Applicable

### **7.6.14 Interpretation and Reporting of the Results**

Not Applicable

### **7.6.15 Limitation of the Procedure and Sources of Errors**

Each media has its own procedure care on understanding of procedure is crucial

### **7.6.16 Performance Characteristics**

Refer to method verification reports

### **7.6.17 Supporting Documents**

Result Management procedure, Safety manual, Sample collection manual

### **7.6.18 References**

- Manual of Clinical Microbiology. American Society for Microbiology (ASM), Washington D.C., USA. 9<sup>th</sup> edition, 2007.
- Manual for the Laboratory Identification and Antimicrobial Susceptibility Testing of Bacterial Pathogens of Public Health Importance in the Developing World. U.S. Centres for Disease Control and Prevention (CDC), Atlanta, Georgia, U.S.A, and World Health Organization (WHO) Geneva Switzerland. 2003

## 7.7 URINE CULTURE

### 7.7.1 Purpose

This procedure provides instructions for processing urine sample for culture and sensitivity

### 7.7.2 Scope

The procedure is used in Bacteriology section when investigating for urinary tract infections (UTI)

### 7.7.3 Responsibility

Qualified and competent Medical Laboratory Practitioners are responsible for implementing this test procedure

### 7.7.4 Principle

The bladder and urinary tract are normally sterile. The urethra contains a few commensals and also the perineum which can contaminate the urine when it is being collected.

In female patients, the urine may become contaminated with organisms from the vagina. Vaginal contamination is often indicated by the presence of epithelial cell and a mixed bacterial flora.

Most urine samples will contain fewer than  $10^4$  contaminating organisms per ml provided the urine has been collected with care to minimize contamination and the sample is examined within 2 hours after collection before the commensals multiply significantly so that bacterial count will be unreliable.

### 7.7.5 Sample Requirements

Early morning mid-stream urine collected in a wide mouthed sterile container is the best sample. However mid-stream urines collected at any time can also be processed.

### 7.7.6 Equipment

35-37°C Incubator, Microscope, Centrifuge, Hot air oven, 2-8°C Fridge

### 7.7.7 Materials

Reagent	Consumables
Media: CLED or MacConkey, Blood Agar and Mueller Hinton	Sterile disposable Petri dishes
Urine multistick	Glass slides and over slips
Biochemical reagents	Standard wire loop (e.g. 1 $\mu$ l [0.001ml])
Centrifuge tubes	Spirit lamp/Cooking gas
Urine antibiotic disks	Match box
	Gloves

•

**Note: Cysteine lactose electrolyte-deficient (CLED) agar is used because it allows the growth of both Gram negative and Gram pos pathogens. The indicator in CLED is bromothymol blue and**

*therefore lactose fermenting colonies appear yellow. The medium is electrolyte deficient to prevent swarming of proteus*

### **7.7.8 Storage and Stability**

Process all urine Samples within four hours of collection. If not, refrigerate at 4 °C for no longer than 24 hours.

### **7.7.9 Safety**

- a. Decontaminate working surfaces as recommended by IPC Guidelines
- b. Adhere to safety precautions as stated in the Safety manual
- c. All personal protective equipment (PPE) must be worn when performing this procedure.
- d. All samples must be regarded as potentially infections.
- e. All spills should be wiped thoroughly using 1% sodium hypochlorite solution.

### **7.7.10 Calibration**

Not Applicable

### **7.7.11 Quality Control**

Quality control of media and reagents is done as per manufacturer instructions.

### **7.7.12 Procedural Steps**

#### **Day 1**

#### **Macroscopic Examination**

Examine urine sample macroscopically and report the colour, turbidity and odour

#### **Culture**

- Inoculate a well-mixed sample of urine onto half plate of blood agar and fully MacConkey agar or CLED using a sterile standardized loop.
- Holding the loop at 45° angle to the agar surface inoculate and streak the sample on the agar.
- Incubate the plates aerobically at 37°C for 18 – 24 hours.

#### **Screening method**

- A strip test which is simple and effective is to be done test for leukocyte esterase /nitrate reduction.
- The strip is dipped into the urine sample as instructed in package insert. any pink color is a positive reaction indicates the presence of leukocyte esterase and /or bacteria in excess of 10<sup>5</sup>per ml.
- Urine samples that are positive in the screening test should be cultures as soon as possible to prevent possible overgrowth by non-significant bacteria.
- If the strip does not develop the pink color it is interpreted as the negative screening test, culture must be done because the strip may not be sensitive enough to detect bacteria count of less than 10<sup>5</sup>per ml of urine

#### **Day 2. Reading plates**

- Examine the plates for pure growth and perform a colony count. Each colony represents 1000 bacterial cells/ml if 1µl (0.001 ml) loop is used.
- Perform gram stain and proceed to perform identification tests for the suspected organism (refer to Identification flow Chart/Biochemical tests for microorganisms)
- Perform the susceptibility tests using the recommended antimicrobial agents following Procedure for antibiotic susceptibility testing, in doubtful bacteriuria, isolates should be identified and susceptibility tests carried out.

### **Day 3. Reading Biochemical tests**

- Read the biochemical tests and identify the organism. (Identification flow Chart/Biochemical tests for microorganisms) and report the identified organism(s).
- Record the identification biochemical tests on Microbiology culture worksheet
- Read the susceptibility plates as recommended and report.

### **Calculations**

If 1µl (0.001 ml) loop is used, each colony represents 1000 bacterial cells. Therefore, if a plate has about 100 colonies, that represents 100 000 ( $10^5$ ) bacterial cells.

### **7.7.13 Biological Reference Intervals**

Not applicable

### **7.7.14 Interpretation and Reporting of Results**

#### **Report appearance as:**

Colour: Clear Yellow or brown

Turbidity: Cloudy

#### **Report Culture as:**

**Colonial morphology**, Colony count: 100,000 CFU/ml

Report cultures without growth as 'No bacteria growth'

**Note:** No need of indicating colony counts  $\geq 10^5$  CFU/ml.

Report mixed growth report as "Mixed growth" and request for a repeat sample that must be collected aseptically.

#### **Results interpretation**

- If significant growths appear  $10^5$ CFU/ML then do gram stain and identification tests accordingly.
- If non-significant growth i.e., less than  $10^4$ CFU/ML then reports as non-significant growth.
- If mixed growth then repeat culture on freshly submitted urine sample.
- If no bacteria growths report as no bacteria growth.
- Any growth from catheter or SPA, and mixed growth from repeat mixed cultures is significant.
- Colony count of  $\geq 100\ 000$  CFU/ml is considered as significant bacteriuria.
- Colony count of  $\geq 10\ 000$  CFU/ml but less than  $100\ 000$  CFU/ml is considered as doubtful bacteriuria.
- Colony count of  $< 10\ 000$  CFU/ml is considered as insignificant bacteriuria.
- The finding of any parasites, yeast cells, cellular casts and crystals is significant.



- Urine appearance of milky white may be due to Chyle and the possible cause would be Bancroftian Filariasis

#### **Common UTI pathogens**

**Gram pos:** *Staph. Saprophytic us*, *Staph. Aureus*, Haemolytic *Streptococci*, *Enterococci*.

**Gram Neg:** *Escherichia coli*, *Proteus spp*, *Pseudomonas aeruginosa*, *Klebsiella spp*, *N. gonorrhoea*

#### **7.7.15 Limitations of the Procedure and Sources of Errors**

- Delay in transportation and culture without proper storage [refrigeration at 2-8°C] may give false high bacteriuria (high colony count).
- Contaminants in urine sample multiply to significant numbers at room temperature.
- In non-refrigerated delayed samples, pus cells will lyse resulting in false low bacteriuria (low colony count).
- Bacteria in urine refrigeration for more than 24 hrs may die off giving false high bacteriuria or may die off giving a low bacteriuria. Morphology or integrity of cells present in urine may get affected and may lead to false cell counts. Fastidious organisms may not be isolated by this technique

#### **7.7.16 Performance Characteristics**

Not Applicable

#### **7.7.17 Supporting Documents**

- Laboratory quality policy manual
- Laboratory safety policy manual
- Laboratory sample collection manual

#### **7.7.18 References**

- Basic Laboratory Procedure in clinical bacteriology 2nd Edition.
- Cheesbrough, M (1987). Medical Laboratory Manual for Tropical Countries (Vol. II). Butterworth-Heinemann, London.

## 7.8 STOOL CULTURE

### 7.8.1 Purpose

This procedure provides instructions for processing stool and rectal swabs for culture and sensitivity

### 7.8.2 Scope

The procedure is used in the laboratory for the diagnosis of diarrhoea.

### 7.8.3 Responsibility

Competent Medical Laboratory Technicians, Technologists and Scientists are responsible for implementing this test procedure.

The Head Microbiology is responsible for ensuring the effective implementation and maintenance of this procedure

### 7.8.4 Principle

Diarrhoea due to common bacterial enteric pathogens may be confirmed by culturing faecal

Samples on selective media and enrichment broth. This allows the multiplication of enteric pathogens while inhibiting the growth of intestinal normal flora.

### 7.8.5 Sample Requirements

Sample – Stool, rectal swab

Container - Sterile stool container

### 7.8.6 Equipment

Incubator, Microscope, Aerobic incubator jar, Refrigerator, Biosafety cabinet, Bunsen burner

### 7.8.7 Materials

Reagent	Consumables
1% aqueous sodium hippurate substrate.	Clean container (at least 30 ml capacity)
3% Hydrogen peroxide.	Sterile swabs
Antimicrobial discs	Glass slides and cover slips
Candles	Disposable gloves
Carbon dioxide generating packs.	Forceps
Control organisms	Marker pen
Identification Media: Citrate, Lysine Iron Agar, Sulphide Indole Motility agar, Triple Sugar Iron (TSI) agar, Urea medium, or API 20E strips.	<input type="checkbox"/> Match box
Microaerophilic gas generating packs.	<input type="checkbox"/> Sterile disposable petri dishes
Mueller-Hinton agar (susceptibility test agar)	<input type="checkbox"/> Wire loop
Nutrient agar (Non-selective media).	<input type="checkbox"/> Physiological saline
Oxidase reagent (NNN'-Tetra methyl-p-phenylenediamine dihydrochloride.	<input type="checkbox"/> Spirit

<p>Orange sticks (Applicator sticks)  0.85% Sodium chloride in distilled water.  <i>Salmonella</i> antisera: Polyvalent O Groups A-S,  Polyvalent H Phase 1 and 2.  <i>Salmonella typhi</i> antisera: O-9, H-d, Vi.</p> <p>Selective media:  Alkaline Peptone Water (APW),  Campylobacter selective blood agar with  Skirrow's selective supplement containing  trimethoprim, vancomycin, polymyxin B,  amphotericin B and cephalothin) or Karmali's  selective agar with Preston's selective  supplement containing polymyxin B,  trimethoprim, rifampicin and cycloheximide.  CIN media(Cefsulodin-Irgasan-Novobiocin) for  <i>Yersinia enterocolitica</i>  Desoxycholate Citrate Agar (DCA),  MacConkey Agar,  Selenite F broth,  Sorbitol MacConkey (SMAC) <i>E. coli</i> O157: H7  Blood agar Plate (BAP)  Thiosulphate Citrate Bile Salt Sucrose Agar  (TCBS),  Xylose Lysine Desoxycholate Agar (XLD),  <i>Shigella</i> polyvalent antisera groups: <i>Shigella</i>  <i>dysenteriae</i> type 1, <i>Shigella dysenteriae</i> type  2-10, <i>Shigella flexneri</i> 1-6, x, y, <i>Shigella boydii</i>  1-6, <i>Shigella boydii</i> 7-11, <i>Shigella boydii</i> 12-  15, <i>Shigella sonnei</i> Phase 1 &amp; 2.</p> <p>Transport media (e.g. Cary-Blair)  <i>Vibrio cholerae</i> antisera: <i>Vibrio cholerae</i> inaba  antiserum, <i>Vibrio cholerae</i> O139 antiserum,  <i>Vibrio cholerae</i> ogawa antiserum, <i>Vibrio cholerae</i>  polyvalent O1 antiserum.</p>	
---	--

### **7.8.8 Storage and Stability**

Immediately after collection the sample should be sent to the laboratory.  
If delays in process occur, the sample should be kept at 2°C to 8°C

### **7.8.9 Safety**

Universal safety precautions should be taken into considerations and that all biological substances and reagents should be treated as potentially infectious.

### **7.8.10 Calibration**

Not Applicable

### **7.8.11 Quality Control**

Quality control of media and reagents when new lot prepared

### **7.8.12 Procedural Steps**

#### **Day 1**

- For *E. coli*, *Salmonella* and *Shigella*
- Inoculate a small portion of stool directly onto DCA, XLD, and MacConkey agar using an applicator stick.
- Streak using a wire loop and incubate at 37°C for 18-24 hours.
- Inoculate about 1 gram of stool into Selenite F broth, incubate overnight at 37°C.
- If cholera is suspected
- Inoculate on TCBS agar and Blood agar Plate (BAP) and streak using a wire loop and incubate at 35 + 2°C for 18-24 hours aerobically.
- Inoculate in Alkaline Peptone Water (APW) and incubate aerobically at 35 + 2 oC
- Subculture a loop full from the surface of the APW onto TCBS and BAP after 4 – 6 hours incubation.

#### **Day 2**

- *E. coli*, *Salmonella* and *Shigella*
- Examine DCA, XLD and MacConkey plates for, *Salmonella* and *Shigella* colonies. If there are any suspicious colonies (refer to Colony identification guidelines below), perform the following biochemical tests: TSI, LIA, SIM, Urease, Citrate, Oxidase or API 20E.
- In children under the age of two years, examine MacConkey plates for *E. coli* to rule out Enteropathogenic *E. coli* (EPEC) and other invasive strains of *E. coli*. Select 2 or more suspected *E. coli* colonies and set up a set of biochemical screening tests for each colony: TSI, LIA, SIM, Urease, Citrate, Oxidase or API 20E (Refer to ID004)
- Perform susceptibility testing following the Procedure for Antibiotic Susceptibility test, Bact-02
- If there is no growth of any suspected pathogen on DCA, XLD and MacConkey, subculture a loopful of Selenite F broth onto DCA and XLD and incubate at 35 + 2 oC for 18 – 24 hrs.

### **V. Cholera**

- Examine both the direct inoculated TCBS plate and BAP and the sub cultured plates for *V. Cholera*.
- Note: If there are mixed colonies, sub culture suspected colonies on TCBS and BAP to obtain pure cultures.
- Set up biochemical tests (TSI, LIA, SIM, Urease, Citrate, Oxidase or API 20E on suspected isolated colonies.

**Note: Perform the Oxidase test from colonies on BAP and NOT from TCBS plate.**

- Perform susceptibility testing following Procedure for Antibiotic Susceptibility test,
- Subculture all suspected *V. Cholerae* colonies onto non-selective media (e.g. Mueller Hinton) for subsequent serological tests the following day.
- DO NOT subculture *V. cholerae* on Nutrient agar for subsequent serological tests.
- Note: Work only on isolated colonies. If the colonies are not perfectly isolated, subculture any one of the suspicious colonies and proceed with the procedure after 18 – 24 hours growth of isolated colonies.

### Day 3

- *E. coli*, *Salmonella* and *Shigella*
- Read the set biochemical tests (Point 1 on Day 2) and identify the pathogen.
- Record the identification biochemical tests on Microbiology culture worksheet
- Report the susceptibility test results.
- For sub cultured colonies (Point 4 on Day 2), set up biochemical tests (TSI, LIA, SIM, Urea and Citrate or API 20E) on suspected *E. coli*, *Shigella* or *Salmonella*.
- Perform susceptibility testing following Procedure for Antibiotic Susceptibility Testing.
- Subculture all suspected *E. coli*, *Shigella*, *Salmonella*, onto non-selective media (e.g. Mueller Hinton) agar for subsequent serological tests the following day.

### ***V. cholerae***

- Read the biochemical tests and identify the pathogen.
- Record the identification biochemical tests on Microbiology culture worksheet
- Report isolates identified as *V. Cholerae* by serotyping and report susceptibility results.
- If the colonies were sub cultured (point 1 on day 2),
- Examine both the direct inoculated TCBS plate and BAP and the sub cultured plates for *V. Cholerae*.
- Set up biochemical tests (TSI, LIA, SIM, Urease, Citrate, Oxidase or API 20E) on suspected isolated colonies.

**Note: Perform the Oxidase test from colonies on BAP and NOT from TCBS plate.**

- Perform susceptibility testing following Procedure for Antibiotic Susceptibility testing
- Subculture all suspected *V. Cholerae* colonies onto non-selective media (e.g. Mueller Hinton) for subsequent serological tests the following day.

### Day 4

*Salmonella*, *Shigella* and *V. Cholerae*

Read the biochemical tests (point 2 on Day 3) for *Salmonella* and *Shigella* results set up on Day 3.

Report the susceptibility test results for *Salmonella*, *Shigella* and *V. cholerae*.

## **COLONY IDENTIFICATION GUIDELINES**

Media Colony Identification

XLD Agar Shigella and Salmonella produce clear transparent 1 – 2 mm diameter colonies that may assume the colour of the media (red). Most Salmonella produce red colonies with black centre.

MacConkey agar

E. coli produce magenta 3 – 4 mm diameter, flat colonies.

Salmonella and Shigella produce clear colourless 2–3 mm diameter convex colonies with smooth edges.

Thiosulphate – Citrate Bile Salt sucrose agar (TCBS) V. cholerae produce translucent, yellow, 2 – 3 mm diameter, flat colonies with entire smooth edges on TCBS.

### **7.8.13 Biological Reference Intervals**

- Not Applicable

### **7.8.14 Interpretation and Reporting of Results**

Record the results on Microbiology culture worksheet

Only report the presence or absence of organisms investigated:

**Example:**

**If pathogen present report as follows:**

*Salmonella* spp. isolated.

*Salmonella typhi* isolated

*Shigella boydii* isolated

*Vibrio cholerae* isolated

**If pathogen not present report as follows:**

No *Salmonella* isolated, or

No *Shigella* isolated.

No *Vibrio cholerae* isolated

**Critical value**

Isolation of *Vibrio cholerae* should be treated as a medical emergency and clinicians must be put on high alert.

### **7.8.15 Limitation of the Procedure and Sources of Errors**

- Delay in sample processing of more than 2 hrs after sample collection affects viability of
- enteric pathogens such as *E. coli*, *Salmonella*, *Shigella* and *V. cholerae*.
- Inadequate samples or poor quality of sample y (samples collected in dirty containers)
- Use of old or media with little moisture affects the recovery of enteric pathogens.

### **7.8.16 Performance Characteristics**

Refer to the method verification of this procedure

### **7.8.17 Supporting Documents**

Sample collection manual

### **7.8.18 References**

- Baker, F and Silvertone, R.E (1985). Introduction to Medical Laboratory Technology (6th edition). Butterworths, London
- Baker, F.J (1980) Medical Microbiological Techniques. Butterworths, London.
- Barrow, G.I and Feltham, R.K.A (1993). Cowan and Steel's manual for identification of medical bacteria (3rd edition). Cambridge University Press, Great Britain.
- Cheesbrough, M (2000). Medical Laboratory Manual for Tropical Countries (Vol. II). Butterworth-Heinemann, London.
- Collee, J.G, Fraser, A. G, Marmion, B. P and Simmons, A (1996). Mackie and McCartney Practical Medical Microbiology (14th edition). Churchill-Livingstone, London.
- Hawkey, P.M., and Lewis, D.A. (1989). Medical Bacteriology
- Isenberg, H. D (1992). Clinical Microbiology Procedures Handbook (Vol. 1 & 2). American Society of Microbiology, Washington, DC
- Murray, P. R, Baron, E. R, Pfaller, M. A, Tenover, F.C and Tenover, R. H (1995) Manual of Clinical Microbiology (6th edition). American Society for Microbiology, Washing, DC.
- Winn,C.W. Jr et al (2006). Koneman's color atlas and textbook of diagnostic microbiology (6th edition). Lippincott Williams and Wilkins. Philadelphia.

## 7.9 UROGENITAL SAMPLES/URETHRAL SWAB CULTURE

### 7.9.1 Purpose

This procedure provides instructions for processing urogenital samples (Urethral)

### 7.9.2 Scope

The procedure is used in the Bacteriology section when investigating for sexually transmitted infections (STI)

### 7.9.3 Responsibility

Competent Medical Laboratory Technicians, Technologists and Scientist are responsible for implementing this test procedure.

The Head Microbiology is responsible for ensuring the effective implementation and maintenance of this procedure.

### 7.9.4 Principle

The urogenital tract of males apart from the urethra is sterile. The cervix, uterus, fallopian tubes and ovaries are sterile sites. Isolation of microorganisms from such sterile sites is indicative of an infection. Infection of the urogenital tract (UGT) induces inflammatory reactions that lead to increased WBC collection. Microorganisms responsible for the urogenital tract infections often occur in predominant numbers in the presence of WBC and may be demonstrated by microscopy and/or culture examination of urogenital tract samples. Presence of some microorganisms such as *Neisseria gonorrhoea* and *Chlamydia* is always indicative of an infection.

### 7.9.5 Sample Requirements

Urogenital Swabs (High vaginal swab, urethral swab) are collected into amies transport media.

Avoid contaminating the samples with normal flora of the urogenital tract when collecting samples. Use of a speculum when collecting samples from the female genital tract limits contamination from normal flora. Urogenital samples include Urethra, High Vaginal, vulval swab, Endo-cervical swabs, and other samples from the upper female genital tract and the urethra or prostate secretions from male patients. It is of prime importance that samples are transported to the laboratory immediately. Where delay is anticipated inoculate samples on culture plates directly or use transport media (e.g. Amies' or Stuart's).

Samples from patients with suspected puerperal sepsis or septic abortion should be treated as wound samples.

### 7.9.6 Equipment

Incubator, Microscope, Aerobic incubator jar, CO2 Incubator or Candle, Biosafety cabinet, Bunsen burner

### 7.9.7 Materials

Reagent	Consumables
---------	-------------



Antimicrobial susceptibility discs Biochemical reagents, Control organisms <i>Neisseria gonorrhoea</i> (GC) media (e.g. Modified Thayer-Martin agar or New York City agar, Chocolate agar, Blood agar, MacConkey agar, Mueller-Hinton Agar, Sabouraud Dextrose agar (Appropriate selective media may be used when clinically indicated).	Glass slides Glass cover slips Gram Stain reagents Identification discs Petri dishes (Sterile disposable) Physiological saline Forceps, Marker pen, Oil immersion, Gloves, Sterile swabs, Wire loop
--	---

### 7.9.8 Storage and Stability

Where delay is anticipated inoculate samples on culture plates directly or use transport media (e.g. Amies' or Stuart's).

### 7.9.9 Safety

- i. Decontaminate working surfaces as recommended by IPC Guidelines.
- ii. Adhere to safety precautions as stated in the Safety manual.
- iii. All personal protective equipment (PPE) must be worn when performing this procedure.
- iv. All samples must be regarded as potentially infections.
- v. Avoid any contact between hands and eyes and nose during sample collection and testing.
- vi. Do not use kit beyond the expiration date which appears on the package label or device in a damaged pouch.
- vii. All spills should be wiped thoroughly using 1% sodium hypochlorite solution.

### 7.9.10 Calibration

Not applicable

### 7.9.11 Quality Control

Sterility and performance check should be done following preparation of media.

### 7.9.12 Procedural Steps

#### Day 1. Culture

- a. Inoculate the sample onto GC selective media, 2 blood agar plates, chocolate agar and MacConkey agar, Sabouraud's agar and where necessary into enrichment broth.
- b. Incubate the enrichment broth at 35 + 2°C for 18 – 24 hrs.
- c. Incubate one blood agar and MacConkey agar plates aerobically at 35 + 2°C for 18 – 24 hrs.
- d. Incubate another blood agar, chocolate agar and GC selective media plates at 35 + 2°C in 5% CO<sub>2</sub> for 18 – 24 hrs.
- e. Record all the above actions on Microbiology culture worksheet

### Microscopy

- a. Prepare wet preparations on all urethral and high vaginal swabs within 30 minutes of collection.
- b. Examine the preparation (using x 10 or x 40 objective) for WBC, RBC, yeast cells, clue cells and *Trichomonas vaginalis*, and report the findings on Microbiology culture worksheet, CPL TF 031
- c. Make a smear and perform gram stain (refer to Procedure for gram stain)
- d. Examine the Gram stain smear and report the findings. Rule out the presence of gram-negative intracellular diplococci that might be gonococci and clue cells (epithelial cells with lots of bacteria attached to them).
- e. In Suspected cases of chancroid look for Gram negative *coccobacilli* that show bipolar staining which may be in pairs or groups or in chains lying in parallel “school of fish” or “railway tract.”
- f. Giemsa stain can be employed in suspected cases of:
- g. *Chlamydia trachomatis*: Examine smears for *C. trachomatis* inclusion bodies (Blue-mauve reticulate bodies) lying within the cytoplasm of epithelial cells.
- h. *Calymmatobacterium granulomatis*: Look for epithelial cells that contain dark red staining rods of *C. granulomatis* (sometimes called Donovan bodies) and lots of gram negative rods.

## Day 2. Reading culture plates

- a. Examine aerobic plates for possible pathogens and set up/perform appropriate biochemical tests. If the organism is identified, report the identified organism (Refer to Identification flow Chart/Biochemical tests for microorganisms)
- b. Perform susceptibility testing following Procedure for antibiotic susceptibility testing,
- c. Re-incubate all culture plates with no growth for another 18 – 24 hrs under conditions defined in Day 1 above.
- d. Subculture from enrichment broth onto appropriate media and proceed as described under culture, steps 1 to 5, on Day 1.

**Note:** Do not leave plates on the bench for too long as *Neisseria gonorrhoea* will not survive longer at room temperature.

## Day 3. Reading biochemical tests

- a. Read the biochemical tests and susceptibility plates.
- b. Report the identified organism and susceptibility results.
- c. Record the identification biochemical tests on Microbiology culture worksheet,
- d. Examine the re-incubated aerobic plates for possible pathogens
- e. Set up/perform appropriate biochemical tests and susceptibility tests as on Day 2 and read the following day.

### 7.9.13 Limitation of the Procedure and Sources of Error

- a. Taking antibiotics prior to sample collection may affect the recovery of microorganisms.

- b. Poor staining techniques may give rise to false results.
- c. Delay in transportation and processing of samples may affect the recovery of microorganisms.

#### **7.9.14 Biological Reference Intervals**

Not applicable

#### **7.9.15 Interpretation and Reporting of Results**

- **For culture:**
- Report the pathogen isolated and the antimicrobial susceptibility pattern. In case of urethral, cervical, endometrium scrapings samples and other samples from normally sterile sites of the urogenital tract, report all cultures with no growth as "No growth".
- For the vaginal sample cultures where no pathogen is isolated report as "Normal flora isolated."
- **For wet preparation:**
- For WBC, RBC and epithelial cells, report actual numbers seen per high power field (x40).
- Report presence or absence of *Trichomonas vaginalis* and yeasts

#### **For gram stain:**

- a. Report any organisms seen
- b. If there are no organisms seen report as "No organisms seen"
- c. Report any clue cells seen
- d. Report on absence of gram positive long rods (*Lactobacillus*)(if that is the case)
- e. Report on presence of gram variable rods (*Gardnerella*).

#### **Results interpretation**

Demonstration of intracellular Gram-negative diplococci in a Gram stain and culture is indicative of gonococcal infection.

Isolation of *Streptococcus agalactiae* (Group B *Streptococcus*) from the vagina is significant and carriers must be treated.

The presence of abundant yeast cells in urogenital samples is indicative of fungal infection.

Presence of clue cells plus lack of *Lactobacilli* (gram positive long rods) being replaced by gram variable rods is indicative of bacterial vaginosis (BV).

#### **7.9.16 Limitation of the Procedure and Sources of Errors**

Taking antibiotics prior to sample collection may affect the recovery of microorganisms.

Poor staining techniques may give rise to false results.

Delay in transportation and processing of samples may affect the recovery of microorganisms.

#### **7.9.17 Performance Characteristics**

Refer to method verification report

### **7.9.18 Supporting Documents**

Sample collection manual

### **7.9.19 References**

- a. Barrow, G.I and Feltham, R.K.A (1993). Cowan and Steel's manual for identification of medical bacteria (3rd edition). Cambridge University Press, Great Britain.
- b. Cheesbrough, M (2000). Medical Laboratory Manual for Tropical Countries (Vol. II). Butterworth-Heinemann, London.
- c. Collee, J.G, Fraser, A. G, Marmion, B. P and Simmons, A (1996). Mackie and McCartney Practical Medical Microbiology (14th edition). Churchill-Livingstone, London.
- d. Hawkey, P.M., and Lewis, D.A. (1989). Medical Bacteriology
- e. Isenberg, H. D (1992). Clinical Microbiology Procedures Handbook (Vol. 1 & 2). American Society of Microbiology, Washington, DC
- f. Murray, P. R, Baron, E. R, Pfaller, M. A, Tenover, F.C and Tenover, R. H (1995) Manual of Clinical Microbiology (6th edition). American Society for Microbiology, Washing, DC.
- g. Winn,C.W. Jr et al (2006). Koneman's color atlas and textbook of diagnostic microbiology (6th edition). Lippincott Williams and Wilkins. Philadelphia.
- h. Baker, F and Silvertone, R.E (1985). Introduction to Medical Laboratory Technology (6th edition). Butterworths, London
- i. Baker, F.J (1980) Medical Microbiological Techniques. Butterworths, London.

## **7.10 MANUAL BLOOD CULTURE**

### **7.10.1 Purpose**

This procedure provides instructions for processing a blood culture using a manual method.

### **7.10.2 Scope**

This procedure applies to all blood cultures in isolation of bacterial pathogens.; it also applies in situations where automated blood culture system is not functioning or blood culture vials stock out or machine breakdown

### **7.10.3 Responsibility**

Trained and competent medical laboratory scientists /technologists are responsible in implementing this procedure.

### **7.10.4 Principle**

The culture of micro-organism from blood is essential in the laboratory diagnosis of bacteraemia, septicaemia, infective endocarditis and many infective conditions associated with a clinical presentation of pyrexia of unknown origin (PUO). Blood cultures may also detect bacteraemia in association with other infectious diseases such as septic arthritis and pneumonia. Early positive results provide valuable diagnostic information on which appropriate antimicrobial therapy can be based.

The detection of bacteraemia and fungaemia requires a good blood culture system complemented by good laboratory practice and communication.

Blood culture systems should aim to achieve the following:

A culture medium should be as rich as possible to allow the recovery of very small numbers of a variety of fastidious organisms

Neutralization or removal of antimicrobial substances, either natural blood components or antimicrobial agents.

A defined volume of blood is inoculated into a defined amount of broth. A blood to broth ratio of about 1:5 is normally required to remove the antibacterial effect from blood. Routine blood cultures will be subsequently incubated at 35 to 37°C and re-checked intermittently up to 7 days.

### **7.10.5 Sample Requirements**

- a. Blood should be collected as soon as possible after the onset of clinical symptoms.
- b. Blood should be collected before administrations of antibiotics. If the patient is already on antimicrobial therapy blood sample should be collected immediately before administering the next dose.
- c. Treatment of critically ill patient should not be delayed.
- d. Samples is collected in manual prepared blood culture vials.
- e. Use aseptic technique during sample collection, to avoid introduction of skin normal flora.
- f. Wash the skin with soap and water if necessary.

- g. Decontaminate with povidone or chlorhexidine.
- h. Clean the skin with alcohol.
- i. Do not re-palpate the vein after cleaning.
- j. Decontaminate septum of bottle with alcohol;
- k. The amount of blood sample to be inoculated into vials will depend on manufacturer instruction recorded outside the bottle.
- l. To reduce contamination and increase yield of bacteria isolation, it is best to collect two culture bottles from different sites.
- m. Blood Collection Set e.g. vacutainer or other tubing “butterfly” set may be used.
- n. Mix well by gentle tilting the vial 8 to 10 times.

### 7.10.6 Equipment

- Incubator

### 7.10.7 Materials

Reagent	Consumables
10 ml of Brain heart infusion broth, BHI/Tryptone soya broth, TSB (for adult)	Slides
5 ml of brain heart infusion broth, BHI /Tryptone soya broth, TSB (for paediatric)	Disposable loop
Gram Stain kit	Candle jar/carbon dioxide incubator
Blood agar	
Chocolate Agar	
MacConkey Agar(MAC)	

### 7.10.8 Storage and Stability

Immediately after collection the sample should be sent to the laboratory.

If delays in process occur, the sample should be kept at 35°C to 37°C incubator (blood culture bottles should never be refrigerated or frozen).

### 7.10.9 Safety

- a. Decontaminate working surfaces as recommended by IPC Guidelines.
- b. Adhere to safety precautions as stated in the Safety manual.
- c. All personal protective equipment (PPE) must be worn when performing this procedure.
- d. All samples must be regarded as potentially infections.
- e. Avoid any contact between hands and eyes and nose during sample collection and testing.
- f. Do not use kit beyond the expiration date which appears on the package label or device in a damaged pouch.
- g. All spills should be wiped thoroughly using 1% sodium hypochlorite solution.

### 7.10.10 Calibration

Not applicable

### 7.10.11 Quality Control

Quality control of media preparation (refer to procedure for Quality control of prepared media)

Quality control of Gram Staining using known strains (ATCC strains) *E. coli* ATCC 25922 as gram negative and *S. aureus* ATCC 25923 as gram positive

#### **7.10.12 Procedural Steps**

Perform both Gram stain and blind-subculture after 24 hours of incubation

Subculture on Blood agar, MacConkey agar and Chocolate agar

If there is bacterial growth after 24 hours, perform identification of organisms and set antimicrobial susceptibility testing.

If no bacterial growth after 24 hours' monitors cultures daily for 7 days by observing for **turbidity**, **haemolysis** and **flocculation**. Subculture if any changes are observed. Finally do blind-subculture on day 6 on Blood agar, MacConkey agar and Chocolate agar.

#### **7.10.13 Biological Reference Intervals**

Not Applicable

#### **7.10.14 Interpretation and Reporting of Results**

Report morphology of Gram negative or Gram-positive organism from Gram staining reaction to clinician immediately

If there is a growth of Gram negative *Enterobacteriaceae* in MCA or Gram-positive bacteria in Blood Agar or Chocolate Agar, report as preliminary results to clinician immediately while proceeding with identification of pathogen and antimicrobial susceptibility testing.

If no growth after 7 days of incubation: Report as "no growth of bacteria or fungal after 7 days of incubation"

#### **Common possible pathogens in blood**

<b>GRAM POSITIVE BACTERIA</b>	<b>GRAM NEGATIVE BACTERIA</b>
<i>Staphylococcus aureus</i>	<i>E. coli</i> ,
Coagulase-negative <i>Staphylococcus</i>	<i>K. pneumoniae</i>
Viridans group streptococci	<i>Neisseria meningitidis</i>
<i>Streptococcus pneumoniae</i>	<i>Pseudomonas aeruginosa</i>
<i>Streptococcus pyogenes</i>	<i>Haemophilus influenzae</i>
<i>Streptococcus agalactiae</i>	<i>Salmonella</i> spp.
<i>Enterococcus faecalis</i>	

**Note:** The pathogenic role of "commensal" isolates (e.g. *Staphylococcus epidermidis*) may be confirmed if they are recovered from multiple venepunctures or the patient has a long standing indwelling devices e.g. central venous lines, cardiac catheters, and shunts

Gram negative bacteria should be communicated as preliminary results to the requester

#### **7.10.15 Limitation of the Procedure and Sources of Errors**

Inaccurate amount of blood to broth ratio (too much or too little) will lead to false results. Contamination from prepared media will lead to false results

#### **7.10.16 Performance Characteristics**

Refer to method verification reports

#### **7.10.17 Supporting Documents**

Sample collection manual

#### **7.10.18 References**

- Mackie & McCartney, Churchill Livingstone **Practical Medical Microbiology**; 14th Edition, 1996.
- Manual of Clinical Microbiology 8th Edition Vol. 2, 2010 by Patrick R. Murray, Ellen Jo Baron, James H. Jorgensen, Michael A. Pfaller and Robert H. Yolken
- Blood culture: A key investigation for diagnosis of blood stream infections, Biomerieux
- CLSI Guidelines, Principles and Procedures for Blood Cultures; Approved Guidelines.M47-A, Vol. 27 No. 17, May 2007
- Vandepitte et al., Basic laboratory procedures in clinical bacteriology. 2nd edition. World Health Organization, Geneva, Switzerland, 2003



## **7.11 AUTOMATED BLOOD CULTURE BD BACTEC FX40**

### **7.11.1 Purpose**

- This Standard Operating Procedure (SOP) is aimed to describe step by step on how to operate the BD BACTEC FX40 analyser using blood sample.

### **7.11.2 Scope**

This test procedure will be used for susceptibility testing of all pathogens isolated during culture in Microbiology units.

### **7.11.3 Responsibility**

Trained, qualified and competent health laboratory practitioners are responsible for performing this procedure.

The head of section for chemistry is responsible for ensuring the effective implementation and competency assessment for this procedure

### **7.11.4 Principle.**

The detection of microorganisms in a patient's blood has diagnostic and prognostic Importance. Blood cultures are essential in the diagnosis and treatment of the etiologic agents of sepsis. Bacterial sepsis constitutes one of the most serious infectious diseases and, therefore, the expeditious detection and identification of blood borne bacterial pathogens is an important function of the diagnostic microbiology laboratory. The BACTEC FX40 series of blood culture instruments are designed for the rapid detection of microorganisms in clinical samples. The sample to be tested is inoculated into the vial which is entered into the BACTEC FX40 instrument for incubation and periodic reading. Each vial contains a sensor which responds to the concentration of CO<sub>2</sub> produced by the metabolism of microorganisms or the consumption of oxygen needed for the growth of microorganisms. The sensor is monitored by the instrument every 10 minutes for an increase in its fluorescence, which is proportional to the increasing amount of CO<sub>2</sub> or the decreasing amount of O<sub>2</sub> present in the vial. A positive reading indicates the presumptive presence of viable microorganisms in the vial.

### **7.11.5 Sample Requirements**

If using a needle and syringe, typically a 10 mL syringe is used for adults. Draw 8 to 10 mL of blood for one blood culture set (aerobic). Aseptically inject 8 to 10 mL of sample into vial

For paediatric patients, a 3 mL syringe is frequently used. Draw 1 to 3 mL of blood and transfer the entire amount into BACTECT™ PEDS PLUS/F vial.

### **7.11.6 Equipment**

- Incubator, Biological Safety Cabinet, Autoclave , Microscope,

### **7.11.7 Materials/REAGENTS**

#### **Material**

- Syringe 10cc
- Syringe 5cc

- Syringe 2cc
- 70% isopropyl alcohol (alcohol pads)

#### **Reagents**

- BACTEC PLUS Aerobic/F Culture Vial
- BACTEC PEDS PLUS/F Culture Vial

#### **7.11.8 Storage and Stability**

- **Reagents:** Store according to manufacturer's specifications
- **Kits:** Refer to manufacturer's specifications.
- **Handling:** Always wear personal protective equipment (PPE).

#### **7.11.9 Safety**

- Decontaminate working surfaces as recommended by IPC Guidelines
- All personal protective equipment (PPE) must be worn when performing this procedure.
- All samples must be regarded as potentially infectious.
- Refer to National infection prevention and control Guidelines for healthcare services in Tanzania, February 2007.

#### **7.11.10 Calibration**

Equipment calibration is conducted by the user or biomedical engineer when needed. Run the internal quality control samples to verify the performance of the machine.

#### **7.11.11 Quality Control**

Each case of media has a Quality Control certificate indicating the organisms tested and the acceptability of those tests.

The laboratory should test each shipment of media for performance through the use of a positive and negative vial test. The positive vial should be inoculated with 1.0 mL of a 0.5 McFarland Standard of either *Escherichia coli* or *Staphylococcus aureus* prepared from a fresh 18 - 24 hrs culture. This vial and an inoculated vial should be logged into the instrument and tested. The inoculated vial should be detected as positive by the instrument within 72 hours. The negative control vials should remain negative throughout the entire testing protocol. This verifies that the media were not subject to adverse storage or shipping conditions prior to receipt in the laboratory. If either of these vials does not give the expected results, do not use the media until you have contacted supplier.

#### **7.11.12 Procedural Steps**

##### **a) Daily maintenance**

<b>Step</b>	<b>Action</b>
	<b>Each day the following check should be made</b>
<b>1</b>	<b>Temperature verification</b>
	Check the temperature readout on the LCD display on the instrument.

	Verify that the temperature is currently at 35 C ± 1.5 C. Also check the reading on the temperature Quality control vial if the reading are not 35 C ± 1.5 C, refer to the instruction for troubleshooting.
<b>2</b>	<b>Air Filter Replacement</b>
	Change or clean the air filters on both sides of the instrument monthly. Check the filters more frequently if the laboratory's environment is dusty.

**b) Operating BD BACTEC and sample collection**

<b>Step</b>	<b>Action</b>
	<b>SAMPLE COLLECTION</b>
<b>1.</b>	<b>SITE SELECTION</b> <ol style="list-style-type: none"> <li>1. Select a different body site for each culture drawn.</li> <li>2. Avoid drawing blood through indwelling intravascular catheters unless blood cannot be obtained by venepuncture. Blood collected from intravascular catheters should be done with the knowledge that contamination may be an issue.</li> </ol>
<b>2.</b>	<b>SITE PREPARATION (PERSIST Povidone Iodine Prep 10%)</b>
	Open the PERSIST package by tearing completely through at the side notches and twisting.
	Leave the package over the end of the swab stick to prevent gloves from becoming covered with solution.
	Apply PERSIST by beginning at the intended venepuncture site, working in a circular motion with friction, covering an area of 2-3 inches in diameter. Do not return to the centre of the site once swab has moved outward to the periphery. Persists should be applied with friction and the site prepped 30 seconds to 1 minute.
	Allow PERSIST solution to air dry. DO NOT touch or palpate the area after cleansing.
<b>3.</b>	<b>DISINFECTING BLOOD CULTURE VIALS-</b>
	Remove the flip-off caps from BACTEC culture vials.
	Wipe top of each vial with a separate 70% isopropyl alcohol pad and allow drying.
	Do not use iodine to disinfect tops of vials.
<b>4.</b>	<b>VENIPUNCTURE</b>
	Avoid touching the venepuncture site. If it is necessary to touch the site after it has been cleaned, wipe your fingers with Povidone iodine before touching the site.
	When using the Blood Collection Set ("butterfly") the phlebotomist MUST carefully monitor the volume collected by using the 5 mL graduation marks on the vial label. If the volume is not monitored, the stated maximum amount collected may be exceeded. This condition may adversely create a 'false' positive result, due to high blood background.

	<p>If using a needle and syringe, typically a 10 mL syringe is used for adults. Draw 8 to 10 mL of blood for one blood culture set (aerobic). Aseptically inject 8 to 10 mL of sample into vial.</p> <p>For paediatric patients, a 3 mL syringe is frequently used. Draw 1 to 3 mL of blood and transfer the entire amount into BACTECTM PEDS PLUS/F vial.</p> <p>After all samples have been collected from the individual, use a sterile alcohol pad to remove the Povidone-iodine solution from the venepuncture site.</p>
<b>5.</b>	<b>THE INOCULATED BACTEC VIALS SHOULD BE TRANSPORTED AS QUICKLY AS POSSIBLE TO THE LABORATORY.</b>
	<p>The volume of blood cultured is critical because the number of organisms per mL of blood in most cases of bacteraemia is low, especially if the patient is on antimicrobial therapy. In infants and children, the number of organisms per mL of blood during bacteraemia is higher than adults, so less blood is required for culture</p>
<b>6.</b>	<b>SAMPLE LABELING</b>
	<p>Each vial should be labelled with the appropriate patient information:</p> <ul style="list-style-type: none"> <li>• Patient's name</li> <li>• Hospital number (Patient ID)</li> <li>• Ward</li> <li>• Date and time of collection</li> <li>• Collector's initials</li> </ul> <p>Each request slip should also have all the information above.</p>
<b>7</b>	<b>NUMBER AND TIMING</b>
	<p>Most cases of bacteraemia are detected using two to three sets of separately collected blood cultures. More than three sets of blood cultures yield little additional information. Conversely, a single blood culture may miss intermittently occurring bacteraemia and make it difficult to interpret the clinical significance of certain isolated organisms</p>
<b>8</b>	<b>PROCESSING NEW BLOOD CULTURES ENTERING DATA AND LOADING INSTRUMENT</b>
	<p>To enter vials in the instrument, select a drawer where there are available stations. (The number of available stations is shown below the "vial entry" icon on the Status display.)</p> <p>Then follow one of the two methods described below;</p>
	<b>Method 1 (Vial Activated)</b>

- I. Select a drawer that has available stations, and open that drawer.
- II. The barcode scanner turns on.
- III. Scan a vial sequence barcode label.
- IV. The Vial Entry display appears and the Sequence, Media, and default Protocol are automatically entered.
- V. If you did not scan the Accession, scan or enter it now
- VI. To change the protocol, tap the “modify” button, then tap the up arrow to increase or down arrow to decrease the protocol length.
- VII. Place the vial into an available station (solid green indicator).

#### Method 2 (Icon Activated)

- i. Select a drawer that has available stations, and open that drawer
- ii. Tap the “vial entry” button on the Status display
- iii. The Vial Entry display appears and the barcode scanner turns on
- iv. Scan the vial sequence barcode label
- v. The Sequence, Media, and default Protocol are automatically entered
- vi. If you did not scan the Accession, scan or enter it now
- vii. To change the protocol tap the “modify” button, then tap the up arrow to increase or down arrow to decrease the protocol length
- viii. Place the vial into an available station (solid green indicator)
- ix. When a vial is placed into the last available station in a drawer, the Activity Complete tone sounds (3 beeps).
- x. To continue entering vials, select another drawer with available stations.

#### **Inserting Vials in the Instrument**

Before inserting vials into the stations, visually inspect all vials for positives. Evidence of microbial growth includes hemolysis, turbidity, and excess gas pressure (causing the vial septum to bulge outward). All such vials should be treated as positives; they should be stained and sub cultured.

After all vials have been inspected and inserted in stations, close the drawer.

A vial presence sensor immediately senses the insertion of a vial in a station and the instrument updates the station LED indication and the status shown on the LCD.

Once vials are placed in their stations, you should avoid moving them to other stations unnecessarily.

Avoid opening the drawer unnecessarily. Drawers should not remain open longer than 10 minutes.

Make sure all vials are fully inserted in the stations before closing the drawer.

#### **ANONYMOUS VIAL ENTRY**

Vials can be placed into available (GREEN indicator) stations without being scanned into the instrument. Vials that are not scanned into the instrument are called

“anonymous” vials. Anonymous vials are recognized by the instrument when they are placed in stations, but are assigned an “unknown” medium type and default protocol of 5 days. Anonymous vials are evaluated with general positivity criteria. They cannot use the specific positivity criteria tied to the characteristics of the medium since the instrument does not know the medium type.

We recommend that at some point you identify these anonymous vials to the system using the ID(identify) Anonymous vials activity. The instrument is able to apply medium specific positivity criteria when the medium type is known, and can apply these specific criteria to collected test readings. In addition, the protocol is adjusted (if necessary) to the default for that medium type once the vial is identified.

**NOTE:** Once an anonymous vial has been placed in the instrument, do not remove the vial and re-enter it without identifying it (ID Anonymous activity). All test readings are discarded if you remove the vial without identifying it.

### **Positive and Negative Vials**

#### **A. Notification of positive and negative vials**

The system notifies you of new positive cultures in several ways:

- i. Positive Vial audible alarm sounds
- ii. Station Indicators: FLASHING RED or FLASHING AMBER / RED (alternating) -Anonymous Positive
- iii. Message box appears on screen
- iv. Positive vial system indicator for that drawer illuminates
- v. On the Status display, the “positives” icon is active (color is red, not grayed out) and the number of positive vials in the drawer is shown
- vi. Out-of-Protocol Negatives are indicated by the following:
- vii. Negative vial system indicator for that drawer illuminates
- viii. On the Status display, the “negatives” icon is active and the number of negative vials in the drawer is shown
- ix. Station indicators: FLASHING GREEN

#### **B. Removing positive vials**

- i. Select a drawer that has positive stations, and open the drawer by pulling it out.
  - a. The barcode scanner turns on.
  - b. All positive, final negative, available, and anonymous (all variations) are indicated by the appropriate lit or flashing station indicators.
  - c. Tap the “remove positives” button on the Status display,

OR

- d. Remove a vial from a FLASHING RED (positive) or FLASHING AMBER / FLASHING RED (anonymous-positive) station
  - e. The Positive Removal display appears. (If an anonymous positive vial was removed, the ID Anonymous display appears. Scan the sequence and accession for the anonymous positive vial and tap the “Save” button. Then tap the “Exit” button to return to the Positive Removal display.)
  - f. If the Show Related Vials function is enabled in configuration, the LEDs of vials with the same accession number illuminate GREEN (in the current drawer), and the Culture – Sample display shows the related vials in the Vial Window (not applicable to Positive / Anonymous vials).
- ii. Remove any related vials if desired, and either confirm or scan the sequence number (depending on the system prompt). When you have finished removing related vials, tap the “exit” key to return to the Positive Removal display

### **C. Removing negative vials**

Select a drawer that has negative stations, and open the drawer by pulling it out.

- a. The barcode scanner turns on. All positive, final negative, and anonymous (all variations) are indicated by the appropriate flashing station indicators.
- b. For Single Vial Removal
  - Tap the “remove negatives” button on the Status display, OR
  - Remove a vial from a FLASHING GREEN (negative) station and scan it.
  - The Negative Removal display appears.
  - Remove and scan all the negative vials. (If any vial sequence numbers were entered manually, the system asks you to verify that the sequence number is correct. You must manually confirm that the sequence number on the vial is the same as the one shown on the screen, and tap the “Verified” button.)
- c. For Batch Vial Removal
  - Remove the negative vials from the FLASHING GREEN station
  - These vials do not have to be scanned (and the scanner does not turn on). Any vials left in the instrument remain in the database as negatives.
  - Counters on the display are updated dynamically as vials are removed.
  - When all negatives are removed from the drawer, the “activity

	complete” tone sounds.
	<p><b>D. Processing Positive Vials</b></p> <p>a) Remove the vial from the instrument and place in a biological safety cabinet.</p> <p>b) Invert the vial to mix the contents.</p> <p>c) Observe “<b>Universal Safety Precautions</b>”</p> <p>d) Remove aliquot from the vial for stain preparations (Gram and/or Acid Fast Bacilli).</p> <p>e) Subculture vials according to the Gram stain and/or Acid Fast Bacilli stain results.</p> <p>f) Report preliminary results only after stain preparation.</p> <p>Perform identification and susceptibility of organism(s) grown on solid media according to your laboratory protocol.</p>

**7.11.13 Biological Reference Intervals**

Not Applicable

**7.11.14 Interpretation and Reporting of Results**

Media selected for the culture of blood should be capable of providing the fastest growth and isolation of as wide a range of pathogens as possible. The following media are recommended:

Blood Agar, Nutrient Agar, Hektone Agar, MacConkey Agar, EMB, and Chocolate Agar

<b>PATHOGEN ORGANISM</b>	<b>NOT PATHOGEN UNLESS RECORDED FROM &gt;1 SEPARATE BLOOD CULTURE</b>
<ul style="list-style-type: none"> <li>➤ Salmonella typhi</li> <li>➤ Salmonella serovars</li> <li>➤ Brucella</li> <li>➤ Klebsiella pneumonia</li> <li>➤ Acinetobacter baumannii</li> <li>➤ S. aureus</li> <li>➤ S. epidermidis</li> <li>➤ Pseudomonas aeruginosa</li> <li>➤ Enterococcus faecalis</li> <li>➤ S. pneumoniae</li> <li>➤ Proteus species</li> <li>➤ Bacteroides species</li> <li>➤ E. coli</li> <li>➤ Neisseria meningitidis</li> <li>➤ Yersinia pestis</li> <li>➤ Haemophilus influenza</li> <li>➤ Mycobacterium tuberculosis</li> <li>➤ Leptospira species</li> <li>➤ Borrelia species</li> </ul>	<ul style="list-style-type: none"> <li>➤ Bacillus sp</li> <li>➤ Coagulase - staph</li> <li>➤ S. viridans</li> <li>➤ S. pyogenes</li> <li>➤ Anaerobic streptococci</li> </ul>



<ul style="list-style-type: none"><li>➤ Bartonella bacilliformis</li><li>➤ Candida albicans</li><li>➤ Cryptococcus neoformans</li></ul>	
---	--

**7.11.15      *Limitation of the Procedure and Sources of Errors***

Blood does not have normal microbial flora common skin contaminants includes coagulase negative staphylococci viridans streptococci micrococci and Corynebacterium species.

For children and Immunocompromised patients, S. aureus and coagulase negative staphylococcus are regarded as Pathogenic

**7.11.16      *Performance Characteristics***

Refer the method verification reports of this procedure and equipment manufacturer user manual.

**7.11.17      *Supporting Documents***

Sample collection manual

**7.11.18      *References***

1. BACTEC FX40 User manual
2. District Laboratory Practice in Tropical Countries Part 2 Second Edition Monica Cheesbrough.
3. CLSI document
4. Package inserts

## 7.12 CEREBROSPINAL FLUID (CSF) ANALYSIS

### 7.12.1 Purpose

This procedure describes the standard steps for bacteriological processing of Cerebrospinal Fluid (CSF)

### 7.12.2 Scope

Used in Bacteriology section for processing CSF samples in the diagnosis of meningitis

### 7.12.3 Responsibility

Qualified and competent Medical Laboratory Practitioners are responsible for implementing this test procedure.

### 7.12.4 Principle

Bacterial meningitis is the result of infection of the meninges (lining around the brain). The presence of microorganism, WBC in numbers higher than normal values, or other abnormalities indicative of an infection of the central nervous system (CNS) is demonstrated by macroscopic, microscopic and culture examination of the CSF.

### 7.12.5 Sample Requirements

Collect 1ml of Cerebrospinal fluid in a plain sterile tube (red cap) No. 1 and about 2–3 ml in plain sterile tube no.2 collected before patient is given antibiotics.

The sample **MUST NOT** be refrigerated as this will kill fastidious organisms such as *Haemophilus spp* and *Streptococcus pneumoniae*. In case of inevitable delay, keep the sample at 35°C for not more than 2 hrs.

### 7.12.6 Equipment

Microscope, Biosafety cabinet, Bunsen burner, Centrifuge, 35°C to 37 °C Incubator, Candle jar and 2-8°C Refrigerator.

### 7.12.7 Materials

Reagent	Consumables
<ul style="list-style-type: none"><li>• Streptococcus Lancefield grouping kit.</li><li>• X, V and XV factors (paper discs)</li><li>• Ziehl-Neelsen stain, auramine phenol</li><li>• 2% acetic acid</li><li>• Methylene blue</li><li>• Culture media - Blood Agar; Chocolate Agar; Sabouraud Dextrose Agar; MacConkey Agar; Mueller Hinton</li><li>• India Ink or Nigrosin stain</li><li>• Counting chamber (e.g. Improved Neubauer chamber)</li><li>• Glass slides and cover slips</li></ul>	<ul style="list-style-type: none"><li>• Disposable gloves, Spirit, Wire loop, Sterile disposable Petri dishes, biohazard box</li><li>• Control organisms, Biochemical identification reagents,</li><li>• Cotton wool, forceps, match box, disposable gloves, physiological saline, marker pen</li></ul> <p>Plain sterile containers Sterile pipette and rubber tips</p>

<ul style="list-style-type: none"> <li>• Gram stain reagents</li> <li><i>Haemophilus influenzae</i> antisera types a, b, c, d, e and f mono-antisera</li> <li>Leishman stain/Giemsa stain</li> <li>Optochin disc</li> </ul>	
---	--

### 7.12.8 Storage and Stability

- The stability of the CSF sample varies depending on the procedures ordered. Cell counts are ALWAYS STAT and should be performed within 30 - 60 minutes for best results.
- Samples should be left at room temperature for no longer than one hour and refrigerated following testing.
- Refrigeration is not recommended for culture Samples since fastidious organisms such as *Haemophilus influenzae* and *Neisseria meningitidis* may not survive the cold temperature.

### 7.12.9 Safety

- Decontaminate working surfaces as recommended by IPC Guidelines
- Adhere to safety precautions as stated in the Safety manual
- All personal protective equipment (PPE) must be worn when performing this procedure.
- All samples must be regarded as potentially infections.
- Avoid any contact between hands and eyes and nose during sample collection and testing.
- Do not use kit beyond the expiration date which appears on the package label or device in a damaged pouch.
- The test device should be stored at 2 - 30°C. And the test should be performed at room temperature.

### 7.12.10 Calibration

All auxiliary equipment should be calibrated annually following calibration schedule

### 7.12.11 Quality Control

Quality control of media and reagents should be done when media and reagents preparation performed

Use known control positive of *Cryptococcus neoformans* slide and control negative slide

### 7.12.12 Procedural Steps

#### Day 1

Use the plain tube for describing macroscopic, culture and preparing smears for stains. The EDTA tube is used for cell counting. In case of only 1 plain tube of CSF start with culture before proceeding to microscopy.

#### Macroscopic Examination

Examine the CSF in the plain tube macroscopically for colour, turbidity, presence of blood and volume.

Also examine for the presence of spider web clot suggestive of TB meningitis.

### **Microscopic examination**

#### **Cell Count**

- a. Perform cell count on CSF from the sterile plain tube before spinning the sample, (taking caution not to contaminate it) using an Improved Neubauer counting chamber.
- b. Cell counting from plain sterile tube should be done within 30minutes of collecting the sample as the cells will start to deteriorate afterwards.
- c. Fix a glass cover slip No. 2 on top of the ruled area of the clean counting chamber until rainbow colors appear.
- d. Rainbow colors under the cover slip are indicative of a well fixed cover slip.
- e. Mix the sample thoroughly by tilting it back and forth.
- f. Using a sterile capillary tube take a volume of the sample and fill (charge) the chamber. Avoid formation of air bubbles and overflowing.
- g. Stand the chamber in a moist Petri dish on a flat surface for five minutes to allow cells to settle down.
- h. Place the chamber on the microscope and check for the ruled area under the x10 objective (Figure 1).
- i. Count the cells using the x10 or the x40 objective in the ruled area and report as indicated below.
- j. RBC when very numerous are best counted in the middle square labeled “**R**” and WBC when very few are best counted in the squares labeled “**W**.”
- k. If the cells are too many to count, dilute the CSF 1 in 10 ( 1 drop of c.s.f with 9 drops of diluting fluid), refill the chamber and count the cells.

For calculations see below.

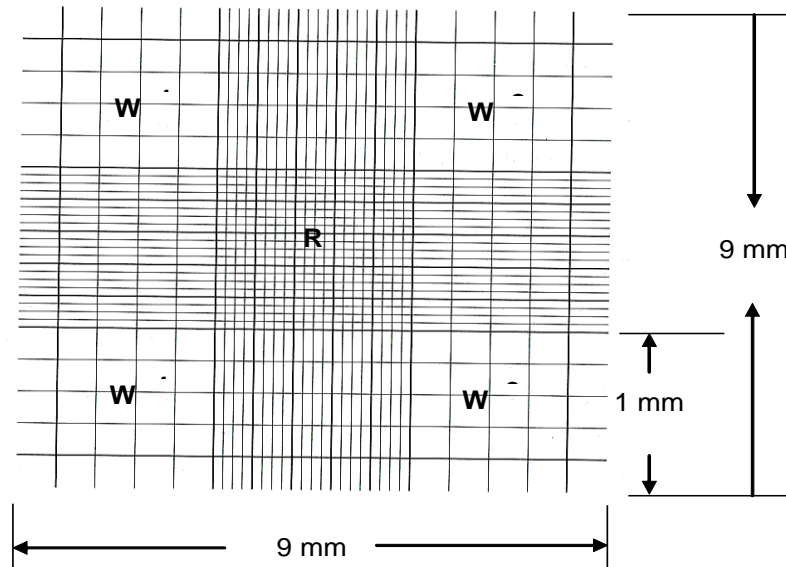

**Figure 1: Improved Neubauer counting chamber**  
**Differential Count**

- a. Perform a differential count when the WBC count is greater than  $5 \times 10^6/L$  ( $5\text{mm}^3$ ).
- b. Centrifuge the sample at 3000 rpm for 5 minutes.
- c. Tip off the supernatant and re-suspend the deposit well.
- d. Prepare a smear from the cellular deposit.
- e. Allow to air dry and fix the smear with methanol.
- f. Stain with Giemsa or Leishman stain.

Count the WBC and report the count of each WBC type as a percentage (See results section below).

### Culture

- a. Centrifuge the CSF in the plain tube at 3000rpm for 10 minutes and tip off the supernatant.
- b. Inoculate part of the sediment heavily onto chocolate agar, blood agar, MacConkey agar and Sabouraud's agar, preferably using a 10  $\mu\text{l}$  loop.
- c. Incubate blood agar and chocolate agar at 35 to 37°C in  $\text{CO}_2$  for 18 – 24 hrs. Incubate MacConkey and Sabouraud's agar aerobically at 35 to 37°C. Incubate MacConkey plates for 18 – 24 hrs and Sabouraud's agar for 24 hours in 35 to 37°C incubator and a further 24hours at room temperature.
- d. Use part of the sediment to make smears for Gram stain and Ziehl Neelsen (ZN) and a wet preparation for India ink or Nigrosin stain.

### Gram Stain

- a. Prepare a smear from the sediment of CSF from the plain tube.
- b. Allow to air dry.
- c. Fix the smear with methanol or with heat.
- d. Perform gram stain as per procedure

- e. Examine for microorganisms using x100 objective and report findings.

### India Ink or Nigrosin stain

- a. Put a drop of the sediment of CSF from the plain tube onto a glass slide and mix with a drop of India ink or Nigrosin stain.
- b. Place a glass cover slip on top and examine under the X10 or X40 objective for oval or round yeast cells surrounded by an unstained capsule.
- c. Report results as “*Cryptococcus* seen,” or “No *Cryptococcus* seen.”

### Ziehl-Neelsen Stain

For CSF with raised WBC count and predominance of lymphocytes make a smear as described for gram stain and stain with ZN stain or Auramine O stain procedure

Examine the stained smear for Acid Fast Bacilli (AFB).

### Day 2. Reading cultures

Examine the culture plates for growth after 18-24 hours and perform gram stain of the isolated pathogen and proceed to perform appropriate biochemical identification tests.

Perform susceptibility tests on all pure growths not deemed as contaminants

If there is no growth obtained, re-incubate the plates for another 18 – 24hours.

### Day 3. Bacterial identification

- a. Read biochemical tests using Refer *Identification flow Chart/Biochemical tests for microorganisms*
- b. Record the biochemical identification tests on Microbiology culture worksheet
- c. Report the findings.
- d. Examine the re-incubated plates for growth. If there is growth, proceed with the necessary identification and sensitivity tests as on day 2. If there is no growth report as “No Growth” and send the results.

### Calculations

#### Cell count calculations

If N cells are counted in 1 mm<sup>2</sup>, calculate the WBC count as follows:

$$\frac{N}{\text{Area} \times \text{Depth}} \times 10^6 / \text{L}$$

- Area x Depth = Volume (μL)

E.g.

$$\frac{N}{1 \text{ mm}^2 \times 0.1 \text{ mm}} \times 10^6 / \text{L}$$

$$\rightarrow \frac{N}{0.1 \text{ mm}^3} \times 10^6 / \text{L}$$

$$\rightarrow N \times 10 \times 10^6/L$$

NB: Both red and white cells should be counted.

If cells are too numerous to be counted dilute sample with saline and carry out the cell count as indicated above. Multiply the number of cells counted by the dilution factor in order to get the actual cell count of the neat CSF.

Dilute CSF samples containing numerous RBCs with 2% acetic acid tinted with methylene blue or crystal violet in a 1:1 ratio and count the WBC. The acetic acid will lyse RBCs.

•

### **7.12.13 Biological Reference Intervals**

From cell count

WBC:  $\leq 5$

RBC: 0

### **7.12.14 Interpretation and Reporting of Results**

- i. Blood-stained CSF samples may indicate traumatic lumbar puncture (i.e., if the second sample is less blood-stained).
- ii. If sample 1 and 2 are equally blood-stained that may be suggestive of subarachnoid haemorrhage in the CNS.
- iii. A xanthochromic (yellow) CSF is suggestive of subarachnoid haemorrhage, jaundice, or spinal constriction.
- iv. A clot in the CSF is suggestive of spinal constriction or pyogenic meningitis.
- v. In tuberculosis meningitis, the clot may form a web on the surface of the fluid if allowed to stand for several hours.
- vi. A turbid CSF sample is indicative of bacterial meningitis.
- vii. If the CSF contains a predominance of polymorphs, it is indicative of acute bacterial meningitis.
- viii. A predominance of lymphocytes in CSF is indicative of viral, TB or Cryptococcus meningitis.

### **Critical values**

A positive result for any of the investigations above is considered critical and **must** be communicated to the requesting clinician immediately.

### **7.12.15 Limitation of the Procedure and Sources of Errors**

- a. If aseptic procedures are not strictly adhered to in collection and processing of samples, cultures may yield contaminants.
- b. The technique described above will not isolate viruses or fastidious organisms such as Mycobacterium, Treponema and Leptospira.
- c. Administration of antimicrobial agents before CSF collection may affect the recovery of microorganisms in cultures.
- d. Delay in transportation and subsequent processing of CSF after collection may affect the recovery of microorganisms.

- e. Delay in subcultures or incubation of sub-cultured plates may affect the recovery of microorganisms

#### **7.12.16 Performance Characteristics**

refer to method verification reports

#### **7.12.17 Supporting Documents**

##### **Sample collection manual**

Safety manual

Quality manual

#### **7.12.18 References**

- JICA (2004). Manual of Laboratory Procedures for clinical Microbiology
- Barrow, G.I and Feltham, R.K.A (1993). *Cowan and Steel's manual for identification of medical bacteria* (3<sup>rd</sup> edition). Cambridge University Press, Great Britain.
- Cheesbrough, M (1987). *Medical Laboratory Manual for Tropical Countries* (Vol. II). Butterworth-Heinemann, London.
- Isenberg, H. D (1992). *Clinical Microbiology Procedures Handbook* (Vol. 1 & 2). American Society of Microbiology, Washington, DC
- Murray, P. R, Baron, E. R, Pfaller, M. A, Tenover, F.C and Tenover, R. H (1995) *Manual of Clinical Microbiology* (6<sup>th</sup> edition). American Society for Microbiology, Washing, DC



## 7.13 CULTURE OF BODY FLUID OTHER THAN CSF (PLEURAL FLUID, PERITONEAL FLUID, AND SYNOVIAL FLUID)

### 7.13.1 Purpose

This procedure provides instructions for processing body fluids other than CSF for culture and sensitivity.

### 7.13.2 Scope

The procedure is used in the Bacteriology section whenever body fluids other than csf are received.

### 7.13.3 Responsibility

Qualified and competent Medical Laboratory Practitioners are responsible for implementing this test procedure.

The Head Microbiology is responsible for ensuring the effective implementation and maintenance of this procedure.

### 7.13.4 Principle

Body fluids (i.e. pleural fluid, peritoneal fluid, and synovial fluid) in enclosed body cavities are sterile. The presence of microorganisms in such serous cavities induces inflammation that leads to excessive accumulation of fluid and other inflammatory markers. Such microorganisms may be demonstrated by microscopy or culture examination of effusions produced during inflammation.

### 7.13.5 Sample Requirements

Samples are collected using a clean, sterile swab and sent in transport medium. If fluid is sent this is placed in a sterile container with a screw cap lid.

### 7.13.6 Equipment

Aerobic Incubator, Biosafety cabinet, Microscope, Refrigerator, Anaerobic jar 2-5% CO<sub>2</sub>

### 7.13.7 Materials

Reagent	Consumables
<ul style="list-style-type: none"><li>Antimicrobial susceptibility discs, Biochemical reagents, Control organisms, Gram staining kit or leishman, ZN stain reagents and Auramine phenol</li><li>Media; MCA, Chocolate, Blood agar, Mueller-Hinton Agar, Sabouraud agar (Appropriate selective media may be used when clinically indicated).</li><li>Broth:</li></ul>	<ul style="list-style-type: none"><li>Petri dishes (Sterile disposable)</li><li>Physiological saline</li><li>Sterile swabs, disposable gloves, match box, forceps, marker pen, spirit</li><li>Wire loop</li><li>Centrifuge tubes</li><li>Capillary tubes</li><li>Plain sterile containers</li><li>Sterile pipette and rubber tips</li><li>Glass slides</li></ul>

<ul style="list-style-type: none"> <li>• Cooked meat media, Thioglycollate broth</li> <li>• Tryptone soya broth</li> </ul>	<ul style="list-style-type: none"> <li>• Glass cover slips</li> </ul>
--	---

### 7.13.8 Storage and Stability

**Reagents:** store according to manufacturer's specifications.

The Sample **MUST NOT be refrigerated as this will kill fastidious organisms such as *Haemophilus spp.*** In case of delay, keep the Sample at 37°C for not more than 2 hrs.

### 7.13.9 Safety

- All personal protective equipment (PPE) must be worn when performing this procedure.
- All Samples must be regarded as potentially infections.
- Refer to National infection prevention and control Guidelines for healthcare services in Tanzania, February 2007.

### 7.13.10 Calibration

Not Applicable

### 7.13.11 Quality Control

Ensure that all media and supplies used have passed the required Quality control and are used within their expiry date

### 7.13.12 Procedural Steps

#### Day 1

#### Macroscopic Examination

- Examine the fluid macroscopically for colour, turbidity, or presence of blood.

#### Culture

- Transfer part of the fluid into another sterile plain tube.
- Centrifuge one aliquot of the fluid at 3000rpm for 5 minutes and tip off the supernatant.
- Inoculate part of the sediment heavily onto blood agar plates, chocolate agar, MacConkey agar, and sabouraud's agar.
- Use part of the sediment to make a smear for gram stain and ZN stain.
- Incubate the MAC agar plate aerobically at 37°C for 24 hrs.
- Incubate BA plate and CHOC plate at 37°C in 5% CO<sub>2</sub> for 24 hrs.
- Incubate sabouraud's agar aerobically at 37°C for up to 14 days.

#### Gram stain

- Prepare a smear from the sediment of given body fluid in tube 1.
- Allow to air dry.

- c. Fix the smear with methanol or with heat.
- d. Gram stains the smear.
- e. Examine for microorganisms using x100 objective and report findings.
- f. Ziehl-Neelsen Stain
- g. Make a smear as described for gram stain and stain with ZN stain or Auramine O stain.
- h. Examine the stained smear for Acid Fast Bacilli (AFB).

### **Day 2**

- Examine plates for possible pathogens and Perform appropriate identification biochemical tests (Refer to Identification flow Chart/Biochemical tests for microorganisms)
- Perform susceptibility tests on all pure growths not deemed as contaminants using.
- Re-incubate all culture plates with no growth for 24 hrs under appropriate conditions.

### **Day 3**

- Read the biochemical tests and identify the organism and report findings (Refer to Identification flow Chart/Biochemical tests for microorganisms)
- Record the identification biochemical tests.
- Report susceptibility results

#### **7.13.13 Biological Reference Intervals**

Not Applicable

#### **7.13.14 Interpretation and Reporting of Results**

- Blood-stained fluids may indicate traumatic puncture.
- A turbid fluid is indicative of an infection.
- If the fluid contains a predominance of polymorphs is indicative of acute bacterial infection.
- A predominance of lymphocytes in fluids is indicative of viral, TB or fungal infection.
- Report the Gram smear result along with the culture results

#### **7.13.15 Limitation of the Procedure and Sources of Errors**

If aseptic procedures are not strictly adhered to in collection and processing of Samples, cultures may yield contaminants.

Administration of antimicrobial agents before Sample collection may affect the recovery of microorganisms.

The technique described above will not isolate viruses or fastidious organisms such as *Mycobacterium*, *Treponema* and *Leptospira*.

Delay in transportation and subsequent processing of fluid Samples after collection may affect the recovery of microorganisms.

#### **7.13.16 Performance Characteristics**

Not applicable

**7.13.17      *Supporting Documents***

Laboratory quality policy manual

Laboratory safety policy manual

Laboratory sample collection manual

**7.13.18      *References***

Clinical Microbiology Procedures Handbook, 3<sup>rd</sup> edition, 2010. ASM Press, Washington. DC.

Manual of Clinical Microbiology, 8<sup>th</sup> edition, 2003. ASM Press, Washington. DC

Baker, F and Silvertone, R.E (1985). Introduction to Medical Laboratory Technology (6<sup>th</sup> edition). Butterworths, London

Baker, F.J (1980) Medical Microbiological Techniques. Butterworths, London.

Basic Laboratory Procedure in clinical bacteriology 2<sup>nd</sup> Edition.

Cheesbrough, M (1987). *Medical Laboratory Manual for Tropical Countries* (Vol. II). Butterworth-Heinemann, London.

## 7.14 EXAMINATION OF WOUND (PUS AND ABSCESS)

### 7.14.1 Purpose

This procedure provides instructions for processing pus, wound, ear, nose, throat and eye swabs for culture and sensitivity.

### 7.14.2 Scope

The procedure is used in the Bacteriology section whenever ear, nose, throat and eye swabs are received.

### 7.14.3 Responsibility

Qualified and competent Medical Laboratory practitioners are responsible for implementing this test procedure.

The Head Microbiology is responsible for ensuring the effective implementation and maintenance of this procedure.

### 7.14.4 Principle

Lysozyme enzyme that constantly bathes the eye renders the eye virtually a sterile site though exposed to the external environment. The presence of microorganisms in the eye sample is indicative of an infection and may be demonstrated by microscopy and/or culture examination. In clinically indicated pus, wound, ear, nose or throat infections, responsible microorganisms often occur in predominant numbers and may be demonstrate by microscopy and/or culture examination.

### 7.14.5 Sample Requirements

Pus, Wound, Ear, nose, throat, eye and surface swabs.

Transport media – Amies transport media.

### 7.14.6 Equipment

Aerobic Incubator, Biosafety cabinet, Microscope, Refrigerator, Anaerobic jar 2-5% CO<sub>2</sub>

### 7.14.7 Materials

Reagent	Consumables
<ul style="list-style-type: none"><li>• Antimicrobial susceptibility discs</li><li>• Biochemical reagents</li><li>• Control organisms</li><li>• Glass slides</li><li>• Glass cover slips</li><li>• Gram and ZN stain reagents</li><li>• MCA, SDA and Chocolate agar</li></ul>	<ul style="list-style-type: none"><li>• Petri dishes (Sterile disposable)</li><li>• Physiological saline</li><li>• Sterile swabs, disposable gloves, match box, forceps, marker pen, spirit</li><li>• Wire loop</li></ul>

### 7.14.8 Storage and Stability

When delay is anticipated store sample to 2 - 8°C

### 7.14.9 Safety

- Decontaminate working surfaces as recommended by IPC Guidelines
- Adhere to safety precautions as stated in the Safety manual
- All personal protective equipment (PPE) must be worn when performing this procedure.
- All samples must be regarded as potentially infectious.
- All spills should be wiped thoroughly using 1% sodium hypochlorite solution.

#### **7.14.10 Calibration**

Not Applicable

#### **7.14.11 Quality Control**

Quality control of media and reagents is done as per Procedure for media and reagents preparation

#### **7.14.12 Procedural Steps**

##### **Day 1. Macroscopy appearance**

Look colour, volume, smell and consistent of samples and report on the worksheet

##### **Microscopy examination**

Perform gram stains on pus, wound, ear, eye, nose and per nasal samples.

Gram stains are not necessary on mouth (except in necrotising ulcerative gingivitis [Vincent's infection]), nasopharynx and throat samples.

##### **Culture**

- Inoculate the sample onto 2 Blood agar plates, Chocolate, Sabouraud Dextrose and MacConkey agar
- Incubate one of the Blood agar plate as well as MacConkey agar plate aerobically at 37°C for 18 – 24 hours.
- Incubate another Blood agar plate and Chocolate agar plate at 37°C in 5% CO<sub>2</sub> for 18 – 24 hours
- Incubate Sabouraud Dextrose agar at 35 °C

##### **Day 2. Reading the culture plates**

Examine aerobic cultures for possible pathogens (Refer to **Identification Flow Chart/Biochemical tests for microorganisms**). Record observations on **Microbiology culture worksheet**

Set up appropriate biochemical tests accordingly

Perform susceptibility tests using the **Procedure for antibiotic susceptibility testing**

Re-incubate all culture plates with no growth for another 18 – 24 hours.

##### **Day 3. Reading the biochemical tests**

- Read the biochemical tests (**Refer to Identification Flow Chart/Biochemical tests for microorganisms**)
- Record the identification biochemical tests on **Microbiology culture worksheet**
- Read the susceptibility plates and record results on **Microbiology culture worksheet**

- iv. Examine the re-incubated aerobic and anaerobic plates for possible pathogens and set up appropriate biochemical tests.
- v. Perform susceptibility tests following ***Procedure for antibiotic susceptibility testing, and*** read the next day.

#### **7.14.13 Biological Reference Intervals**

Not Applicable

#### **7.14.14 Interpretation and Reporting of Results**

- i. Report the pathogen isolated and the antimicrobial susceptibility pattern
- ii. Record the results on Microbiology culture worksheet
- iii. If there is no growth in culture media, report as NO BACTERIAL GROWTH
- iv. If there is growth of coliform /normal flora in culture media, report as NO PATHOGEN ISOLATED / Normal floral isolated
- v. If there is a growth of pathogen in culture media perform Biochemical test to identify the pathogen and perform Antimicrobial susceptibility test
- vi. In case of eye samples, report all negative cultures as "No growth".
- vii. The eye is normally a sterile site; hence the isolation of micro-organisms from eye samples is indicative of an infection.
- viii. In gram stain smears from gingival ulcers the presence of gram negative spirochaetes and fusiform bacilli is indicative of necrotic ulcerative gingivitis.
- ix. In the ear, nose, pus, wound and throat samples hence there is isolation of pathogenic microorganism indicate of an infection of respective areas
- x. For nose, pernasal, mouth, nasopharynx or throat sample cultures where no pathogen is isolated report as "Normal flora Isolated."NO pathogen isolated

#### **7.14.15 Limitation of the Procedure and Sources of Errors**

Administration of antimicrobial agents before sample collection may affect the recovery of microorganisms in blood culture media.

Delay in transportation and processing of samples may affect the recovery of microorganisms in blood culture media.

#### **7.14.16 Performance Characteristics**

Not Applicable

#### **7.14.17 Supporting Documents**

- Laboratory quality policy manual, Laboratory safety policy manual

#### **7.14.18 References**

Baker, F and Silvertone, R.E (1985). Introduction to Medical Laboratory Technology (6th edition). Butterworths, London

Baker, F.J (1980) Medical Microbiological Techniques. Butterworths, London.

## **7.15 SPUTUM CULTURE FOR PATHOGENS OTHER THAN MTB CAUSING AGENTS**

### **7.15.1 Purpose**

This procedure provides instructions for culturing sputum samples in order to isolate organism known to cause bacterial respiratory infections.

### **7.15.2 Scope**

This procedure is used to help staff to identify bacteria or other type of germs causing infection in the lung or airway in the Laboratory

### **7.15.3 Responsibility**

Competent Health Laboratory Practitioners are responsible for implementing this test procedure.

The Head Microbiology is responsible for ensuring the effective implementation and maintenance of this procedure.

### **7.15.4 Principle**

Microorganisms and/or other particles entering the lower respiratory tract (LRT) are trapped by mucous and cilia lining the trachea and bronchioles and swept out as sputum. This renders the LRT virtually sterile. Infection of the LRT induces inflammatory reactions that lead to increased sputum and WBC collection in the respiratory tract. Microorganisms responsible for the LRT infection (LRTI) often occur in predominant numbers in the presence of WBC and may be demonstrated by microscopy and/or culture examination of sputum.

### **7.15.5 Sample Requirements**

collect sputum in a disposable, wide mouthed, screw-capped plastic container of about 100 ml capacity.

### **7.15.6 Equipment**

35-37°C Incubator, Carbon dioxide incubator, Microscope, Hot air oven, refrigerator

### **7.15.7 Materials**

<b>Reagent</b>	<b>Consumables</b>
<ul style="list-style-type: none"><li>• Blood Agar, Chocolate Agar, MacConkey agar</li><li>• Saboraud Dextrose Agar (in immune compromised patients)</li><li>• Gram Stain</li><li>• ZN Stain</li><li>• Biochemical reagent</li></ul>	<ul style="list-style-type: none"><li>• Slides</li><li>• Applicator sticks Standard wire loop (e.g. 1 µl [0.001ml])</li><li>• Spirit lamp/Cooking gas</li><li>• Match box</li><li>• Gloves</li></ul>

### **7.15.8 Storage and Stability**

When delay anticipated store sputum at 2 – 8°C

### **7.15.9 Safety**



- i. Decontaminate working surfaces as recommended by IPC Guidelines
- ii. Adhere to safety precautions as stated in the Safety manual.
- iii. All personal protective equipment (PPE) must be worn when performing this procedure.
- iv. All samples must be regarded as potentially infectious.
- v. Avoid any contact between hands and eyes and nose during sample collection and testing.
- vi. All spills should be wiped thoroughly using 1% sodium hypochlorite solution.

#### **7.15.10 Calibration**

Not applicable

#### **7.15.11 Quality Control**

Perform Quality control of media and reagents when new lot prepared

#### **7.15.12 Procedural Steps**

- i. Macroscopic appearance: Describe the sample: purulent, mucopurulent, mucoid, salivary, contains blood
- ii. Prepare a thin film with broken applicator stick and do Gram Stain and look for pus cells and bacteria.
- iii. Do ZN Stain and look for Acid Fast Bacilli
- iv. Culture sample on BA, CA, MCA, SDA (incubate CA in CO<sub>2</sub>), other media incubate at 35 for 24 hrs, aerobically. If Optochin discs are available, place one on to the BA within the area of the Second spread. This will help to identify s.pneumoniae.
- v. On BA and CA look for s.pneumoniae, H.influenzae, S.aureus, S. pyogenes, M.catarrhalis.
- vi. On SDA: yeast cells
- vii. On MCA: observe for Klebsiella pneumoniae, Aeruginosa, Proteus,
- viii. VI. Identify the organisms as required. Set Susceptibility if growth of a pathogen is significant.
- ix. **Reading Biochemical tests**
- x. Read the biochemical tests and identify the organism. and report the identified organism(s).
- xi. Record the identification biochemical tests on Microbiology culture worksheet
- xii. Read the susceptibility plates as recommended and report.

#### **7.15.13 Biological Reference Intervals**

Not applicable

#### **7.15.14 Interpretation and Reporting of Results**

Report Culture as:

*Colonial morphology*

Report cultures without growth as 'No bacteria growth'

Report cultures with growth name of pathogenic organism

Report culture with normal flora as Normal flora isolated

NOTE: Culture: The interpretation of sputum isolates can be challenging because there is a mixed growth of bacteria.

Look for SIGNIFICANT growth of:

*Streptococcus pneumoniae* sensitive to Optochin

*Haemophilus influenzae*, *Staph aureus*, *Klebsiella pneumoniae*, *Pseudomonas aeruginosa*, *Moraxella catarrhalis*, *Proteus spp*, *Streptococcus pyogenes*, *Candida albicans*

#### **7.15.15      *Limitation of the Procedure and Sources of Errors***

If no floccules of pus cells seen {such as in grey mucoid sputum samples} the gram stain smear may show only the presence of large, rather square, squamous epithelial cells, frequently covered with masses of adherent bacteria. This indicates that the sample consists of mainly mouth or throat secretions, culture should not be carried out as it is not relevant and usually high misleading.

An accepted guideline is to reject any sample that contains fewer than 10 polymorph nuclear neutrophils per epithelial cells

#### **7.15.16      *Performance Characteristics***

Refer to method verification report

#### **7.15.17      *Supporting Documents***

Sample collection manual

#### **7.15.18      *References***

Basic Laboratory Procedure in clinical bacteriology 2<sup>nd</sup> Edition.

## **7.16 PROCESSING AND CULTURING OF SAMPLES FOR FUNGAL INFECTION**

### **7.16.1 Purpose**

The purpose of this procedure is to provide guidance on processing and culturing of samples for fungal infections

### **7.16.2 Scope**

It applies in processing and culturing of fungal infections

### **7.16.3 Responsibility**

Trained and competent medical laboratory practitioners are responsible in implementing this procedure

### **7.16.4 Principle**

The principle of culturing samples for fungal infection is to provide the fungus with the optimal conditions for growth in a laboratory setting. This allows the fungus to be identified and antifungal susceptibility testing to be performed.

### **7.16.5 Sample Requirements**

Samples submitted for fungus cultures may come from either sterile or non-sterile body sites.

Normally sterile Samples include cerebrospinal fluid (CSF), other sterile body fluids such as blood, bone marrow, pleural fluid, peritoneal fluid, joint fluid; tissue biopsies and fine needle aspirates from body sites such as the lung, liver, brain, lymph nodes. Non-sterile Samples include respiratory samples such as sputum, tracheal aspirate, Broncho alveolar lavage fluids; skin, nails and hair samples; midstream urine; superficial wound swabs; throat, mouth, ear material; and vaginal or cervical material.

### **7.16.6 Equipment**

Incubator and microscope

### **7.16.7 Materials**

Culture Media

Two general types of culture media are essential to ensure the primary recovery of all clinically significant fungi from clinical Samples. One medium should be nonselective that will permit the growth of virtually all fungal species. A second medium, more selective for the recovery of fungi, should also be used. Chloramphenicol, gentamicin, and cycloheximide may be added to the medium to inhibit the growth of bacteria or saprobic fungi that may be found in nonsterile Samples.

The following fungal media are used in this laboratory for primary culture of Samples:

SABHI: Sabouraud Brain Heart Infusion agar slants

SABHI + CC: SABHI with Chloramphenicol and Cycloheximide agar slants

SAB: Sabouraud Dextrose Agar plates

SAB + CC: SAB containing Chloramphenicol and Cycloheximide plates.

Plated media must be thick to resist dehydration during prolonged incubation. For a heavy fill, dispense 40 ml of prepared media in sterile 100 mm petri dishes.

Tubed media provide maximum resistance to dehydration and contamination. Dispense prepared media in 25 x 150 mm screw-cap tubes.

Sterile disposable scalpel, forceps, petri dishes, transfer pipettes, cotton swabs, inoculating loops, and calibrated inoculating loops (0.001ml for urines).

Oxygen-permeable sealing tape (Shrink seal or Petri Seal)

Lacto phenol cotton blue (LPCB) or lacto phenol aniline blue, normal saline solution (NSS), India ink, serum for germ tube, sterile water.

Fungal media and biochemical media: Sabouraud (SAB), Sabouraud with cycloheximide, potato dextrose agar (PDA), cornmeal agar, cornmeal-tween 80 agar, Dermatophyte Test Medium (DTM), urea slant, *Trichophyton* agars.

Commercially prepared identification system (e.g., API 20C)

Microscope slides, coverslip, petri dishes, dissecting needles, applicator sticks, cellophane tape, filter paper, scalpel, and bent glass rods.

#### **7.16.8 Storage and Stability**

Store media in 2 - 8°C

#### **7.16.9 Safety**

- a. Observe standard safety precautions when handling blood and other body fluids and tissues. Refer to laboratory Safety Manual.
- b. Process Samples inside the biologic safety cabinet observing biosafety level (BSL) 2 practices.
- c. Decontaminate work surfaces with 10% bleach after each batch of sample processing. Discard all used materials (e.g., swabs, pipettes, disposable forceps) in a bucket containing bleach.
- d. Seal each plate/tube with O<sub>2</sub> permeable tape (shrink seal or Petri-seal) to prevent exogenous contamination and to protect personnel from pathogenic molds.
- e. Observe general safety precautions. Refer to laboratory safety manual.
- f. In addition to the general safety precautions and microbiology laboratory safety guidelines, the following special safety precautions must also be observed when processing and handling fungal cultures:
  - i. ALWAYS perform manipulation of mold cultures inside a certified biological safety cabinet (Class II biological safety cabinet). Yeast cultures can be handled on the bench in the same manner that bacterial cultures are routinely handled.
  - ii. NEVER open a culture plate on the bench when mold colonies are growing.
  - iii. NEVER sniff a fungal culture to determine whether it has an odor.
  - iv. ALWAYS seal plates for fungus cultures with oxygen-permeable tape to prevent dehydration and avoid unintentional opening.
  - v. Tubed slants of media are safer to handle than plates.

- vi. Petri plates should NEVER be used if *Coccidioides immitis* is suspected or if a culture is to be mailed.
- vii. When processing mold colonies, care must be taken not to spatter infectious materials by careless flaming of needles or loops. A microcinerator or disposable loops and needles may be used to avoid this hazard.
- viii. A wet preparation on lactophenol cotton blue should be made of all molds, before setting up a slide culture; do not set-up slide cultures on dimorphic mold isolates that may be *Histoplasma capsulatum*, *Blastomyces dermatitidis*, *Coccidioides immitis*, or *Paracoccidioides brasiliensis*.
- ix. All contaminated materials such as loops, needles, and slide cultures must be disposed of in sharps containers containing 10% bleach.
- x. Seal plates of processed mold cultures with tape before discarding them into the red-lined garbage containers.
- xi. All contaminated materials must be autoclaved before being discarded.

**7.16.10 Calibration**

Not Applicable

**7.16.11 Quality Control**

Check that the patient name and identifiers on the sample match that on the accompanying requisition. Check that sample meets all criteria for acceptability.

Ensure that all media and reagents have passed the required Quality control and are used within their expiry date.

**7.16.12 Procedural Steps**

**Media Selection:**

- a. Samples from normally sterile body sites: Inoculate a set of SABHI and SABHI + CC slants.
- b. Samples from normally contaminated body sites (respiratory, wound, abscess): Inoculate a set of SABHI and SABHI + CC plates.
- c. Skin, nails, hair: Inoculate one SAB and one SAB + CC plate.
- d. If *Malassezia furfur* is suspected, inoculate a second set of plates swabbed with 1-2 ml of olive oil.
- e. Urine, vagina, ear, throat and mouth for yeasts: Inoculate one SAB plate.

**Sample Preparation and Inoculation:**

- i. Inoculate media with the maximum amount of sample (at least 0.5 ml), but retain some for preparation of smears for direct microscopic examination.
- ii. Blood and bone marrow: Load bottles into the blood culture instrument. Follow instrument protocol for length of incubation.
  - CSF and other body fluids:
- iii. Centrifuge quantities of > 2 ml for ten minutes at 2000 x g.
- iv. The supernatant fluid should not be decanted.

- v. With a sterile pipette, remove the sediment and use to inoculate the medium and prepare smears for microscopic examination.
- vi. Any remaining sediment is resuspended, and the medium is re-inoculated with large amounts of the whole Samples. If less than 2 ml of sample is received, it should be inoculated directly onto the media.

**Exudates, pus, and drainage:**

- i. Samples should be carefully examined with a dissecting microscope for the presence of granules.
- ii. If none are present, the material can be inoculated directly onto media.
- iii. If granules are present, the color is noted, and then a portion of the sample is teased apart gently, crushed between two glass slides, and examined microscopically;
- iv. The remainder is washed several times in sterile distilled water,
- v. Crush the reminder with a sterile glass rod or similar material, and
- vi. Inoculate onto appropriate media.

**Respiratory Samples:**

- a. Inoculate Samples as for bacterial culture.
- b. Flecks containing pus, blood, or caseous materials should be sought and used in culture and smears.

**Tissues:**

- i. Place tissue sample on a sterile petri dish.
- ii. Add a few drops of sterile saline and cut tissues into 1-mm cubes with sterile scissor or scalpel blade.
- iii. Place several pieces directly onto the agar, submerging them slightly beneath the surface using sterile scalpel or disposable forceps. It is acceptable to slightly cut the surface of the culture medium.
  - When *H. capsulatum* is suspected, grinding with a mortar and pestle is essential in order to release the intracellular yeasts and enable their growth on the culture medium.
  - A small amount of sterile broth or distilled water can be added to smooth the process of grinding.
- iv. Cut hair samples into 1 cm portions with sterile scissors and place the hair portions directly onto the agar, submerging them slightly beneath the surface using sterile scalpel or disposable forceps.
- v. Cut nail samples into small pieces and place the portions directly onto the agar, submerging them slightly beneath the surface.

**Swabs:**

- i. Inoculate directly onto appropriate media.

**Urine:**

- ii. Centrifuge urine at 2,000 x g for ten minutes, the supernatant is decanted,

- iii. Place approximately 0.5 ml of the sample on each medium to be used.

### **Corneal scrapings**

- i. Transfer corneal scrapings from the surgical instrument to the fungal plates or blood agar plate by making a series of “C” or “X” shaped cuts on the medium. This is done by the ophthalmologist.
- ii. Maintain inoculated plates at room temperature before transportation to the laboratory.
- iv. Upon receipt in the laboratory, seal all inoculated plates with gas-permeable tape or shrink-seal before removing them from biosafety cabinet.

### **Incubation conditions**

- i. Incubate inoculated plates/tubes at  $30 \pm 2^{\circ}\text{C}$  for four weeks. If a  $30^{\circ}\text{C}$  incubator is not available, cultures may be incubated at room temperature (approximately  $25^{\circ}\text{C}$ )
- ii. Incubate cultures suspected of containing thermally dimorphic systemic fungi for eight weeks before reporting as negative.
- iii. Incubate cultures for yeasts in oral thrush, vaginitis, or urine for five days.
- iv. Incubate tubed media in a slanted position for 24 hours after inoculation in order for the inoculum to remain dispersed (rather than accumulating at the bottom of the slant). A metal slanting rack designed for Acid Fast Bacilli cultures may be used for this purpose. The tubes can be stood vertically for subsequent incubation. The screw caps must be kept partially loosened to ensure proper atmospheric conditions.
- v. A pan of water should be placed in the incubator to prevent dehydration of the plates.

### **Identification of fungi**

- i. The extent to which yeast needs to be identified depends primarily on the body site from which it is isolated and the clinical relevancy of full identification.
- ii. In general, the isolation of yeasts from sterile body sites is suggestive of infection; full identification should be performed.
- iii. The presence of a capsule does not automatically ensure that the yeast is *Cryptococcus neoformans*, as other cryptococci, *Rhodotorula* spp., and rare *Candida* spp. produce capsule-like structures. In practice, any nonpigmented, round, encapsulated yeast recovered from CSF should be considered *C. neoformans* until proven otherwise.
- iv. The presence of yeasts in sputum has little significance, as the respiratory tract is frequently colonized by *Candida* species in patients receiving ventilatory support. *C. neoformans* and *C. gattii* are typically the only yeasts of concern in such samples. *Cryptococcus* species are ruled out using a rapid urease test, report result as “Yeast, not *Cryptococcus*.”

- v. When appropriate, screening any sample for only *C. albicans* on nonchromogenic agar can be rapidly accomplished by the germ tube test or by simply examining the colonies on blood agar and chocolate agar for mycelial projections, commonly called “feet.”.
- vi. Clinical characteristics along with direct microscopic examination of vaginal secretions are better than culture for the diagnosis of vaginal candidiasis. *Candida* spp. are part of the normal vaginal biota, and their presence alone is not significant. On rare occasions, vaginal lesions can be seen with histoplasmosis or paracoccidioidomycosis. These lesions do not resemble those seen with *Candida* spp. If these are suspected, a full fungal culture and microscopic smear should be performed.
- vii. In the event that there is insufficient material for both microscopy and culture, all of the samples should be used for culture since this is the more sensitive procedure for detection of fungi.
- viii. The sputum quality grading system is not applicable to samples submitted for fungal cultures. The presence of large numbers of squamous cells (>25/lpf) is not a criterion for rejection of sputum for fungal culture in that pathogenic fungi can be recovered in the face of contamination, particularly when selective fungal media is used.
  - **If the colony is mucoid.**
    - i. Determination should immediately be made as to whether the isolate may be *C. neoformans/gattii*; proceed as follows:
      - a. Prepare a wet mount of the colony in NSS; *C. neoformans* and *C. gattii* appear as round, dark-walled cells of various sizes.
      - b. Add F to the wet prep to demonstrate capsules (may be small), if present.
      - c. Inoculate a urease slant heavily at the top of the slant (that area will turn positive more rapidly than the rest of the agar).
    - ii. If any of the tests listed above suggest *Cryptococcus*, the isolate should be
      - d. Inoculated to Cornmeal Tween 80.
      - e. From the Cornmeal agar, test for phenoloxidase with the caffeic acid disk test; the caffeic disk test can be performed directly from the primary isolation medium, but a false negative may result if the medium contains glucose.
    - iii. The first isolate of *Cryptococcus* from a patient should be confirmed with a commercial yeast identification system (e.g., API 20C). If the isolate is shown to be *C. neoformans* or *C. gattii*, it is reasonable to do only the caffeic disk test on subsequent isolates.
      - i. If the colony is not mucoid
      - ii. Prepare a wet mount of the colony in NSS. Note size and shape of the yeast, and presence or absence of pseudohyphae, true hyphae, or arthroconidia. Record observations on the culture worksheet.
      - iii. Perform a germ tube test.



- iv. If the germ tube test is negative and the colony is small and relatively slow-growing, and the wet prep shows small, oval cells, perform the Rapid Assimilation of Trehalose (RAT) test for identification of *Candida glabrata*.
  - v. If the isolate is not *C. albicans* or *C. glabrata* and further identification is desired, use a pure culture to perform biochemical tests for yeast identification (e.g., API 20C).
  - vi. Using the Dalmau method, inoculate a plate of Cornmeal-Tween 80 agar; this should accompany the commercial biochemical identification systems. Observe for yeast morphology under the microscope.
  - vii. Subsequent tests may be required if an acceptable identification is not obtained such as temperature studies, inhibition by cycloheximide, urease activity, etc.
- c. Examine cultures for yeast (urine, throat, vaginal) daily for five days.

#### **7.16.13 Biological Reference Intervals**

Not Applicable

#### **7.16.14 Interpretation and Reporting of Results**

##### **Macroscopic Examination of Cultures:**

Examine for growth 3x during the first week (Monday, Wednesday, and Friday) and weekly thereafter (every Wednesday). Rapid growers will appear by the first or second time the cultures are examined whereas slowly growing fungi may not be evident for two to three weeks or longer.

When mature growth develops, note the texture and surface colour of the colony. The colour of the reverse (underside) must also be recorded, along with any pigment that diffuses into the medium. Record observations on the worksheet.

Also, observe whether the fungus grows on the medium containing cycloheximide. Subculture any yeast, mold or actinomycetes that grow on primary media to ensure the viability and isolation of the organism. When more than one fungus is seen on the primary culture, a subculture is necessary for isolation. Seal plates with shrink seal. Hold cultures for four weeks even though some fungi may have been isolated.

##### **Microscopic Examination of Growth**

Examine a fungus microscopically when the culture first begins to grow and form conidia or spores and again a few days later. In many instances, the manner of conidiation or sporulation, which is so important to identification, is obscured in old cultures. PDA often promotes sporulation better than does SAB.

*Caution! Manipulation of mold must ALWAYS be carried out in a Class II BSC.*

Tease mount.

Place a drop of LPCB on a clean glass slide. With a sterile needle, remove a small portion of the colony from the agar surface and place it in the drop of LPCB. With two dissecting needles, gently tease apart the mycelial mass of the colony on the slide, cover with a coverslip, and observe under the microscope with low power and high dry

magnifications. This method does not always preserve the original position and structure of the conidia, spores, and other characterizing elements.

Cellophane tape mount.

Loop back on itself a 1.5 inch strip of clear tape, sticky side out, and hold the tip of the loop securely with some forceps. Press the lower, sticky side very firmly to the surface of the fungal colony, and then pull the tape gently away. Aerial hyphae will adhere to the tape. Then, with the tape strip opened up, place it on a small drop of LPCB on a glass slide so that the entire sticky side adheres to the slide, and examine it under the microscope. This method is usually successful in retaining the original positions of the characteristic fungus structures but has the drawback of requiring the fungus to be grown on plated medium.

*Note:* The preparation may be covered with a coverslip before microscopic examination.

Slide culture. The best method for preserving and observing the actual structure of a fungus is the slide culture. It is not a rapid technique, but it is unsurpassed as a routine means of studying the fine points of the microscopic morphology of fungi. Important! Always do a tease or wet mount before a slide culture; organisms suspected of *Histoplasma*, *Blastomyces*, or *Coccidioides* spp. or *Cladophialophora bantiana* should NOT be set-up on slide culture.

Positive Cultures: Report identity of yeast or mold isolate.

Issue prelim report once mold growth is observed:

Example: "Fungus isolated after \_\_\_ days of incubation."

Negative Cultures: Report as "No Fungus Isolated after 4 weeks of incubation."

It is not necessary to report the quantity of growth on culture; however, this information should be recorded on the culture worksheet.

#### **7.16.15      *Limitation of the Procedure and Sources of Errors***

False positive is due to contamination

#### **7.16.16      *Performance Characteristics***

Refer to method verification report

#### **7.16.17      *Supporting Documents***

Sample collection manual

#### **7.16.18      *References***

Lynne S. Garcia, Henry D. Isenberg. Clinical Microbiology Procedures Handbook. 3<sup>rd</sup> edition. American Society for Microbiology. Washington DC, USA. 2010.

Davise H. Larone. Medically Important Fungi. A Guide to Identification. 5<sup>th</sup> edition. American Society for Microbiology. Washington DC, USA. 2011

## 7.17 CATALASE TEST

### 7.17.1 Purpose

This procedure provides instructions for performing catalase test.

### 7.17.2 Scope

This procedure is to be used for performing Catalase test in the Laboratory

### 7.17.3 Responsibility

The section heads and technical staffs are responsible for implementing this procedure.

### 7.17.4 Principle

Bacteria that synthesize the enzyme catalase hydrolyze hydrogen peroxide into water and gaseous oxygen, which results in the liberation of gas bubbles. The test is useful in initial characterization of most bacteria. The catalase test separates staphylococci (positive) from streptococci and enterococci (negative). For spore forming organisms, *Bacillus spp.* are catalase positive, and *Clostridium spp.* are catalase negative. *Neisseria gonorrhoeae* produces an enhanced elaboration of bubbles not seen with other members of the genus due to superoxol. The superoxol is a simple test that uses 30% hydrogen peroxide (H<sub>2</sub>O<sub>2</sub>) as a reagent. Reactions of superoxol with *N. gonorrhoeae* are typically “explosive” (4+, very strong), compared with weaker (2+) reactions with most non-gonococcal *Neisseria species*, and a negative reaction with *K. denitrificans*. In contrast, the catalase test is performed with 3% hydrogen peroxide and yields much weaker results.

(This method detects the presence of the catalase enzyme, which hydrolyses H<sub>2</sub>O<sub>2</sub> to produce H<sub>2</sub>O and O<sub>2</sub>.)

### 7.17.5 Sample Requirements

- The young bacterial colonies of 18 to 24 hours old from agar media.
- Preferably from Chocolate Agar (CA).
- If necessary Blood Agar Plate (BAP) may also be used with much attention.

### 7.17.6 Equipment

Not applicable

### 7.17.7 Materials

Reagent	Consumables
<ul style="list-style-type: none"><li>• Catalase reagent: 3% Hydrogen Peroxide (H<sub>2</sub>O<sub>2</sub>)</li><li>• Dilute 30% H<sub>2</sub>O<sub>2</sub>, 1:10 in deionized water, store at 2 - 8 oC</li><li>• Reagent may be stored for up to 6 months.</li></ul>	<ul style="list-style-type: none"><li>• Personal protective gears</li><li>• Plastic disposable/ wire loop</li><li>• Gauze</li><li>• Clean Glass slides</li><li>• Applicator stick</li><li>• Diamond pencil or Grease pencil</li></ul>

<ul style="list-style-type: none"> <li>• Superoxol reagent for Neisseria: 30% Hydrogen Peroxide (H<sub>2</sub>O<sub>2</sub>), store at 2-8 °C.</li> </ul>	<ul style="list-style-type: none"> <li>• Small plastic sheet or gloves</li> </ul>
---	---

#### **7.17.8 Storage and Stability**

- Store Media powder according to manufacturer's specifications.
- Refrigerate prepared culture media on 2-8°C

#### **7.17.9 Safety**

- a) Decontaminate working surfaces as recommended by IPC Guidelines
- b) Adhere to safety precautions as stated in the Safety manual
- c) All personal protective equipment (PPE) must be worn when performing this procedure.
- d) All samples must be regarded as potentially infectious.
- e) Refer to National infection prevention and control Guidelines for health waste management and safety practice.
- f) Do not use kit beyond the expiration date which appears on the package label or device in a damaged pouch.
- g) All spills should be wiped thoroughly using 0.5% sodium hypochlorite solution.

#### **7.17.10 Calibration**

Not applicable

#### **7.17.11 Quality Control**

- Known positive and negative control organisms each time this procedure is performed.
- Check new batches of stain and reagents for correct reactions using colonies with known positive and negative organisms.
- Discard the slides and make a new batch if satisfactory results are not obtained.

#### **7.17.12 Procedure Steps**

- a) Touch the centre of a well-isolated colony; transfer to a clean glass slide.
- b) Be sure colony is visible to the naked eye on slide.
- c) If colony is from BAP, use care not to pick up blood.
- d) Place 1 drop of hydrogen peroxide reagent on slide and observe immediately for effervescence.
- e) Do not reverse the order of adding the reagent to the colony; false negative result can occur.
- f) Do not mix reagent and the colony.
- g) Use a magnifying lens to observe bubbling if necessary.
- h) Hold over dark background to enhance bubbles.
- i) Discard slide into sharps container

#### **7.17.13 Biological Reference Interval**

Not applicable

**Critical Value**

Not applicable

#### **7.17.14 Interpretation and Reporting of Results**

- Positive: shows immediate appearance of bubbles.
- Negative: shows no bubbles or a few bubbles after 20 seconds.

#### **7.17.15 Limitation of the Procedure and Sources of Error**

- a) Caution: 30% Hydrogen Peroxide (H<sub>2</sub>O<sub>2</sub>) is extremely caustic to skin. If contact occurs, wash immediately with 70% ethyl alcohol not water.
- b) 30% Hydrogen Peroxide (H<sub>2</sub>O<sub>2</sub>) reagent can be used for all tests, but it is more hazardous.
- c) Red blood cells contain catalase. To avoid false positive results, do not pick up blood agar with colony. If colony does not easily pick up or grow well, repeat the test from CHOC, which does not interfere with the assay.
- d) Selecting colonies with some metal bacteriological loop materials will yield false positive results; platinum loops do not yield false positive results.
- e) For *Neisseria spp*: record as Superoxol positive or Superoxol negative.
- f) For other bacteria: record as Catalase test positive or Catalase test negative
- g) Do not test colonies that are older than 24 hours because the enzyme is present in viable cultures only. Older cultures may give false negative results

#### **7.17.16 Performance Characteristics**

Refer manufacturer performance characteristics compares to laboratory method verification report

#### **7.17.17 Supporting Documents**

- Laboratory quality policy manual
- Laboratory safety policy manual
- Laboratory sample collection manual

#### **7.17.18 References**

- a) Clinical Microbiology Procedures Handbook. American Society for Microbiology. Washington D.C., USA, 2<sup>nd</sup> edition, 2007.
- b) Monica cheesbrough (2005). District Laboratory Practice in Tropical countries. Cambridge University Press, New York, USA, 2<sup>nd</sup> edition, 2005.
- c) WHO, (2003). Manual of basic techniques for a health laboratory. Geneva. 2<sup>nd</sup> edition, 2003.
- d) Manual of Clinical Microbiology. American Society for Microbiology (ASM), Washington D.C., USA. 9<sup>th</sup> edition, 2007.
- e) Manual for the Laboratory Identification and Antimicrobial Susceptibility Testing of Bacterial Pathogens of Public Health Importance in the Developing World. U.S. Centers for Disease Control and Prevention (CDC), Atlanta, Georgia, U.S.A, and World Health Organization (WHO) Geneva Switzerland. 2003



## 7.18 COAGULASE TEST

### 7.18.1 Purpose

This procedure provides instructions for performing Coagulase test

### 7.18.2 Scope

This procedure is to be used for performing Coagulase test in the Laboratory

### 7.18.3 Responsibility

The section heads and technical staffs are responsible for implementing this procedure.

### 7.18.4 Principle

This test is used to differentiate *Staphylococcus aureus* from other *Staphylococcus* spp. by determining the ability of an isolate to clot plasma by producing coagulase enzyme.

Bacterial cell possesses two coagulase enzymes: free coagulase that is secreted extracellular and bound coagulase a cell walls associated protein. Free coagulase is detected in the tube coagulase test while bound coagulase is detected in slide coagulase test.

The bound coagulase is also known as clumping factor. It cross links the alpha and beta chains of fibrinogen in plasma to form fibrin clot that deposits on the cell wall. As a result, individual cocci stick to each other and clumping is observed.

### 7.18.5 Sample Requirements

Colonies (18-24 hours old) of Gram-positive cocci in clusters which are catalase positive, as part of the identification of *S. aureus*

### 7.18.6 Equipment

Not applicable

### 7.18.7 Materials

Reagent	Consumables
<ul style="list-style-type: none"><li>• Rabbit plasma/sheep in EDTA anticoagulated tube rehydrate according to manufacturer's instructions. Dispense 0.5 ml into sterile 12- by 75-mm tubes.</li><li>• Do not use plasma that appears turbid.</li><li>• Do NOT use human plasma for the test, as it is less sensitive and potentially infectious with human pathogenic viruses.</li><li>• Sterile deionised water.</li></ul>	<ul style="list-style-type: none"><li>• PPEs</li><li>• Plastic disposable/ wire loop</li><li>• Gauze</li><li>• Clean Glass slides</li><li>• Applicator stick</li><li>• Diamond pencil</li></ul>

- |   |  |
|---|--|
| <ul style="list-style-type: none"><li>• Positive and negative Control slides for gram positive &amp; negative organisms, respectively (if necessary).</li></ul> |  |
|---|--|

### **7.18.8 Storage and Stability**

Reconstituted reagent expires after one month if stored at -20°C or 5 days if stored at 2 to 8°C.

### **7.18.9 Safety**

- h) Decontaminate working surfaces as recommended by IPC Guidelines
- i) Adhere to safety precautions as stated in the Safety manual
- j) All personal protective equipment (PPE) must be worn when performing this procedure.
- k) All samples must be regarded as potentially infectious.
- l) Refer to National infection prevention and control Guidelines for health waste management and safety practice.
- m) Do not use kit beyond the expiration date which appears on the package label or device in a damaged pouch.
- n) All spills should be wiped thoroughly using 0.5% sodium hypochlorite solution.

### **7.18.10 Calibration**

Not applicable

### **7.18.11 Quality Control**

- Known positive and negative control organisms each time this procedure is performed.
- Check new batches of stain and reagents for correct reactions using colonies with known positive and negative organisms.
- Discard the slides and make a new batch if satisfactory results are not obtained.

### **7.18.12 Procedure Steps**

#### **Slide method**

- Using a sterile transfer pipette, place one very small drop (10 µl) of sterile deionized water on a slide.
- Emulsify several colonies of the test organisms into the water to obtain a smooth milk-colored suspension.

**Note:** If clumps occur and the organism does not suspend in the water, the slide test cannot be performed. Perform the tube test instead.

Using sterile loop, add rabbit plasma (1 to 3 µl). Mix and observe for clumping immediately, not to exceed 10 seconds. Record results.

Discard slide in a sharps container or in disinfectant bucket.

#### **Tube method:**

- Add 0.5ml of Rabbit's plasma into a test 12 x 75 mm tube.



- Inoculate the tube with several colonies of the test organism.
- Incubate at 35°C for up to 4 hours and observe hourly for clot formation. Do not agitate the tube; rather gently tip to observe the clot. If test is negative after 4 hours continue to incubate the test for 24 hours.
- After 24 hour incubation, observe for clot formation. Record results

#### **7.18.13 Biological Reference Intervals**

Not applicable

#### **Critical Value**

Not applicable

#### **7.18.14 Interpretation and Reporting of Results**

##### **Slide method**

- A positive slide test is reported as *S. aureus*; however, the test should be confirmed with a tube test from non hemolytic or only slightly hemolytic colonies from sterile sites such as blood, to separate *S. Aureus* from *S. lugdunensis* and *S. schleiferi*.
- All negative slide tests must be confirmed using the tube test.

##### **Tube method**

- Report as *Staphylococcus aureus* if the tube test is positive and the organism is coagulase positive and a Gram-positive coccus in clusters.
- For a negative tube test from coagulase-positive, Gram-positive cocci in clusters that have creamy, white colonies, report as “*Coagulase-negative Staphylococci*.”

#### **Results Interpretation**

##### **Slide method:**

*Positive:* presence of macroscopic clumping in 10 seconds or less.

*Negative:* no visible clumping.

##### **Tube method:**

Positive test - complete clot formation or any degree of clot formation

Negative test - lack of clot formation

#### **7.18.15 Limitation of the Procedure and Sources of Error**

- To avoid misidentifications, only perform this test on classic-looking, white to yellow, creamy, opaque, hemolytic colonies of gram-positive cocci in clusters that are coagulase positive.
- *Methicillin-resistant S. aureus* (MRSA) can be deficient in bound coagulase, which results in negative slide test.
- *S. lugdunensis* and *S. Schleiferi* produce slide coagulase, but the reaction is more efficient if human plasma is used rather than rabbit plasma. They can be separated from *S. aureus* by their strongly positive PYR reaction and from *S. intermedius* by a negative tube coagulase test.
- Coagulase testing cannot be performed from growth on mannitol salt agar

### **7.18.16 Performance Characteristics**

Refer manufacturer performance characteristics compares to laboratory method verification report

### **7.18.17 Supporting Documents**

- Laboratory quality policy manual
- Laboratory safety policy manual
- Laboratory sample collection manual

### **7.18.18 References**

- a) Clinical Microbiology Procedures Handbook. American Society for Microbiology. Washington D.C., USA, 2<sup>nd</sup> edition, 2007.
- b) Monica Cheesbrough (2005). District Laboratory Practice in Tropical countries. Cambridge University Press, New York, USA, 2<sup>nd</sup> edition, 2005.
- c) WHO, (2003). Manual of basic techniques for a health laboratory. Geneva. 2<sup>nd</sup> edition, 2003.
- d) Manual of Clinical Microbiology. American Society for Microbiology (ASM), Washington D.C., USA. 9<sup>th</sup> edition, 2007.

## 7.19 NOVOBIOCIN TEST

### 7.19.1 Purpose

This procedure provides instructions for performing Novobiocin test.

### 7.19.2 Scope

This procedure is to be used for performing Novobiocin test in the Laboratory

### 7.19.3 Responsibility

The section heads and technical staffs are responsible for implementing this procedure.

### 7.19.4 Principle

Novobiocin disks are recommended for the differentiation of coagulase-negative *Staphylococcus saprophyticus* based on novobiocin resistance. This method is based on the antibiotic disk diffusion test of Kirby and Bauer. *S. saprophyticus* has recently been recognized as a significant cause of urinary tract infections, especially in young women

### 7.19.5 Sample Requirements

Overnight growth of test isolate on Sheep Blood Agar. Test may be performed on isolates from primary culture plates. Organisms used for testing must be isolated and not mixed with normal flora.

### 7.19.6 Equipment

Incubator at  $35^{\circ} \pm 2^{\circ}\text{C}$ , and Biosafety cabinet

### 7.19.7 Materials

Reagent	Consumables
<ul style="list-style-type: none"><li>Novobiocin disks, 5 <math>\mu\text{g}</math> (round, 6mm paper disks).</li><li>Note: Store opened cartridge and desiccant inside a 15-ml conical tube with screw-cap to avoid deterioration due to excessive moisture.</li><li>Tube of sterile saline or tryptic soy broth (TSB), Mueller Hinton agar plate.</li></ul>	<ul style="list-style-type: none"><li>Personal protective gears</li><li>Sterile Plastic disposable/ wire loop.</li><li>Marker pen</li><li>Small plastic sheet or gloves</li><li>McFarland standard</li><li>Forceps</li><li>Ruler or caliper</li></ul>

### 7.19.8 Storage and Stability

Store Media powder and disks according to manufacturer's specifications.  
Refrigerate prepared culture media on  $2-8^{\circ}\text{C}$

### 7.19.9 Safety

- Decontaminate working surfaces as recommended by IPC Guidelines

- b) Temperatures for the room and refrigerator are recorded as recommended by IPC Guidelines.
- c) Adhere to safety precautions as stated in the Safety manual
- d) All personal protective equipment (PPE) must be worn when performing this procedure.
- e) All samples must be regarded as potentially infectious.
- f) Refer to National infection prevention and control Guidelines for health waste management and safety practice.
- g) Avoid any contact between hands and eyes and nose during sample collection and testing.
- h) Do not use kit beyond the expiration date which appears on the package label or device in a damaged pouch.
- i) The test device should be stored at 2 -30°C. And the test should be performed at room temperature.
- j) Do not reuse the test device.
- k) All spills should be wiped thoroughly using 0.5% sodium hypochlorite solution.

#### **7.19.10 Calibration**

Not applicable

#### **7.19.11 Quality Control**

- Known positive and negative control organism each time this procedure is performed.
- Check new batches of stain and reagents for correct reactions using colonies with known positive and negative organisms.
- Discard the slides and make a new batch if satisfactory results are not obtained.

#### **7.19.12 Procedure Steps**

- a) Using sterile inoculating loop, select 4-5 well-isolated colonies. Suspend growth in a tube of sterile saline or broth. Adjust the turbidity to form a suspension comparable to a McFarland 0.5 standard. Agitate this suspension thoroughly.
- b) Dip a swab into the suspension and express excess fluid by rotating the swab against the inside wall of the test tube.
- c) Inoculate the entire surface of a Mueller Hinton medium plate, streaking in three directions by rotating the plate 60° after each streaking. If the inoculum is satisfactory, there will be a confluent lawn of growth.
- d) Allow the inoculum to dry approximately 5 minutes with the lid in place.
- e) Using sterile forceps, place one novobiocin disk on the inoculated surface. Gently press the disc down to ensure complete contact with the agar. Do not move a disc once it has touched the agar because the novobiocin diffuses almost immediately.
- f) Invert and incubate at 35°C for 16 – 18 hours.
- g) Measure the zone of inhibition, if present, with a ruler or caliper

### **7.19.13 Interpretation and Reporting of Results**

*Positive*; A zone of inhibition greater than 16mm indicates that organism is sensitive to the antibiotic.

*Negative*; A zone of inhibition less than or equal to 16mm is indicative of novobiocin resistance

Report *Staphylococcus saprophyticus* if inhibition zone is less than or equal to 16mm

### **7.19.14 Biological Reference Intervals**

Not applicable

#### **Critical Value**

Not applicable

### **7.19.15 Limitation of the Procedure and Sources of Error**

- Novobiocin (5 µg) disks are intended for screening of novobiocin resistance only.
- They are not intended for determining the susceptibility of coagulase-negative staphylococci to novobiocin.
- Other less significant coagulase-negative *Staphylococcus* strains are also novobiocin resistant, such as *S. cohnii*, *S. xylosus* and *S. sciuri*.

### **7.19.16 Performance Characteristics**

Refer manufacturer performance characteristics compares to laboratory method verification report

### **7.19.17 Supporting Documents**

- Laboratory quality policy manual
- Laboratory safety policy manual
- Laboratory sample collection manual

### **7.19.18 References**

- a) Clinical Microbiology Procedures Handbook. American Society for Microbiology. Washington D.C., USA, 2<sup>nd</sup> edition, 2007.
- b) Monica cheesbrough (2005). District Laboratory Practice in Tropical countries. Cambridge University Press, New York, USA, 2<sup>nd</sup> edition, 2005.
- c) WHO, (2003). Manual of basic techniques for a health laboratory. Geneva. 2<sup>nd</sup> edition, 2003.
- d) Manual of Clinical Microbiology. American Society for Microbiology (ASM), Washington D.C., USA. 9<sup>th</sup> edition, 2007.
- e) Manual for the Laboratory Identification and Antimicrobial Susceptibility Testing of Bacterial Pathogens of Public Health Importance in the Developing World. U.S. Centers for Disease Control and Prevention (CDC), Atlanta, Georgia, U.S.A, and World Health Organization (WHO) Geneva Switzerland. 2003.

## **7.20 BACITRACIN TEST**

### **7.20.1 Purpose**

This procedure provides instructions for performing Bacitracin test

### **7.20.2 Scope**

This procedure provides instructions for performing Bacitracin test in the Laboratory

### **7.20.3 Responsibility**

The section heads and technical staffs are responsible for implementing this procedure.

### **7.20.4 Principle**

*Streptococcus pyogenes* (group A *Streptococcus*) is one of the most important pathogens encountered in clinical practice. In addition to infections of the upper respiratory tract and the skin, *S. pyogenes* can cause a wide variety of invasive systemic infections, and infection with this pathogen is also causally linked to 2 potentially serious nonsuppurative complications: acute rheumatic fever and acute glomerulonephritis. The bacitracin disk susceptibility test is commonly used to presumptively identify group A beta-hemolytic streptococci. Group A streptococcus is differentiated from other groups of beta-hemolytic streptococci by the formation of a zone of inhibition around a disk impregnated with 0.04 unit of bacitracin. The bacitracin disk is also a very sensitive assay to separate staphylococci from *Rothiamucilaginosus* (formerly *Stomatococcus mucilaginosus*) and *Micrococcus*. This separation is generally performed restrictively, usually on strains with pigment or sticky colony morphology from significant anatomic sites.

### **7.20.5 Sample Requirements**

Overnight growth of test isolate on Sheep Blood Agar. Test may be performed on isolates from primary culture plates. Organisms used for testing must be isolated and not mixed with normal flora.

### **7.20.6 Equipment**

Incubator and biosafety cabinet

### **7.20.7 Materials**

- Bacitracin disks
- Sheep blood agar (SBA) plates
- Sterile inoculating loop
- forceps

### **7.20.8 Storage and Stability**

- Store Media powder and disks according to manufacturer's instructions&specifications.
- Refrigerate prepared culture media on 2-8°C

- Return unused disks to refrigerator as soon as possible following manufacturer specification

### **7.20.9 Safety**

- Decontaminate working surfaces as recommended by IPC Guidelines
- Temperatures for the room and refrigerator are recorded as recommended by IPC Guidelines.
- Adhere to safety precautions as stated in the Safety manual
- All personal protective equipment (PPE) must be worn when performing this procedure.
- All samples must be regarded as potentially infectious.
- Refer to National infection prevention and control Guidelines for health waste management and safety practice.
- Avoid any contact between hands and eyes and nose during sample collection and testing.
- Do not use kit beyond the expiration date which appears on the package label or device in a damaged pouch.
- The test device should be stored at 2 -30°C. And the test should be performed at room temperature.
- Do not reuse the test device.
- All spills should be wiped thoroughly using 0.5% sodium hypochlorite solution.

### **7.20.10 Calibration**

Not applicable

### **7.20.11 Quality Control**

Known positive and negative control organisms each time this procedure is performed. Check new batches of stain and reagents for correct reactions using colonies with known positive and negative organisms.

Discard the slides and make a new batch if satisfactory results are not obtained.

### **7.20.12 Procedure Steps**

- Divide a blood agar plate into two halves and label appropriately.
- Using a loop, touch a colony of the test organism.
- Inoculate half the surface of sheep blood agar(SBA).
- Streak the plate in at least two directions to obtain confluent growth.
- Using sterile forceps, place a Bacitracin disk in the center of each inoculated area.
- Press disk gently with the sterile forceps so that the disk adheres firmly to the agar surface.
- Incubate plate at 35°C in 5 – 10% CO<sub>2</sub> for 18-24 hours.
- The next day, observe for zone of inhibition around the disk.
- Record results.

### **7.20.13 Biological Reference Intervals**

Not applicable

**Critical Value**

Not applicable

#### **7.20.14 Interpretation and Reporting of Results**

Interpretation

*Susceptible*: Any zone of inhibition

*Negative*: No zone of inhibition

#### **Reporting of Results**

- Any zone of inhibition, regardless of diameter, should be reported as “Beta-hemolytic *Streptococcus* presumptively group A by bacitracin.”
- No zone of inhibition (growth up to the edge of the disc) is reported as “Beta-hemolytic *Streptococcus* presumptively NOT group A by bacitracin.”
- For differentiation of *staphylococci* from micrococci and *Rothia*, use the bacitracin 0.04 U if an isolate is penicillin susceptible and from a significant body site. Coagulase negative staphylococci are resistant while *Micrococcus* and *Rothia* are susceptible. The latter also adheres to the agar. Zone of  $\geq 10$ mm is susceptible. Repeat tests with values between 7 and 10mm; these are probably susceptible. Zone sizes of  $>7$ mm but less than the 10mm breakpoint may be obtained for *Micrococcus* if incubation is not a full 24 hours.

#### **7.20.15 Limitation of the Procedure and Sources of Error**

- This test is highly sensitive but not specific. It has been reported that 6% of group B and 7.5% of groups C and G *streptococci* may produce zones of inhibition (false-positive result).
- The bacitracin disk test is presumptive, and a positive result should be followed with more specific physiological and/or serological tests. The bacitracin test may be performed in conjunction with sulfamethoxazole/trimethoprim (SXT) susceptibility disk. Group A strep is resistant to SXT. Superior to the bacitracin disk test in terms of accuracy and time to results is the PYR hydrolysis test. This test can be completed within a few minutes, compared to overnight incubation for the bacitracin disk test. However, the cost of the PYR hydrolysis test is slightly higher than the bacitracin disk test. Also very accurate are a variety of particle agglutination assays that detect Group A streptococcal antigen in colonies growing on culture plates. These methods furnish results within a few minutes that are essentially 100% sensitive and specific. Unfortunately, they are much more expensive than the bacitracin disk test.
- It should be noted that excessive inoculum concentration may result in the absence of a zone of inhibition (false-negative result) with some group A *streptococcus*. For differentiation of Staphylococci from *Micrococci*, use bacitracin susceptibility testing only for penicillin-susceptible or “sticky” colonies of gram-positive cocci in clusters which are catalase positive and coagulase negative from invasive-site samples. Do not test lemon yellow colonies



because they are presumed to be *Micrococcus*. While *Micrococcus* and *R. mucilaginosa* can be resistant to penicillin, this is a very rare event

#### **7.20.16 Performance Characteristics**

Refer manufacturer performance characteristics compares to laboratory method verification report

#### **7.20.17 Supporting Documents**

- Laboratory quality policy manual
- Laboratory safety policy manual
- Laboratory sample collection manual

#### **7.20.18 References**

- a) Clinical Microbiology Procedures Handbook. American Society for Microbiology. Washington D.C., USA, 2<sup>nd</sup> edition, 2007.
- b) Monica Cheesbrough (2005). District Laboratory Practice in Tropical countries. Cambridge University Press, New York, USA, 2<sup>nd</sup> edition, 2005.
- c) WHO, (2003). Manual of basic techniques for a health laboratory. Geneva. 2<sup>nd</sup> edition, 2003.
- d) Manual of Clinical Microbiology. American Society for Microbiology (ASM), Washington D.C., USA. 9<sup>th</sup> edition, 2007.
- e) Manual for the Laboratory Identification and Antimicrobial Susceptibility Testing of Bacterial Pathogens of Public Health Importance in the Developing World. U.S. Centres for Disease Control and Prevention (CDC), Atlanta, Georgia, U.S.A, and World Health Organization (WHO) Geneva Switzerland. 2003
- f) International Union against Tuberculosis and Lung Disease. The Public Health Service National Tuberculosis Reference Laboratory and the National Laboratory Network. Paris; 1998.
- g) Clinical Microbiology Procedure Handbook, ASM Press 2010. 1752 N. St., N.W. Washington DC 200336-2904, USA.
- h) World Health Organization. Laboratory services in tuberculosis. Part II: Microscopy. Geneva; 1998.

## 7.21 PYRROLIDONYL AMINOPEPTIDASE (PYR) TEST

### 7.21.1 Purpose

This procedure provides instructions for performing PYR test.

### 7.21.2 Scope

This procedure provides instructions for performing PYR test in the Laboratory

### 7.21.3 Responsibility

The section heads and technical staffs are responsible for implementing this procedure.

### 7.21.4 Principle

PYR is a rapid colorimetric method for presumptive identification of certain groups of bacteria such as Group A streptococci (*Streptococcus pyogenes*), *Enterococcus spp.*, some coagulase negative staphylococci, and some Enterobacteriaceae based on the activity of the enzyme L-pyrrolidonylarylamidase (also called pyrrolidonylaminopeptidase). Filter paper disks or strips are impregnated with L-pyrrolidonyl- $\beta$ - naphthylamide (PYR) which serves as a substrate for the detection of pyrrolidonylarylamidase (PYRase). Following hydrolysis of the substrate by the enzyme, the resulting beta-naphthylamine produces a red colour upon the addition of p- dimethylaminocinnamaldehyde (Color Developer).

### 7.21.5 Sample Requirements

- Use fresh growth (18-24 hours old) from sheep blood agar plate as inoculum
- Catalase-negative, beta-hemolytic, Gram-positive cocci with typical group A streptococcal morphology.
- Catalase-negative, gamma- or alpha-hemolytic, Gram-positive cocci with typical enterococcal morphology.
- Oxidase-negative, indole-positive, Gram-negative rods that are lactose positive on MacConkey agar (MAC), to identify *E. coli*.
- Coagulase-negative staphylococci, to screen for *Staphylococcus lugdunensis* and other staphylococci to the species level.

### 7.21.6 Equipment

Incubator at  $35 \pm 2^\circ\text{C}$  and Biosafety cabinet

### 7.21.7 Materials

Reagent	Consumables
Disks impregnated with PYR, 0.01% p-dimethylaminocinnamaldehyde reagent (disks are available commercially; both reagents are also available as a kit). Positive and negative Control slides for gram positive & negative organisms, respectively (if necessary).	Personal protective gears Sterile Plastic disposable/ wire loop Marker pen Small plastic sheet or gloves 0.5 McFarland standard, Forceps Ruler or caliper

### 7.21.8 Storage and Stability

Store Media powder and disks according to manufacturer's specifications.

Refrigerate prepared culture media on 2-8°C. The disk should be stored at refrigerator 2 - 8°C until the expiration dates and as manufacture instructions. Store Media powder and according to manufacturer's specifications. Refrigerate prepared culture media on 2-8°C

### 7.21.9 Safety

- a) Decontaminate working surfaces as recommended by IPC Guidelines
- b) Temperatures for the room and refrigerator are recorded as recommended by IPC Guidelines.
- c) Adhere to safety precautions as stated in the Safety manual
- d) All personal protective equipment (PPE) must be worn when performing this procedure.
- e) All samples must be regarded as potentially infections.
- f) Refer to National infection prevention and control Guidelines for health waste management and safety practice.
- g) Do not use kit beyond the expiration date which appears on the package label or device in a damaged pouch.
- h) All spills should be wiped thoroughly using 0.5% sodium hypochlorite solution.
- i) PYR powder or liquid is a carcinogen; making the reagent in the clinical laboratory is discouraged.

### 7.21.10 Calibration

Not applicable

### 7.21.11 Quality Control

- Known positive and negative control organisms each time this procedure is performed.
- Check new batches of stain and reagents for correct reactions using colonies with known positive and negative organisms.
- Discard the slides and make a new batch if satisfactory results are not obtained.

Quality control Organism	ATCC	Expected Results
<i>Enterococcus faecalis</i>	29212	Positive
<i>Streptococcus pyogenes</i>	19615	Positive
<i>Streptococcus agalactiae</i>	10386	Negative

### 7.21.12 Procedural Steps

#### Broth method

- Inoculate PYR broth with 3-5 colonies from 18-24 hours' pure culture.
- Incubate the tube aerobically at 35-37°C for 4 hours.
- Add 2-3 drop of PYR reagent and observe for color change.
- Observe for the red color development within 1-2 minutes

## Disk method

- Wet the PYR test disc on the strip with 10 µl sterile distilled water or deionized water.
- Put 5-10 colonies of the tested strain from 18-24 hours' culture on the surface of the disc with a loop and smear them lightly on it.
- Incubate the disc for 1-2 minutes at room temperature.
- After incubation, add 1 drop of N, N-dimethylaminocinnamaldehyde.
- Observe for red color development within 1-2 minutes.

### 7.21.13 *Biological Reference interval*

Not applicable

#### Critical Value

Not applicable

### 7.21.14 *Interpretation and Reporting of Results*

*Positive:* Bright pink or cherry-red colour within 1-2 minutes.

Examples: Group A *Streptococci* (*Streptococcus pyogenes*), Group D *Enterococci* (*Enterococcus faecalis* and *Enterococcus faecium*), Coagulase negative *Staphylococcus* species such as *S. hemolyticus*, *S. lugdunensis*, *S. schleiferi*, *Enterobacter*, *Citrobacter*, *Klebsiella*, *Yersinia* and *Serratia*, *Aerococcus*, *Gamella*, *Lactococcus*, most *Corynebacterium* (*Arcanobacterium*) *hemolyticum*.

*Negative:* No colour change or a blue colour due to a positive indole reaction.

Examples: Group B *Streptococci* (*Streptococcus agalactiae*), *Streptococcus mitis*, *S. bovis*, *S. equinus*, *S. milleri*.

*Note:* A pale pink reaction (weak) is considered negative.

#### Results Interpretation

# PYR Test

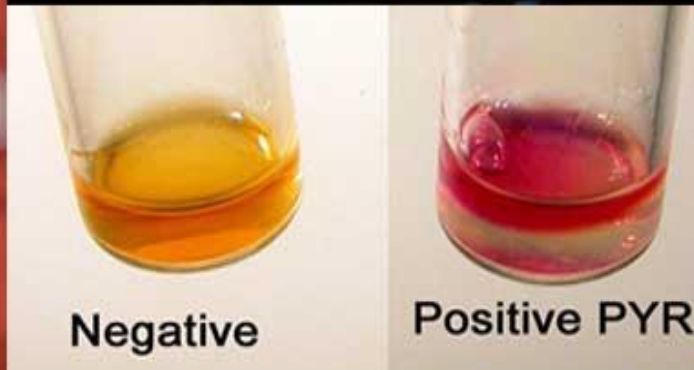
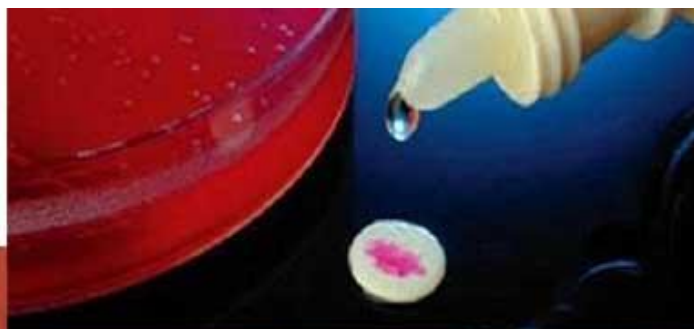
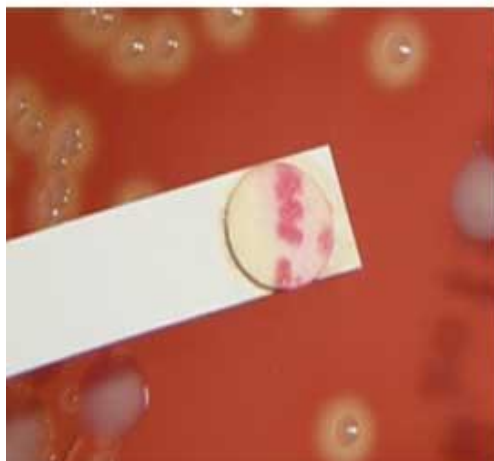

### **7.21.15      *Limitation of the Procedure and Sources of Error***

- a) PYR may be used in the presumptive separation of group A streptococci and group D enterococci from other streptococci. Additional testing, using a pure culture, is recommended for complete identification.
- b) A false-negative test can result if the disk or filter papers are too moist.
- c) False-negative tests can result if selective media or tube biochemical agars are used to provide inocula.
- d) *Escherichia coli* and indole-positive *Proteus* obtained from media containing high tryptophan content may yield a blue-green color development. This is a negative result.
- e) Non-specific colour reactions may occur if results are read after 20 seconds

### **7.21.16      *Performance Characteristics***

Not applicable

### **7.21.17      *Supporting Documents***

- Laboratory quality policy manual, Laboratory safety policy manual

### **7.21.18      *References***

1. PYR (L-Pyrrolidonyl-b-Naphthylamide) Test. Chapter 3.17.41. Clinical Microbiology Procedures Handbook. Volume 1. Second Edition Update (2007).
2. L-Pyrrolidonyl Arylamidase (PYR) Test. Procedure 13-36. Bailey & Scott's Diagnostic Microbiology.
3. Monica Cheesbrough. District Laboratory Practice in Tropical Countries. Second Edition. Part 2. Chapter 7 Microbiological Test. 7.18.2 *Streptococcus pyogenes*. pp- 160.

## **7.22 OPTOCHIN TEST**

### **7.22.1 Purpose**

This procedure provides instructions for performing Optochin test.

### **7.22.2 Scope**

This procedure provides instructions for performing Optochin test in the Laboratory

### **7.22.3 Responsibility**

The section heads and technical staffs are responsible for implementing this procedure.

### **7.22.4 Principle**

Optochin susceptibility test is used in the rapid differentiation and presumptive identification of *Streptococcus pneumoniae*. The test is performed with a 6-mm disk impregnated with 5µg ethylhydrocupreine hydrochloride (Optochin). Optochin susceptibility testing differentiates *S. pneumoniae* from other alpha-hemolytic streptococci. The growth of pneumococci, but not other streptococci, is markedly inhibited by Optochin

### **7.22.5 Sample Requirements**

A 18-24 hour old culture of colonies suggestive of *S. pneumoniae* (alpha-hemolytic, catalase negative, Gram positive cocci in pairs).

### **7.22.6 Equipment**

Incubator at  $35 \pm 2^{\circ}\text{C}$

### **7.22.7 Materials**

Optochin disks (5  $\mu\text{g}$ ), Sheep Blood Agar Plate, Personal protective gears, Sterile Plastic disposable/ wire loop, Marker pen, Small plastic sheet or gloves, 0.5 McFarland standard, Forceps, Ruler or caliper

### **7.22.8 Storage and Stability**

Store Media powder and disks according to manufacturer's specifications.

Refrigerate prepared culture media on  $2-8^{\circ}\text{C}$

### **7.22.9 Safety**

- a) Decontaminate working surfaces as recommended by IPC Guidelines
- b) Temperatures for the room and refrigerator are recorded as recommended by IPC Guidelines.
- c) Adhere to safety precautions as stated in the Safety manual
- d) All personal protective equipment (PPE) must be worn when performing this procedure.
- e) All samples must be regarded as potentially infections.
- f) Refer to National infection prevention and control Guidelines for health waste management and safety practice.
- g) Avoid any contact between hands and eyes and nose during sample collection and testing.
- h) Do not use kit beyond the expiration date which appears on the package label or device in a damaged pouch.
- i) The test device should be stored at  $2-30^{\circ}\text{C}$ . And the test should be performed at room temperature.
- j) Do not reuse the test device.
- k) All spills should be wiped thoroughly using 0.5% sodium hypochlorite solution.

### **7.22.10 Calibration**

Not applicable

### **7.22.11 Quality Control**

- Known positive and negative control organisms each time this procedure is performed.
- Check new batches of stain and reagents for correct reactions using colonies with known positive and negative organisms.
- Discard the slides and make a new batch if satisfactory results are not obtained.

### **7.22.12 Procedure Steps**

- a) Using an inoculating loop, select a well isolated colony of the alpha-hemolytic organism to be tested.
- b) Directly streak the isolate onto Sheep Blood Agar Plate (SBA) plate in at least two directions so as to obtain confluent growth.
- c) Several isolates may be placed on one plate by dividing the plate into quadrants and streaking one isolate per quadrant.
- d) Using sterile forceps, place an Optochin disk onto the inoculated surface of the agar.
- e) Press disk gently with the sterile forceps so that the disk adheres firmly to the agar surface.
- f) Incubate the plate at  $35 \pm 2^\circ\text{C}$  for 18-24 hours in 5-10%  $\text{CO}_2$ .
- g) If zone of inhibition is present, measure the diameter with the millimetre ruler or calliper

### **7.22.13 Interpretation and Reporting of Results**

*Optochin Susceptible* - report as *Streptococcus pneumoniae*.

*Optochin Intermediate* - perform **spot bile solubility** test for confirmation of identification. If positive report as *Streptococcus pneumoniae*.

*Optochin Resistant* - report as *Viridans group Streptococcus*.

### **7.22.14 Biological Reference Intervals**

Not applicable

#### **Critical Value**

Not applicable

### **7.22.15 Limitation of the Procedure and Sources of Error**

- a) Use of media other than 5% Sheep Blood Agar is not recommended, as smaller zone can result in lack of definitive identification.
- b) *S. pneumoniae* isolates should be incubated in a  $\text{CO}_2$  enriched environment, as some isolates will grow poorly or not at all without increased  $\text{CO}_2$ .
- c) If the organism is Optochin resistant, it is likely to be non-pneumococcal alpha-hemolytic streptococcus; however, rare exceptions have been reported.
- d) Optochin susceptibility is an excellent test to identify *S. pneumoniae*, with 99% sensitivity for encapsulated strains and 98-99% specificity.
- e) If there are colonies present within the zone of inhibition, these colonies may or may not be pneumococci. Subculture such colonies to determine if they are contaminants or pneumococci prior to reporting susceptibility results.

### **7.22.16 Performance Characteristics**

Refer manufacturer performance characteristics compares to laboratory method verification report

### **7.22.17 Supporting Documents**

- Laboratory quality policy manual
- Laboratory safety policy manual

- Laboratory sample collection manual

### **7.22.18 References**

1. Clinical Microbiology Procedures Handbook. American Society for Microbiology. Washington D.C., USA, 2<sup>nd</sup> edition, 2007.
2. Monica cheesbrough (2005). District Laboratory Practice in Tropical countries. Cambridge University Press, New York, USA, 2<sup>nd</sup> edition, 2005.
3. WHO, (2003). Manual of basic techniques for a health laboratory. Geneva. 2<sup>nd</sup> edition, 2003.
4. Manual of Clinical Microbiology. American Society for Microbiology (ASM), Washington D.C., USA. 9<sup>th</sup> edition, 2007.
5. Manual for the Laboratory Identification and Antimicrobial Susceptibility Testing of Bacterial Pathogens of Public Health Importance in the Developing World. U.S. Centers for Disease Control and Prevention (CDC), Atlanta, Georgia, U.S.A, and World Health Organization (WHO) Geneva Switzerland. 2003
6. International Union against Tuberculosis and Lung Disease. The Public Health Service National Tuberculosis Reference Laboratory and the National Laboratory Network. Paris; 1998.
7. Clinical Microbiology Procedure Handbook, ASM Press 2010. 1752 N. St., N.W.Washington DC 200336-2904, USA.

## **7.23 BILE SOLUBILITY TEST**

### **7.23.1 Purpose**

This procedure provides instructions for performing Bile Solubility test.

### **7.23.2 Scope**

This procedure is to be used for performing Bile Solubility test in the laboratory.

### **7.23.3 Responsibility**

The section heads and technical staffs are responsible for implementing this procedure

### **7.23.4 Principle**

bile solubility test is used to differentiate *Streptococcus pneumoniae* from alpha-hemolytic *Streptococcus spp.* It can be performed using either the “tube method” or the “plate method.” The bile solubility test is based on the observation that pneumococcal cells lyse when sodium desoxycholate (bile salts) is applied to the colony under specified conditions of time and temperature. The pneumococcus has an intracellular autolytic enzyme, an amidase that cause the organism to undergo rapid autolysis when cultivated on artificial medium. The bile salts alter the surface tension of the medium and cause cell membrane rearrangement. The working mechanism of the test is not clearly understood; however, one theory is that the bile salts facilitate lysis of pneumococcal cells by activating the autolytic enzyme.

### **7.23.5 Sample Requirements**



- Any alpha-hemolytic colonies on sheep blood agar (18-24 hour old) suggestive of *S. pneumoniae*: catalase negative, Gram positive cocci in pairs or chains, having the characteristic central depression (flattened center) or mucoid colony morphology.
- Colonies from suspected *S. pneumoniae* on Sheep Blood Agar bile solubility test (SBA) that are Optochin Intermediate.

### 7.23.6 Equipment

Biosafety cabinet

### 7.23.7 Materials

Reagent	Consumables
10% Sodium desoxycholate Dilute 1g of Sodium desoxycholate to 10 ml of deionized water. Store at 15 – 30 °C with shelf life of 6 months. Sterile 0.85 % NaCl (NSS).	a) Personal protective equipment b) Marker pen c) Sterile wooden applicator sticks d) Inoculating Loops e) Test tubes, 12 x 75mm f) Sterile Pasteur (transfer) pipettes

### 7.23.8 Storage and Stability

Store Media powder and disks according to manufacturer's specifications.

Refrigerate prepared culture media on 2-8°C

### 7.23.9 Safety

- Decontaminate working surfaces as recommended by IPC Guidelines
- Temperatures for the room and refrigerator are recorded as recommended by IPC Guidelines.
- Adhere to safety precautions as stated in the Safety manual
- All personal protective equipment (PPE) must be worn when performing this procedure.
- All samples must be regarded as potentially infections.
- Refer to National infection prevention and control Guidelines for health waste management and safety practice.
- Avoid any contact between hands and eyes and nose during sample collection and testing.
- Do not use kit beyond the expiration date which appears on the package label or device in a damaged pouch.
- The test device should be stored at 2 -30°C. And the test should be performed at room temperature.
- Do not reuse the test device.
- All spills should be wiped thoroughly using 0.5% sodium hypochlorite solution.

### 7.23.10 Calibration

All auxiliary equipment should be calibrated annually

### **7.23.11 Quality Control**

- Known positive and negative control organisms each time this procedure is performed.
- Check new batches of stain and reagents for correct reactions using colonies with known positive and negative organisms.
- Discard the slides and make a new batch if satisfactory results are not obtained.

### **7.23.12 Procedure Steps**

#### **Test tube method**

- a) Dispense 0.5 ml of NSS into a small test tube.
- b) Take a loop of the suspect strain from fresh growth on SBA and prepare heavy suspension of the organism (No.1 McFarland Standard). Shake to form a uniform suspension.
- c) Divide the suspension into two tubes, one labeled "TEST" and the other labeled "CONTROL".
- d) Dispense 5 drops of bile reagent into the tube marked "TEST"
- e) Add 5 drops of NSS to the tube marked "CONTROL".
- f) Gently mix each tube.
- g) Incubate the tubes for 3 hours at  $35 \pm 2^{\circ}\text{C}$ , checking hourly for clearing.
- h) Observe for clearing in "TEST" suspension. The "CONTROL" suspension should remain turbid.

#### **Direct Plate Method**

- a) Place a drop of bile reagent near a suspected 18-24 hour colony.
- b) Gently roll the drop over several representative colonies by tilting the plate.
- c) Keep the plate right side up and incubate at  $35 \pm 2^{\circ}\text{C}$  for 15-30 minutes or until the reagent drop has evaporated.
- d) Observe for flattening of the colony. Be sure the colony did not simply float away

### **7.23.13 Biological Reference Intervals**

Not applicable

#### **Critical Value**

Not applicable

### **7.23.14 Interpretation and Reporting of Results**

- Report as *Streptococcus pneumoniae*, if either the tube test or direct plate bile solubility is positive from alpha hemolytic colony of gram positive cocci in pairs and tested catalase negative.
- Report as Viridans group Streptococcus, if the test does not demonstrate bile solubility from alpha hemolytic colony of Gram positive cocci in pairs and tested catalase negative.

#### **Results Interpretation**

### **Test tube method**

Positive Test (Bile soluble): clearing of the test suspension within 3 hours, control suspension remains turbid.

Negative Test (Bile insoluble): test and control suspensions remain turbid within 3 hours.

### **Direct Plate Method**

*Positive Test* (Bile soluble): disintegration or flattening of the colony within 30 minutes, leaving an area of alpha-hemolysis where the colonies were located.

Negative Test (Bile insoluble): colony remains intact within 30 minutes.

#### **7.23.15 Limitation of the Procedure and Sources of Error**

- a) Test only on alpha hemolytic colony of a Gram positive cocci in pairs and is catalase negative, to differentiate *S. pneumoniae* from other alpha hemolytic streptococci.
- b) The bile solubility test is not reliable with old cultures; organism may have lost its active enzyme resulting in a false negative result.
- c) Some *S. pneumoniae* organisms will not lyse in the presence of bile, possibly due to the loss of virulence factor or capsule. If lysis is not present, the isolate may still be *S. pneumoniae*. Therefore, colonies resembling pneumococcus which are not bile soluble should be further identified using another method, such as Optochin susceptibility and/or DNA probe.
- d) When testing using plate method, care must be taken not to dislodge the colony being tested, thus leading to false positive results. If the direct plate is difficult to interpret, the test should be repeated using the tube method.
- e) Storage of the reagent at a cool temperature can cause it to thicken. Warm the reagent bottle in a 35°C incubator to liquefy the reagent before use

#### **7.23.16 Performance Characteristics**

Refer manufacturer performance characteristics compares to laboratory method verification report

#### **7.23.17 Supporting Documents**

- Laboratory quality policy manual
- Laboratory safety policy manual
- Laboratory sample collection manual

#### **7.23.18 References**

1. Clinical Microbiology Procedures Handbook. American Society for Microbiology. Washington D.C., USA, 2<sup>nd</sup> edition, 2007.
2. Monica cheesbrough (2005). District Laboratory Practice in Tropical countries. Cambridge University Press, New York, USA, 2<sup>nd</sup> edition, 2005.
3. WHO, (2003). Manual of basic techniques for a health laboratory. Geneva. 2<sup>nd</sup> edition, 2003.
4. Manual of Clinical Microbiology. American Society for Microbiology (ASM), Washington D.C., USA. 9<sup>th</sup> edition, 2007.

5. Manual for the Laboratory Identification and Antimicrobial Susceptibility Testing of Bacterial Pathogens of Public Health Importance in the Developing World. U.S. Centers for Disease Control and Prevention (CDC), Atlanta, Georgia, U.S.A, and World Health Organization (WHO) Geneva Switzerland. 2003
6. International Union against Tuberculosis and Lung Disease. The Public Health Service National Tuberculosis Reference Laboratory and the National Laboratory Network. Paris; 1998.
7. Clinical Microbiology Procedure Handbook, ASM Press 2010. 1752 N. St., N.W. Washington DC 200336-2904, USA.
8. World Health Organization. Laboratory services in tuberculosis. Part II: Microscopy. Geneva; 1998.

## 7.24 INDOLE TEST

### 7.24.1 Purpose

- This procedure provides instructions for performing Indole tes

### 7.24.2 Scope

- This procedure provides instructions for performing Indole test in the Laboratory

### 7.24.3 Responsibility

- The section heads and technical staffs are responsible for implementing this procedure

### 7.24.4 Principle

- The Indole Test is used for the determination of the organism's ability to produce indole from deamination of tryptophan by tryptophanase. Indole if present combines with the aldehyde in the reagent to produce a pink to red-violet quinodal compound (benzaldehyde reagent) or blue to green color (cinnamaldehyde reagent).

### 7.24.5 Sample Requirements

- Fresh growth (18-24hours) of gram negative rod on medium that does not contain dyes and contains tryptophan e.g. Blood Agar Plate (BAP), Chocolate Agar (CA).

### 7.24.6 Equipment

- Biosafety cabinet or fume hood

### 7.24.7 Materials

Reagent	Consumables
<ul style="list-style-type: none"><li>• Kovacs reagent Indole reagents (1% or 5%)</li></ul> <p><b>Caution:</b> Hydrogen Chloride (HCl) is toxic and burns. Make indole reagents in a fume hood. Add acid to water; do not add water to acid.</p>	<ul style="list-style-type: none"><li>a) PPE</li><li>b) Glass slides</li><li>c) Inoculating loop</li><li>d) Applicator sticks</li><li>e) Sterile loop</li><li>f) stick or swab</li><li>g) Filter paper</li></ul>

### 7.24.8 Storage and Stability

- a) Store Media powder according to manufacturer's specifications.
- b) Refrigerate prepared culture media on 2-8°C

### 7.24.9 Safety

- a) Adhere to safety precautions as stated in the Safety manual
- b) All personal protective equipment (PPE) must be worn when performing this procedure.
- c) All samples must be regarded as potentially infections.

- d) Refer to National infection prevention and control Guidelines for health waste management and safety practice.
- e) Avoid any contact between hands and eyes and nose during sample collection and testing.
- f) Do not use kit beyond the expiration date which appears on the package label or device in a damaged pouch.
- g) All spills should be wiped thoroughly following national Infection and prevention guidelines

#### **7.24.10 Calibration**

- All auxiliary equipment should be calibrated annually

#### **7.24.11 Quality Control**

- Use of known microorganism for specified biochemical test (ATCC organism).
- Check new batches of stain and reagents for correct reactions using colonies with known positive and negative organisms.
- Discard the slides and make a new batch if satisfactory results are not obtained.

#### **7.24.12 Procedural Steps**

##### **Rapid spot Indole**

##### **Filter paper method**

- Moisten filter paper with reagent.
- Using sterile loop or sterile wooden stick rub portion of colony onto the moistened filter paper.
- Then observe for color change within 2 minutes.

##### **Swab Method**

- Sweep the colony onto a sterile swab.
- Add drop of indole reagent to the colony swab.
- Observe for color change within 2 minutes.

##### **Tube Test**

- a) Inoculate liquid tube medium or stab agar medium (e.g., SIM) with colony.
- b) Incubate for 18-24 hours. If broth is used for indole production, pipette a portion of the medium to a second tube for testing. Use second tube for testing.
- c) Add 3 drops of Kovac's reagent down the side of tube and observe color change at meniscus.
- d) If test is negative, repeat after additional 24 hours incubation, if desired.

#### **7.24.13 Biological Reference Intervals**

- Not applicable
- *Critical value*
  - Not applicable

#### **7.24.14 Interpretation and Reporting of Results**

- *Positive Test:* development of a brown-red to purple-red color (benzaldehyde reagents) or blue color (cinnamaldehyde reagent) within 2 minutes indicates the presence of indole
- *Negative Test:* colorless or slightly yellow (benzaldehyde reagents)
- No color change or pinkish tinge (cinnamaldehyde reagent)

#### **7.24.15      15.0    *Limitation of the Procedure and Sources of Errors***

Glucose inhibit indole production; therefore, indole should not be done on media containing glucose

The indole is not specific for any particular bacteria species

The indole tests are subjective to its interpretation

Some media such as MCA containing dyes that interfere with indole reactions

#### **7.24.16      *Performance Characteristics***

Refer manufacturer performance characteristics compares to laboratory method verification report

#### **7.24.17      *Supporting Documents***

- Laboratory quality policy manual
- Laboratory safety policy manual
- Laboratory sample collection manual

#### **7.24.18      *References***

- a) Clinical Microbiology Procedures Handbook. American Society for Microbiology. Washington D.C., USA, 2<sup>nd</sup> edition, 2007.
- b) Monica Cheesbrough (2005). District Laboratory Practice in Tropical countries. Cambridge University Press, New York, USA, 2<sup>nd</sup> edition, 2005.
- c) WHO, (2003). Manual of basic techniques for a health laboratory. Geneva. 2<sup>nd</sup> edition, 2003.
- d) Manual of Clinical Microbiology. American Society for Microbiology (ASM), Washington D.C., USA. 9<sup>th</sup> edition, 2007.
- e) Manual for the Laboratory Identification and Antimicrobial Susceptibility Testing of Bacterial Pathogens of Public Health Importance in the Developing World. U.S. Centers for Disease Control and Prevention (CDC), Atlanta, Georgia, U.S.A, and World Health Organization (WHO) Geneva Switzerland. 2003
- f) International Union against Tuberculosis and Lung Disease. The Public Health Service National Tuberculosis Reference Laboratory and the National Laboratory Network. Paris; 1998.

## **7.25 OXIDASE TEST**

### **7.25.1 Purpose**

This procedure provides instructions for performing Oxidase test

### **7.25.2 Scope**

This procedure provides instructions for performing Oxidase test in the Laboratory

### **7.25.3 Responsibility**

The section heads and technical staffs are responsible for implementing this procedure

### **7.25.4 Principle**

Oxidase test is used to detect the production of the enzyme cytochrome oxidase by bacteria. In the presence of atmospheric oxygen, a bacterium's intracellular cytochrome oxidase enzymes oxidize the phenylenediamine reagent (an electron acceptor) to form a deep purple compound, indophenol. The test is useful in the initial characterization of gram negative bacteria. In addition, oxidase testing can aid in rapid identifications, avoiding need for costlier kit identifications.

### **7.25.5 Sample Requirements**

Isolated colonies from 18-24-hour old culture grown on a solid agar medium (Blood Agar Plate, Mueller-Hinton agar, Brain Heart Infusion, or Chocolate)

### **7.25.6 Equipment**

Biosafety cabinet or fume hood

### **7.25.7 Materials**

<b>Reagent</b>	<b>Consumables</b>
Filter paper sterile wooden sticks or inoculating loops/wires Cryovials Kovac's oxidase reagent (1% tetramethyl-p-phenylenediamine dihydrochloride)	Personal protective gears Sterile Plastic disposable/ wire loop Marker pen Small plastic sheet or gloves Pasture pipette or Micropipette Sterile wooden applicator stick

### **7.25.8 Storage and Stability**

- Store Media powder according to manufacturer's specifications.
- Refrigerate prepared culture media on 2-8°C

### **7.25.9 Safety**

- a) Adhere to safety precautions as stated in the Safety manual
- b) All personal protective equipment (PPE) must be worn when performing this procedure.
- c) All samples must be regarded as potentially infections.
- d) Refer to National infection prevention and control Guidelines for health waste management and safety practice.
- e) Avoid any contact between hands and eyes and nose during sample collection and testing.



- f) Do not use kit beyond the expiration date which appears on the package label or device in a damaged pouch.
- g) All spills should be wiped thoroughly using 0.5% sodium hypochlorite solution.

#### **7.25.10 Calibration**

- Not applicable

#### **7.25.11 Quality Control**

- Known positive and negative control organisms each time this procedure is performed.
- Check new batches of stain and reagents for correct reactions using colonies with known positive and negative organisms.
- Discard the slides and make a new batch if satisfactory results are not obtained.

<b>Quality control Organism</b>	<b>ATCC</b>	<b>Expected Results</b>
<i>Enterococcus faecalis</i>	29212	Positive
<i>Streptococcus pyogenes</i>	19615	Positive
<i>Streptococcus agalactiae</i>	10386	Negative

#### **7.25.12 Procedural Steps**

##### **Filter paper method**

- Moisten filter paper with reagent.
- Using sterile loop or wooden stick rub portion of colony onto the moistened filter paper.
- Observe for color change within 10-60 seconds.

##### **Swab Method**

- Sweep the colony onto a sterile swab.
- Add drop of oxidase reagent to the colony swab.
- Observe for color change within 10-60 seconds.

#### **7.25.13 Biological Reference Intervals**

- Not Applicable

##### **Critical value**

- Not applicable

#### **7.25.14 Interpretation and Reporting of Results**

- Report as oxidase test positive or oxidase test negative.

*Positive Oxidase test:* Development of a deep blue to purple color in 10-30 seconds is a positive reaction.

*Weak positive test:* Development of the color in 30-60 seconds is a weak reaction, characteristic of many Pasteurellaspp and do not read after 60 seconds.

*Negative Oxidase test* is no color change in 60 seconds.

- Do not interpret result after 60 seconds

### **7.25.15      *Limitation of the Procedure and Sources of Errors***

The oxidase should not be done on media containing glucose or dyes

The oxidase is not specific for any particular bacteria species

The temperature at which the test is performed should not be too hot or too cold the reaction may not occur

### **7.25.16      *Performance Characteristics***

Refer manufacturer performance characteristics compares to laboratory method verification report

### **7.25.17      *Supporting Documents***

Laboratory quality policy manual

Laboratory safety policy manual

Laboratory sample collection manual

### **7.25.18      *References***

- i. Clinical Microbiology Procedures Handbook. American Society for Microbiology. Washington D.C., USA, 2<sup>nd</sup> edition, 2007.
- ii. Monica Cheesbrough (2005). District Laboratory Practice in Tropical countries. Cambridge University Press, New York, USA, 2<sup>nd</sup> edition, 2005.
- iii. WHO, (2003). Manual of basic techniques for a health laboratory. Geneva. 2<sup>nd</sup> edition, 2003.
- iv. Manual of Clinical Microbiology. American Society for Microbiology (ASM), Washington D.C., USA. 9<sup>th</sup> edition, 2007.
- v. Manual for the Laboratory Identification and Antimicrobial Susceptibility Testing of Bacterial Pathogens of Public Health Importance in the Developing World. U.S. Centers for Disease Control and Prevention (CDC), Atlanta, Georgia, U.S.A, and World Health Organization (WHO) Geneva Switzerland. 2003
- vi. International Union against Tuberculosis and Lung Disease. The Public Health Service National Tuberculosis Reference Laboratory and the National Laboratory Network. Paris; 1998.
- vii. Clinical Microbiology Procedure Handbook, ASM Press 2010. 1752 N. St., N.W. Washington DC 200336-2904, USA.
- viii. World Health Organization. Laboratory services in tuberculosis. Part II: Microscopy. Geneva; 1998.

## **7.26 UREASE TEST**

### **7.26.1 Purpose**

This procedure provides instructions for performing Urease test.

### **7.26.2 Scope**

This procedure is to be used for performing Urease test in the Laboratory

### **7.26.3 Responsibility**

Trained and competent medical scientist/technologist is responsible in implementing this procedure

#### **7.26.4 Principle**

The urease test is used to determine the ability of an organism to produce urease enzyme which split urea to produce ammonia and CO<sub>2</sub> gas. Two units of ammonia are formed with resulting alkalinity in the presence of an enzyme, and the increased pH is detected by pH indicator.

Christensen's urea medium contains the pH indicator phenol red that under acid condition (pH 6.8) is yellow. In alkaline condition (pH 8.4) the indicator turns the medium rose pink.

#### **7.26.5 Sample Requirements**

Fresh growth of single isolated colonies 18-24 hours of incubation from primary culture media such as blood agar, chocolate agar or nutrient agar or MCA

#### **7.26.6 Equipment**

Incubator and Biological Safety Cabinet

#### **7.26.7 Materials**

Christensen's Urea Medium, Sterile plastic Pasteur pipettes and Straight inoculating needle/wire loop

#### **7.26.8 Storage and Stability**

- Store Media powder according to manufacturer's specifications.
- Refrigerate prepared culture media on 2-8°C

#### **7.26.9 Safety**

- Decontaminate working surfaces as recommended by IPC Guidelines
- Temperatures for the room and refrigerator are recorded as recommended by IPC Guidelines.
- Adhere to safety precautions as stated in the Safety manual
- All personal protective equipment (PPE) must be worn when performing this procedure.
- All samples must be regarded as potentially infectious.
- Refer to National infection prevention and control Guidelines for health waste management and safety practice.
- Avoid any contact between hands and eyes and nose during sample collection and testing.
- Do not use kit beyond the expiration date which appears on the package label or device in a damaged pouch.
- The test device should be stored at 2 -30°C. And the test should be performed at room temperature.
  - Do not reuse the test device.
- All spills should be wiped thoroughly using 0.5% sodium hypochlorite solution.

#### **7.26.10 Calibration**

Not applicable

#### **7.26.11 Quality Control**

- Known positive and negative control organisms each time this procedure is performed.
- Check new batches of stain and reagents for correct reactions using colonies with known positive and negative organisms.
- Discard the slides and make a new batch if satisfactory results are not obtained.

#### **7.26.12 Procedure Steps**

- Inoculate slope over the entire surface and stab with straight inoculating needle.
- Incubate inoculated slope at  $35^{\circ}\text{C} \pm 2^{\circ}\text{C}$  with a loosen cap.
- Examine slopes after overnight incubation.

#### **7.26.13 Biological Reference Intervals**

- Not applicable

#### **Critical Value**

- Not applicable

#### **7.26.14 Interpretation and Reporting of Results**

Observe the development of pink colour.

*Urease positive:* growth will be visible on the slant surface and the medium will be an intense pink.

*Urease negative:* trace or no growth will be visible. No colour change will occur;

#### **7.26.15 Limitation of the Procedure and Sources of Error**

- Urease test can be affected by pH of certain media
- Can be affected by presence of certain antibiotic such tetracycline
- The urease test is not specific for any particular bacteria species
- The temperature at which the test is performed should not be too hot or too cold the reaction may not occur

### **7.26.16 Performance Characteristics**

Refer manufacturer performance characteristics compares to laboratory method verification report

### **7.26.17 Supporting Documents**

- Laboratory quality policy manual
- Laboratory safety policy manual
- Laboratory sample collection manual

### **7.26.18 References**

- Murray PA, et al. Manual of Clinical Microbiology, 8<sup>th</sup> Edition, 2003, p 355
- Murray PA, et al. Manual of Clinical Microbiology, 8th ed., 2003, pp 411-412
- Murray PA, et al. Manual of Clinical Microbiology, 8th ed., 2003, pp 409- 410
- Murray PA, et al. Manual of Clinical Microbiology, 8th ed., 2003, p 438.
- Difco and BBL Manual for Microbiological Culture Media. Maryland, U.S.A., Becton, Dickinson and Company. 2003.
- Clinical Microbiology Procedure Handbook, Volume 1, 3<sup>rd</sup> Edition, 2000
- L.M. de Laza et al., Color Atlas of Medical Bacteriology, ASM Press, 2004
- Cheesbrough, M. District Laboratory Practice in Tropical Countries, 2<sup>nd</sup> Edition, Tropical Health Technology, 2006, p163.
- UK Standard for Microbiology Investigations, Identification of Pasteurella species and Morphologically Similar Organisms, NHS, Public Health England, Bacteriology-Identification/ID 12/, Issue No: 3, Issue date: 4.02.15.
- Procedure for the use of API Strips. Whittington Hospital SOP MB/040.04 (2005).
- <https://biologypractical.com/tsi-triple-sugar-iron-test-objectiveprinciple-procedure-and-result/>

## **7.27 TRIPLE SUGAR IRON/KIA**

### **7.27.1 Purpose**

This procedure provides instructions for performing Triple Sugar Iron test in the Laboratory

### **7.27.2 Scope**

The aim of this procedure is to provide a guide on performing Triple Sugar Iron test

### **7.27.3 Responsibility**

Trained and competent medical scientist/technologist is responsible in implementing Triple Sugar Iron test

### **7.27.4 Principle**

Triple sugar iron test is used to determine whether gram negative bacilli utilize glucose and lactose or sucrose fermentative, and produce hydrogen sulphide (H<sub>2</sub>S). It contains 10 parts of lactose: 10 parts of sucrose: 1 part of glucose and peptone. Phenol red and ferrous sulphate serves as an indicator for acidification of medium and (H<sub>2</sub>S) production, respectively.

Glucose is utilized first by fermentative organism and the entire medium becomes acidic (yellow) in 8 to 12 hours. Butt remains acidic even after 18-24 hours of incubation because of the presence of organic conditions. The slant everts to alkaline state that is indicated by red colour as the fermentation products gets oxidised to carbon dioxide and water. Then, peptone in aerobic condition undergoes oxidation releasing alkaline amines on the slant (phenol red in alkaline pH turns red while in acidic pH turns yellow).

### **7.27.5 Sample Requirements**

- Fresh growth of single isolated colonies 18-24 hours of incubation from primary culture media such as blood agar, chocolate agar, nutrient agar or MCA.

### **7.27.6 Equipment**

Incubator and Biological Safety Cabinet

### **7.27.7 Materials**

TSI medium and straight inoculating needle or disposable inoculating loop

### **7.27.8 Safety**

- a) Adhere to safety precautions as stated in the Safety manual
- b) All personal protective equipment (PPE) must be worn when performing this procedure.
- c) All samples must be regarded as potentially infections.
- d) Refer to National infection prevention and control Guidelines for health waste management and safety practice.
- e) Do not use kit beyond the expiration date which appears on the package label or device in a damaged pouch.

### **7.27.9 Storage and Stability**

- Store Media powder according to manufacturer's specifications.
- Refrigerate prepared culture media on 2-8°C

### **7.27.10 Calibration**

- Not applicable

### **7.27.11 Quality Control**

- Use of known microorganism for specified biochemical test (ATCC organism).
- Check new batches of stain and reagents for correct reactions using colonies with known positive and negative organisms.
- Discard the slides and make a new batch if satisfactory results are not obtained.

### **7.27.12 Procedure Steps**

- Using sterile inoculating needle, stab the TSI slant about 2/3 of the way into the butt, withdraw the needle and streak the slant.
- Incubate aerobically at 35°C to 37°C with loosen cap.
- Examine after 18-24 hours of incubation

### **Results Interpretation:**

#### **Ability of bacteria to ferment sugar**

Fermentation of only glucose	Fermentation of glucose & lactose	Neither glucose nor lactose fermented
------------------------------	-----------------------------------	---------------------------------------

- Single gas bubble or bubbles in the medium
- Splitting of the medium
- Complete displacement of the medium from the bottom of the tube leaving a clear area
- Slight indentation of the medium from the side of the tube

#### **H<sub>2</sub>S production**

- The presence of black precipitate is evident by a black colour spread throughout the entire butt masking the acidity; may even be slight evidence on the slant
- A black ring near the top of the butt area
- A black precipitate scattered throughout the butt but not entirely.

## TSI Reactions

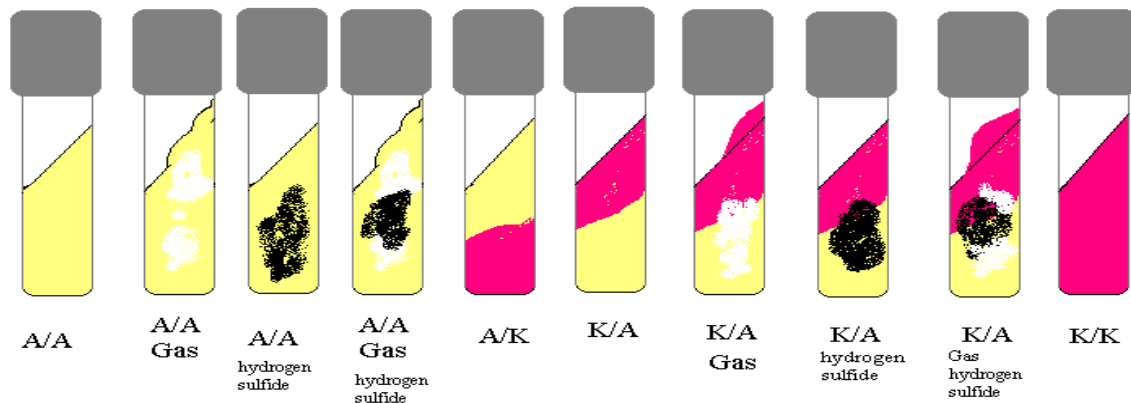

**Figure 2: TSI Reactions**

### **7.27.13 Biological Reference Intervals**

Not applicable

### **7.27.14 Critical Value**

Not applicable

### **7.27.15 Interpretation and Reporting of Results**

- See annex 6.1 and 6.2: Charts for Biochemical Identification of common Enterobacteriaceae and other enteric organisms. An acid/acid (yellow slant/yellow butt) reaction: It indicates the fermentation of dextrose, lactose and/or sucrose.
- An alkaline/alkaline (red slant, red butt) reaction: Absence of carbohydrate fermentation results.
- Blackening of the medium: Occurs in the presence of H<sub>2</sub>
- Gas production: Bubbles or cracks in the agar indicate the production of gas (formation of CO<sub>2</sub> and H<sub>2</sub>)
- An alkaline/acid (red slant/yellow butt) reaction: It is indicative of dextrose fermentation.



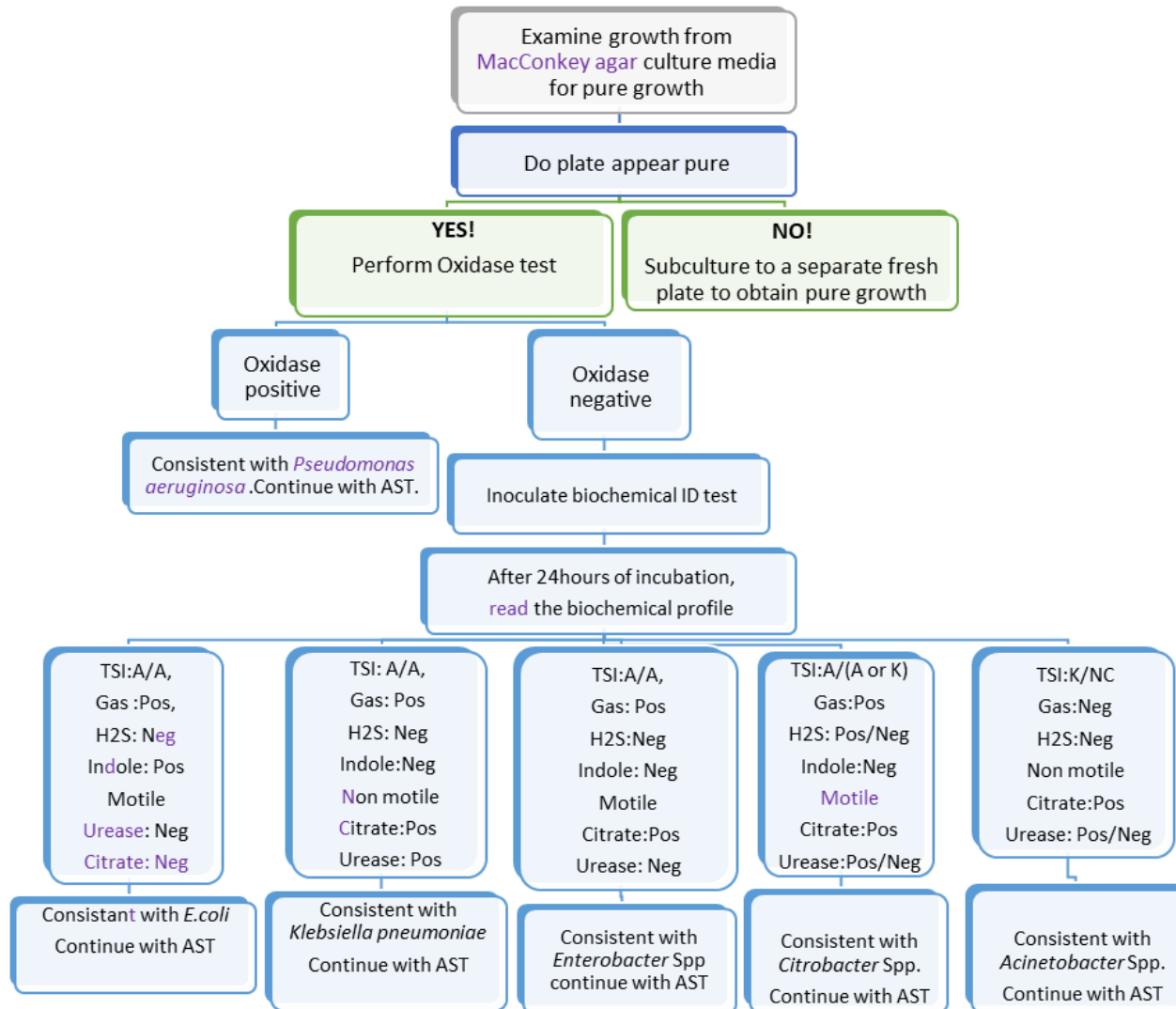

Figure 3: Identification of gram negative Enterobacteriaceae flow chart



### **7.27.16      *Limitation of the Procedure and Sources of Error***

- a) It is recommended that biochemical, immunological, molecular, or mass spectrometry testing be performed on colonies from pure culture for complete identification.
- b) It is important to stab the butt of the medium. Failure to stab the butt invalidates this test. The integrity of the agar must be maintained when stabbing. Caps must be loosened during this test or erroneous results will occur.
- c) TSI Agar must be read within the 18-24 hour stated incubation period. A false-positive reaction may be observed if read too early. A false-negative reaction may be observed if read later than 24 hours.
- d) An organism that produces hydrogen sulfide may mask acid production in the butt of the medium. However, hydrogen sulfide production requires an acid environment, thus the butt portion should be considered acid.
- e) TSI is not as sensitive in detecting hydrogen sulfide in comparison to other iron containing mediums, such as Sulfide Indole Motility (SIM) Medium.
- f) Certain species or strains may give delayed reactions or completely fail to ferment the carbohydrate in the stated manner.

### **7.27.17      *Performance Characteristics***

Refer manufacturer performance characteristics compares to laboratory method verification report

### **7.27.18      *Supporting Documents***

- Laboratory quality policy manual
- Laboratory safety policy manual
- Laboratory sample collection manual

### **7.27.19      *References***

- a) Murray PA, et al. Manual of Clinical Microbiology, 8<sup>th</sup> Edition, 2003, p 355
- b) Murray PA, et al. Manual of Clinical Microbiology, 8<sup>th</sup> ed., 2003, pp 411-412
- c) Murray PA, et al. Manual of Clinical Microbiology, 8<sup>th</sup> ed., 2003, pp 409- 410
- d) Murray PA, et al. Manual of Clinical Microbiology, 8<sup>th</sup> ed., 2003, p 438.
- e) Difco and BBL Manual for Microbiological Culture Media. Maryland, U.S.A., Becton, Dickinson and Company. 2003.
- f) Clinical Microbiology Procedure Handbook, Volume 1, 3<sup>rd</sup> Edition, 2000
- g) L.M. de Laza et al., Color Atlas of Medical Bacteriology, ASM Press, 2004
- h) Cheesbrough, M. District Laboratory Practice in Tropical Countries, 2<sup>nd</sup> Edition, Tropical Health Technology, 2006, p163.
- i) Procedure for the use of API Strips. Whittington Hospital SOP MB/040.04 (2005).
- j) <https://biologypractical.com/tsi-triple-sugar-iron-test-objectiveprinciple-procedure-and-result/>

## **7.28 GERM TUBE TEST**

### **7.28.1 Purpose**

This procedure provides instructions for performing a germ tube test

### **7.28.2 Scope**

This procedure applies to all candida species isolated that need to be confirmed as *Candida albicans*

### **7.28.3 Responsibility**

Trained and competent medical laboratory scientist/technologist is responsible in implementing this procedure

### **7.28.4 Principle**

Candidiasis is a common endogenous opportunistic yeast infection. Of the causative agents, the most common species is *Candida albicans*. The Germ tube test provides one of the most rapid approaches to the presumptive identification of *C. albicans*. Strains of *C. albicans* produce germ tubes from their yeast cells when placed in liquid nutrient environment and incubated at 35°C for 3 hours.

### **7.28.5 Sample Requirements**

24-48-hour old growth of yeast isolate. Sabouraud (SAB) is the best medium to isolate yeast for germ tube production. Sheep blood agar is an acceptable substitute.

### **7.28.6 Equipment**

Incubator, Refrigerator and Microscope

### **7.28.7 Materials**

Pooled human sera that is negative for hepatitis and HIV and free of antifungal agents. Fetal bovine serum, rabbit serum, and other animal sera are also commonly utilized. Aliquot 0.5 ml in 12 x 75mm sterile, disposable tubes. These may be kept in a -20°C freezer. Thaw and allow the tubes to come to room temperature before use.

Microscope slides, coverslips, sterile transfer pipettes, sterile inoculating loop

### **7.28.8 Storage and Stability**

Fetal bovine serum, rabbit serum, and other animal sera Aliquots of 0.5 ml in 12 x 75mm sterile, disposable tubes should be kept in a -20°C freezer. Thaw and allow the tubes to come to room temperature before use.

### **7.28.9 Safety**

Adhere to safety precautions as stated in the Safety manual

All personal protective equipment (PPE) must be worn when performing this procedure.

All samples must be regarded as potentially infectious.

Avoid any contact between hands and eyes and nose during sample collection and testing.

#### **7.28.10 Calibration**

- Not Applicable

#### **7.28.11 Quality Control**

Ensure that all media and supplies used have passed the required Quality control and are used within their expiry date.

Perform Quality control on each batch of sera

#### **7.28.12 Procedural Steps**

- i. Lightly touch a well-isolated colony with a sterile inoculating loop.
- ii. Suspend the yeast cell in 0.5 ml serum/plasma.
- iii. Note: A heavy inoculum of yeast and the presence of bacteria from a mixed culture can each lead to false-negative results.
- iv. Incubate at 35 °C for up to 3 hours. Yeast will begin to germinate at this time.
- v. Note: On prolonged incubation, non-albicans *Candida* spp. may show germ tube production.
- vi. Place a drop of suspension on a microscope slide.
- vii. Place a coverslip over the suspension.
- viii. Examine under high power for the presence of germ tube.
- ix. Very few cells should be seen per microscopic field when results are read.

#### **7.28.13 Biological Reference Intervals**

- Not Applicable

#### **7.28.14 Interpretation and Reporting of Results**

A *germ tube* appears as a short lateral extension from the yeast cell and does not have any constriction (septum) where it meets the yeast cell. The new cellular material that composes a germ tube represents true hyphae that, by definition, do not show points of constriction.

If the filaments are constricted and septate at their points of origin, they are pseudohyphae, not germ tubes.

Both constricted and no constricted filaments may be seen in the germ tube test for *C. albicans*.

It should be noted that some *C. tropicalis* isolates produce pseudohyphae, and some also produce germ tubes that require careful observation to discriminate from those of *C. albicans*. A good rule is to see at least five germ tubes before calling an organism positive, as rare tubes may be produced by other species.

If the preparation appears to contain only constricted germ tubes, one should seriously consider the possibility of *C. tropicalis* or other *Candida* species. When the differentiation may be clinically significant, carbohydrate assimilation studies (e.g., API 20C AUX) may be considered.

Germ tube positive: Report as “*Candida albicans*”

Germ tube negative: Report as “Yeast, not *Candida albicans*”

For germ tube negative yeasts: Set-up supplemental tests when full identification may be clinically significant (e.g., yeast isolates from normally sterile sites).

Examine the wet mount microscopically at 40X for production of germ tubes (long tube-like projections extending out from the yeast cells).

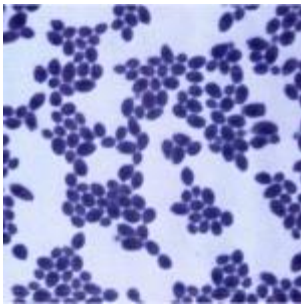

*Candida albicans* in Gram Staining (at 100x) *Candida albicans*: Germ Tube (at

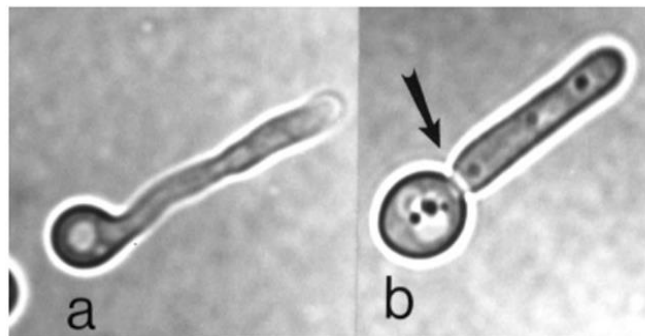

40x) Positive

© Copyright ASM Press, All rights reserved.

#### Figure 4: Germ Test for *Candida albicans*

Germ tube test is a presumptive test. Results obtained with a presumptive test must be consistent with other information regarding the yeast (e.g., colony and cell morphology) and the clinical sample from which the yeast was isolated.

Frequently, isolates of *C. albicans* produce colonies as “yeasts with feet” in recognition of a peripheral fringe. This occurs most frequently on serum-enriched media, such as sheep blood agar.

*Characteristic of Candida albicans:*

**Culture (SDA):** Colonies are white to cream coloured, smooth, glabrous and yeast-like in appearance.

*Microscopic morphology:* Spherical to sub spherical budding yeast cells or blastoconidia, 2.0-7.0 x 3.0-8.5 um in size.

**Plate Culture on Cornmeal and Tween 80 Agar:** Pseudohyphae with blastoconidia and terminal vesicles (chlamydoconidia).

*Germ Tube test:* Positive within 3 hours

*Hydrolysis of Urea:* Negative

*Growth on Cycloheximide medium:* Positive

*Growth at 37C:* Positive

*Candida dubliniensis* is also positive for germ tube production and colonial (on SDA) and microscopic morphology of this organisms is indistinguishable from *C. albicans*; however, *C. dubliniensis* have unusual carbohydrate assimilation patterns and grow poorly or not at all at 42. *C. dubliniensis* has been recognised from the oral cavity of HIV-infected patients and are most frequently implicated in cases of recurrent infection following antifungal drug treatment. Laboratorians should be mindful that *C. dubliniensis* may be obtained from blood, urine, vaginal, and other samples, especially when the patient is immunocompromised or appears refractory to azole treatment

#### **7.28.15      *Limitation of the Procedure and Sources of Errors***

Germ tube test is specific for *candida ablicans* may not detect other candida species or fungal infection

False Negative

Time consuming

Not for susceptibility test

#### **7.28.16      *Performance Characteristics***

Refer to method verification report

#### **7.28.17      *Supporting Documents***

Sample collection manual

### **7.28.18      *References***

Clinical Microbiology Procedures Handbook. American Society for Microbiology. Washington D.C., USA, 2<sup>nd</sup> edition, 2007.

1. Monica cheesbrough (2005). District Laboratory Practice in Tropical countries. Cambridge University Press, New York, USA, 2<sup>nd</sup> edition, 2005.
2. WHO, (2003). Mannual of basic techniques for a health laboratory. Geneva. 2<sup>nd</sup> edition, 2003.
3. Manual of Clinical Microbiology. American Society for Microbiology (ASM), Washington D.C., USA. 9<sup>th</sup> edition, 2007.
4. Manual for the Laboratory Identification and Antimicrobial Susceptibility Testing of Bacterial Pathogens of Public Health Importance in the Developing World. U.S. Centers for Disease Control and Prevention (CDC), Atlanta, Georgia, U.S.A, and World Health Organization (WHO) Geneva Switzerland. 2003
5. International Union against Tuberculosis and Lung Disease. The Public Health Service National Tuberculosis Reference Laboratory and the National Laboratory Network. Paris; 1998.
6. Clinical Microbiology Procedure Handbook, ASM Press 2010. 1752 N. St., N.W.Washington DC 200336-2904, USA.
7. World Health Organization. Laboratory services in tuberculosis. Part II: Microscopy. Geneva; 1998.
8. Larone, D.H. Medically Important Fungi. A Guide to Identification. 5<sup>th</sup> edition. American Society for Microbiology. Washington DC, USA. 2011



## **7.29 ANALYTICAL PROFILE INDEX (API 20E)**

### **7.29.1 Purpose**

This procedure provides instructions for performing analytical profile index (API 20E) test for biochemical differentiation of members of Enterobacteriaceae.

### **7.29.2 Scope**

This procedure provides instructions for performing API 20E test in the Microbiology Laboratory department.

### **7.29.3 Responsibility**

Competent Health Laboratory Practitioners are responsible for implementing this test procedure.

The Head of Unit Microbiology is responsible for ensuring the effective implementation and maintenance of this procedure.

### **7.29.4 Principle**

API test strips consists of micro tubes (cupules) containing dehydrated substrates to detect the enzymatic activity or the assimilation / fermentation of sugars by the inoculated organisms. During incubation, metabolism produces colour changes that are either spontaneous or revealed by the addition of reagents. When the carbohydrates are fermented, the pH within the cupule changes and is shown by an indicator. Assimilation tests are inoculated with a minimal medium (API AUX medium) and the bacteria grow if they are able to utilize the corresponding substrate.

### **7.29.5 Sample Requirements**

Fresh growth of single isolated colonies 18-24 hours of incubation from primary culture media such as blood agar, chocolate agar, nutrient agar or MCA.

### **7.29.6 Equipment**

Incubator, Biological Safety Cabinet, and Microscope

### **7.29.7 Materials**

Reagents

- API 20E strips - store at 2-8°C
- 0.85% sterile saline

Consumables

- Sterile plastic Pasteur pipettes
- Straight inoculating needle

- Oil immersion
- Clean filter paper
- Microscope slide
- Applicator stick

#### **7.29.8 Storage and Stability**

Analytical Profile Index (API20E) strips should be stored as per manufacture's guide/ instructions.

#### **7.29.9 Safety**

- Adhere to safety precautions as stated in the Safety manual
- All personal protective equipment (PPE) must be worn when performing this procedure.
- All samples must be regarded as potentially infectious.
- Refer to National infection prevention and control Guidelines for health waste management and safety practice.
- Avoid any contact between hands and eyes and nose during sample collection and testing.
- Do not use kit beyond the expiration date which appears on the package label or device in a damaged pouch.

#### **7.29.10 Calibration**

All auxiliary equipment should be calibrated annually

#### **7.29.11 Quality Control**

Use known standard organism for positive and negative control (E. coli ATCC 25922, Pseudomonas aeruginosa ATCC 27853).

#### **7.29.12 Procedural Steps**

##### **Preparation of Inoculum**

- Add 5 ml. of 0.85% saline to a sterile test tube.
- Using a sterile inoculating loop, carefully pick the centre of a well-isolated colony and thoroughly emulsify in the saline.

##### **Preparation of the Strip**

- An incubation tray and lid is supplied for each strip.
- Dispense 5 ml of water into the tray.

##### **Inoculation of the Strip**

- Remove the cap from the tube containing the bacterial suspension and fill both the tube and cupule section of [CIT], [VP] and [GEL] tubes using sterile transfer pipette.
- Completely fill the tubes section of the ADH, LDC, ODC, H<sub>2</sub>S and URE tube and seal with mineral oil to create anaerobic condition.
- Inoculate on non-selective media for purity plate, oxidase and serological test and incubate for 18-24hours at 35°C

**Note:** The ADH, LDC, ODC, H<sub>2</sub>S, AND URE reactions can be interpreted best if these micro tubes are slightly under filled.

### Incubation of the Strip

- After inoculation, place the plastic lid on the tray and incubate the strip for 18-24 hours at 35°C in a non-CO<sub>2</sub> incubator.

### Reading the Strip

- After 18 hours of incubation and before 24 hours of incubation, record all reactions not requiring the addition of reagents.
- A positive result is indicated by growth. Test results are entered into an online database to determine the bacterial identity.
- If the GLU tube is negative (blue or green), do not add reagents. Re-incubate a further 18-24 hours.
- If the GLU is positive (yellow):
- Perform the oxidase test. (*Refer procedure for oxidase test*)

**Note:** Before addition of reagents, observe GLU tube (positive or negative) for bubbles.

- The nitrate reduction and indole tests must be performed last since these reactions release gaseous products, which interfere with the interpretation of other tests on the strip. The plastic incubation lid should not be replaced after the addition of these reagents.
- Add the reagents to TDA and VP tubes. If positive, the TDA reactions will be immediate, whereas the VP reaction may be delayed up to 10 minutes.
- The Kovacs' reagent should then be added to the IND tube.
- The Nitrate Reduction test should be performed on all oxidase positive organisms. The reagents should be added to the GLU tube after the Kovacs Reagent has been added to the IND tube.

#### 7.29.13 **Biological Reference Intervals**

- Not applicable

#### *Critical value*

- Not applicable

#### 7.29.14 **Interpretation and Reporting of Results**

- Record results on an API20E analytical profile sheet.
- The tests are separated into groups of three.

The following numerical value is assigned to each reaction recorded:

- Positive reaction in the first test of the group
- Positive reaction in the second test of the group
- 4 - positive reaction in any test
- Negative reaction in any test

**Note: The biochemical reactions of the API 20E should be read after 18-24 hours of incubation. If the strips cannot be read after 24 hours of incubation at 35°C or 37°C, the strips should be removed from the incubator and stored at 2-8°C (refrigerator) until the reactions can be read.**

#### API 20 E after incubation...Positive results for all tests :



 Microbiology Info.com

#### API 20 E after incubation...Negative results for all tests :



**Figure 5: API Positive and Negative Test Results**

#### 7.29.15 Limitation of the Procedure and Sources of Errors

- I. Nichrome wire loops can cause false positive results to some biochemical test.
- II. Media containing glucose or dyes (e.g. MAC) or TCBS can cause false positive results
- III. Timing is critical to accurate testing.
- IV. An H<sub>2</sub>S producing organism may exhibit blackening on SIM medium, but none on TSI medium
- V. Many bacteria are motile at one temperature and non-motile when at another.
- VI. Some organisms may split urea slowly.
- VII. Urea is light sensitive and can undergo auto hydrolysis. Store at 2-8°C.
- VIII. Interpret the reaction in combination with other identification tests for Enterobacteriaceae

#### 7.29.16 Performance Characteristics

Refer to the laboratory method verification procedure and report

### **7.29.17      *Supporting Documents***

- Laboratory quality policy manual
- Laboratory safety policy manual
- Laboratory sample collection manual

### **7.29.18      *References***

1. Murray PA, et al. Manual of Clinical Microbiology, 8th Edition, 2003, p 355
2. Murray PA, et al. Manual of Clinical Microbiology, 8th ed., 2003, pp 411-412
3. Murray PA, et al. Manual of Clinical Microbiology, 8th ed., 2003, pp 409-410
4. Murray PA, et al. Manual of Clinical Microbiology, 8th ed., 2003, p 438.

## 7.30 ANTIBIOTIC SUSCEPTIBILITY TESTING BY KIRBY BAUER DISK DIFFUSION METHOD

### 7.30.1 Purpose

This provides guidance on how to perform in-vitro susceptibility testing of bacteria pathogens to antimicrobial agents by disc diffusion (Kirby Bauer method) according to Clinical and Laboratory Standards Institute (CLSI) guideline.

### 7.30.2 Scope

This procedure applies to all antibiotic susceptibility testing in the bacteriology section using CLSI guideline

### 7.30.3 Responsibility

The Health Laboratory Scientists/ Technologists in Microbiology section are responsible for the implementation of this procedure.

Section heads are responsible in reviewing AST results produced in the laboratory before submitting to clinicians for patient management.

### 7.30.4 Principle

This procedure describes the standard technique used to determine the in-vitro susceptibility of aerobic non-fastidious organisms. Antimicrobial susceptibility testing (AST) should only be performed with pathogens for which well-standardized methods are available and pathogens whose resistance is known or suspected to be a clinical problem; AST should not be performed on normal flora or colonizing organisms.

Kirby Bauer (KB) is a standardized procedure for performing AST by disk diffusion. A standardized inoculum of the bacteria is swabbed onto the surface of a Mueller Hinton agar (MHA) plate. Filter paper disks impregnated with antimicrobial agents are placed on the agar. After overnight incubation, the diameter of the zone of inhibition around each disk is measured. By referring to the standardized tables compiled by CLSI, a qualitative report of susceptible, intermediate or resistant can be obtained.

### 7.30.5 Sample Requirements

Pure culture of the organisms from an 18-24-hour agar plate, preferably a nonselective medium like sheep blood agar.

### 7.30.6 Equipment

Incubator, Refrigerator, Candle jars

### 7.30.7 Materials

Reagent	Consumables
Mueller- Hinton agar	Sterile glass tubes
<i>Haemophilus</i> Test Medium	Sterile pasteur pipettes
(HTM)/Chocolate agar	Sterile swabs
GC media	Zone criteria chart
Mueller Hinton/ Mueller Hinton with 5%sheep blood agar	Vernier caliper or transparent ruler
	Forceps

Antibiotic discs (stored frozen with descants) 0.5 McFarland turbidity standard Sterile normal saline	Control organisms (ATCC control strains)
---	--

### **7.30.8 Storage and Stability**

Store the McFarland standard at room temperature (25°C) when not in use. McFarland standard density solution will precipitate and clump over time, and it needs vigorous vortexing before each use.

Prepare a fresh standard solution every 6 months.

### **7.30.9 Safety**

Decontaminate working surfaces as recommended by IPC Guidelines

Adhere to safety precautions as stated in the Safety manual

All personal protective equipment (PPE) must be worn when performing this procedure.

All samples must be regarded as potentially infections.

Avoid any contact between hands and eyes and nose during sample collection and testing.

All spills should be wiped thoroughly using 1% sodium hypochlorite solution.

### **7.30.10 Calibration**

Not Applicable

### **7.30.11 Quality Control**

Bacteria isolate's sensitivity test results are only reported when appropriate ATCC control strains results fall within the interpretive criteria as defined in CLSI guideline. Include appropriate control organism with each test to monitor overall performance of the test system.

Test control strains should be set the same way using the same conditions and methods that are used to test clinical isolates and records it on appropriate quality control log  
AST quality control can be performed in weekly basis or when testing a patient sample

### **7.30.12 Procedural Steps**

Bring agar plates and antibiotic disks to room temperature before use.

Prepare bacterial suspension.

- a. The direct colony suspension method is the most convenient method for inoculum preparation. This method can be used for most organisms. Select 3 – 5 well-isolated colonies of the same morphologic type from an agar plate culture. Touch the top of each colony with a loop and transfer the growth into a tube containing 4 – 5ml of TSB or NSS. Mix well and adjust turbidity with broth or NSS to match 0.5 McFarland standard.
- b. The Growth method can be used alternatively and is sometimes preferable when colony growth is difficult to suspend directly and a smooth suspension cannot be made. It can be used for nonfastidious organisms (except

Staphylococci) when fresh 24 hour colonies are not available. Select 3 – 5 well-isolated colonies of the same morphologic type from an agar plate culture. Touch the top of each colony with a loop and transfer the growth into a tube containing 4 – 5 ml of TSB. Incubate the broth culture at  $35 \pm 2^\circ\text{C}$  until it achieves or exceeds the turbidity of the 0.5 McFarland standard (usually two to six hours). Mix well and adjust turbidity with TSB to match 0.5 McFarland standard.

#### Inoculate plate with bacterial suspension

- a. Within 15 minutes of adjusting turbidity, dip a sterile cotton tipped applicator swab into the inoculum and rotate against the wall of the tube to remove excess inoculum.
- b. Swab entire surface of the agar plate three times, rotating plate approximately  $60^\circ$  between streaking to ensure even distribution. As a final step, swab the rim of the agar.
- c. Allow inoculated plate to stand 3 -15 minutes (no longer than 15 minutes) before applying disks.
- d. Apply antibiotic disks to agar surface using sterile forceps or dispenser. Apply gentle pressure to ensure complete contact of disk with agar.
- e. Do not relocate a disk once it has made contact with agar surface. Instead, place a new disk in another location on the agar.
- f. Place no more than 12 disks on 150 mm plate and no more than 5 disks on 100 mm plate.
- g. The working supply of antibiotic disks should be stored in a refrigerator ( $2 - 8^\circ\text{C}$ ) in a tightly-capped container with desiccant. Upon removal of the disks from the refrigerator, the package containing the cartridges should be left unopened at room temperature for approximately one hour to allow the temperature to equilibrate; this reduces the amount of condensation on the disks. If a disk dispenser is used, it should have a tight-fitting cover, be stored in the refrigerator, and be allowed to warm to room temperature before use.
- h. Invert plate and incubate within 15 minutes of disk application. Incubate for 16 – 18 hours at  $35 \pm 2^\circ\text{C}$  in an ambient air incubator

#### **Inoculum preparation and plating**

- a. Select the colonies of interest from pure bacterial culture after 16-18hrs of incubation
- b. Emulsify colonies in 4-5ml sterile saline to make a bacterial suspension.
- c. Adjust the suspension to 0.5 McFarland standards.
- d. Dip a sterile swab into the suspension and rotate several times.
- e. Press the swab firmly against the inside walls of the tube/bottle just above the fluid level and rotate the swab to remove the excess liquid.
- f. Streak the entire surface of the medium three times, rotating the plate approximately through  $60^\circ$  after each application to ensure a distribution of inoculums.



- g. Bring the disc at room temperature and apply antimicrobial discs on to the plate as soon as possible (not longer than 15 minutes after inoculation).
- h. Discs should be evenly spaced 20mm away from each other.
- i. Each plate should carry a maximum of 6 disks for 100×15mm plate
- j. Incubate the plate at 35°C±2°C for 16 – 18 hours in ambient air incubator and in CO2 incubator for fastidious bacteria
- k. Measure the zone diameter of complete inhibition in mm using a transparent ruler or vernier caliper
- l. Interpret the zone measurement according to CLSI break points.

**7.30.13 Biological Reference Intervals**

Not Applicable

**7.30.14 Interpretation and Reporting of Results**

- a. Read plates only if lawn of growth is confluent. If individual colonies are apparent the inoculum was too light and the test must be repeated
  - b. Hold inverted plate a few inches above a black nonreflecting surface, illuminate plate with reflected light
  - c. Use ruler held on the back of the plate to measure the diameter of zone of inhibition (area showing no obvious growth to the naked eyes)
  - d. Measure the zone size to the nearest millimeter (mm)
  - e. Based on the **CLSI guideline** AST are Interpreted as **Resistant, Intermediate or Susceptible** according to the zone sizes reading in millimeter.
- The following tables should be referred when selecting and interpreting Antimicrobial sensitivity testing;
    - a. Selection of antimicrobial agents (
    - b. Interpretation of Quality control results to monitor accuracy of disc diffusion method
    - c. Interpretive categories and zone diameter breakpoints of different bacterial group nearest whole mm

**AST Interpretation and Reporting of Results to clinician**

- a. Facility will record antibiotics zone sizes in millimeter (mm) according to the updated CLSI guideline to the working sheet and report to clinician/requester as Resistant, Intermediate or Susceptible (R, I, S).
- b. Reporting of antibiotics will be based on selectivity in categories established by updated CLSI guideline i.e., test all group categories A, B, C and U and selectively report group A, if all antibiotics in Group A are resistant, report the rest of the groups

**Table: Interpretive categories and zone diameter breakpoints of different bacterial group nearest whole mm by Organism and site/sample (CLSI guidelines 2019)**

<i>Staphylococcus spp</i>	R (mm)	I (mm)	S (mm)
Group A			

Erythromycin 15 µg	< 13	14-22	> 23
Clindamycin 2 µg	≤14	15-20	≥21
<p>Cefoxitin 30 ug (surrogate test for oxacillin):  <i>Use CEFOXITIN disk to test for OXACILLIN resistance.</i>  <i>For S. aureus and S. lugdunensis:</i>  <i>Incubate plates at 33-35°C ambient air for 16-18 hours.</i>  ≤ 21mm = mec A positive → report as OXACILLIN RESISTANT (do not report Cefoxitin)  ≥ 22mm = mec A negative → report as OXACILLIN SENSITIVE (do not report Cefoxitin)</p> <p><i>For epidermidis:</i>  <i>Incubate at 33-35°C ambient air for 24 hours; may be reported after 18 hours if resistant.</i>  ≤ 24mm = mec A positive → report as OXACILLIN RESISTANT (do not report Cefoxitin)  ≥ 25mm = mec A negative → report as OXACILLIN SENSITIVE (do not report Cefoxitin)</p>			
Trimethoprim Sulfa 1.25/23.75 µg	≤10	11-15	≥16
<b>Group B</b>			
Tetracycline 30 ug	≤14	15-18	≥19
<p><i>Vancomycin 30 ug ***Vancomycin susceptibility is done using an MIC method: strains with MIC's: ≤ 2µg/ml = Sensitive, 4-82µg/ml = Intermediate, and ≥16 2µg/ml = Resistant</i></p>			
<b>GROUP C</b>			
Chloramphenicol 30 ug	≤12	13-17	≥18
Ciprofloxacin 5ug	≤15	16-20	≥21
Gentamicin 10 ug	≤12	13-14	≥15
<b>Group U</b>			
Nitrofurantoin 300 ug [for urinary isolates only]	≤14	15-16	≥17
<b>Enterococcus spp</b>	<b>R(mm)</b>	<b>I(mm)</b>	<b>S(mm)</b>
<b>GROUP A:</b>			
Penicillin 10 units	≤14	–	≥15
Ampicillin 10 ug	≤16	–	≥17
<b>Group B:</b>			
Vancomycin 30 ug (incubate for 24 hours!)	≤14	15-16	≥17
<b>Group C</b>			
Gentamicin 120 µg (do not use CN 10ug) *	≤6	7-9	≥10
<b>Testing with Gentamicin 120 µg disk:</b>			

<p>6mm = resistant → report GM as <b>not synergistic</b> with Ampicillin, Penicillin, or Vancomycin</p> <p>7-9mm = inconclusive → confirm with MIC</p> <p>≥ 10mm = susceptible → report GM is synergistic with Ampicillin or Vancomycin that is also susceptible. Combination therapy with Ampicillin, Penicillin, or Vancomycin (for susceptible strains) plus an aminoglycoside (Gentamicin or Streptomycin) is usually indicated for serious enterococcal infections such as bacteraemia and endocarditis, unless high level resistance for both Gentamicin and Streptomycin is documented; such combinations are predicted to result in synergistic killing of <i>Enterococcus</i>.</p>			
Chloramphenicol 30ug (not routinely reported for isolates from urinary tract )	≤12	13-17	≥18
<b>Group U</b>			
Ciprofloxacin 5 ug	≤15	16-20	≥21
Levofloxacin	≤12	13-16	≥17
Tetracycline 30ug	≤14	15-18	≥19
Nitrofurantoin 300 ug (for urine isolates only )	≤14	15-16	≥17
<b><i>Streptococcus pneumoniae</i></b>	<b>R</b>	<b>I</b>	<b>S</b>
<b>Group A</b>			
Penicillin (as defined by Oxacillin 1ug) Isolates with oxacillin zone ≥20 are susceptible to Penicillin			≥20
Vancomycin 30µg	–	–	≥17
Erythromycin 15ug	≤15	1	≥21
Trimethoprim Sulfa 1.25/23.75 µg	≤15	16-20	≥19
<b>Group B</b>			
Tetracycline 30 ug	≤24	25-27	≥28
Clindamycin 2µg	≤15	16-18	≥19
<b>Group C</b>			
Chloramphenicol 30 ug	≤20	–	≥21

<b>Streptococcus spp β-haemolytic</b> Perform AST on MHA + Blood (“red Mueller Hinton”)	<b>R</b>	<b>I</b>	<b>S</b>
<b>GROUP A</b>			
Penicillin 10 units	–	–	≥24
Erythromycin 15 ug	≤15	16-20	≥21
Clindamycin 2 ug	≤15	16-18	≥19
<b>Group B</b>			
Cefotaxime 30ug or	–	–	≥24
Ceftriaxone 30µg or	–	–	≥24
Vancomycin 30 ug	–	–	≥17
<b>Group C</b>			
Chloramphenicol 30ug	≤17	18-20	≥21
Levofloxacin 5 µg	≤13	14-16	≥17
<b>GROUP O</b>			
Tetracycline 30 µg	≤18	19-22	≥23
<i>Note: * Penicillin and ampicillin are drugs of choice for treatment of β-haemolytic Streptococcal infections; <b>susceptibility testing need not be performed routinely</b> because non-susceptible isolates are extremely rare in any β-haemolytic streptococcus</i>			
<b>Enterobacteriaceae (Salmonella spp has unique breakpoints described below)</b>	<b>R</b>	<b>I</b>	<b>S</b>
<b>GROUP A</b>			
Ampicillin 10 ug	≤13	14-16	≥17
Cefazolin 30 ug	≤19	20-22	≥23
Gentamicin 10g	≤12	13-14	≥15
<b>GROUP B</b>			
Piperacillin 100ug	≤17	18-20	≥21
Amoxicillin/Clavulanic Acid 20/10 ug	≤13	14-17	≥18
Piperacillin/Tazobactam 100/10 ug	≤17	18-20	≥21
Cefepime 30 ug	≤18		≥25
Cefotaxime 30 ug or	≤22	23-25	≥26
Ceftriaxone 30 ug	≤19	20-22	≥23
Cefuroxime 30 ug	≤14	20-22	≥23
Amikacin 30 ug	≤14	15-16	≥17
Ciprofloxacin 5 ug	≤21	22-25	≥26
Trimethoprim Sulfa 1.25/23.75 ug	≤10	11-15	≥16
Imipenem	≤19	20-22	≥23
<b>GROUP C</b>			
Ceftazidime 30 ug	≤17	18-20	≥21
Tetracycline 30 ug	≤11	12-14	≥15

Chloramphenicol 30 ug	≤12	13-17	≥18
<b>GROUP U</b>			
<i>Nitrofurantoin 300 ug</i> (for urinary tract isolates only)	≤14	15-16	≥17
<b><i>Acinetobacter spp.</i></b>	<b>R</b>	<b>I</b>	<b>S</b>
<b>GROUP A</b>			
Ceftazidime 30µg	≤14	15-17	≥18
Ciprofloxacin 5µg	≤15	16-20	≥21
Levofloxacin 5 µg	≤13	14-16	≥17
Imipenem 10µg	≤18	19-21	≥22
Meropenem 10µg	≤14	15-17	≥18
Gentamicin 10µg	≤12	13-14	≥15
Tobramycin 10µg	≤12	13-14	≥15
<b>GROUP B</b>			
Piperacillin-Tazobactam 100/10µg	≤17	18-20	≥21
Cefepime 30 µg	≤14	15-17	≥18
Cefotaxime 30µg	≤14	15-22	≥23
Ceftriaxone 30µg	≤13	14-20	≥21
Trimethoprim-sulfamethoxazole 1.25/23.75µg	≤10	11-15	≥16
Amikacin 30µg	≤14	15-16	≥17
<b>GROUP U</b>			
Tetracycline 30µg	≤11	12-14	≥15
<b><i>Pseudomonas spp</i></b>	<b>R</b>	<b>I</b>	<b>S</b>
<b>GROUP A</b>			
Piperacillin 100 ug	≤14	15-20	≥21
Ceftazidime 30ug	≤14	15-17	≥18
Gentamicin 10 ug	≤12	13-14	≥15
<b>GROUP B</b>			
Piperacillin-Tazobactam 100/10 ug	≤14	15-20	≥21
Cefepime 30 ug	≤14	15-17	≥18
Imipenem 10 ug	≤15	16-18	≥19
Amikacin 30 ug	≤14	15-16	≥17
Ciprofloxacin 5 ug	≤18	19-24	≥25
<b>GROUP U</b>			
Norfloxacin 10 ug	≤12	13-16	≥17
<b><i>Enteric pathogen: Salmonella spp and Shigella spp</i></b>	<b>R</b>	<b>I</b>	<b>S</b>

For Stool isolates from infants or immune-compromised hosts only: Report AMP, CIP, and TRIMETH-SULFA.

For Salmonella in blood and other extra-intestinal sites:

Report AMP, CIP, and TRIMETH-SULFA.

In addition, test and report CEFOTAXIME and CHLORAMPHENICOL.

Test for resistance to NALIDIXIC ACID.

For isolates that test susceptible to CIP and resistant to nalidixic acid, the physician should be informed that the isolate may not be eradicated by fluoroquinolone treatment

Ampicillin 10 ug	≤13	14-16	≥17
Azithromycin 15ug	≤12	-	≥13
Ciprofloxacin 5 ug	≤20	21-30	≥31
Trimethoprim/Sulfamethoxazole 1.25/23.75µg	≤10	11-15	≥16
Chloramphenicol 30 µg (if salmonella isolated from other samples but stool)	≤12	13-17	≥18
<b>Haemophilus influenza and Haemophilus parainfluenza</b>	<b>R</b>	<b>I</b>	<b>S</b>
<b>GROUP A</b>			
Ampicillin 10ug	≤18	19-21	≥22
<b>GROUP B</b>			
Ceftriaxone 30 ug	–	–	≥26
Ciprofloxacin 5 µg <b>or</b>	–	–	≥21
Meropenem 10 µg	–	–	≥20
<b>GROUP C</b>			
Azithromycin 15 µg	–	–	≥12
Amoxicillin/clavulanate 20/10 µg	≤19	–	≥20
Chloramphenicol 30 µg	≤25	26-28	≥29
Imipenem 10 µg	–	–	≥16
Tetracycline 30 µg	≤25	26-28	≥29
Trimethoprim –sulfamethoxazole 1.25/23.75 µg	≤10	11-15	≥16
<b>Neisseria meningitides</b>	<b>R</b>	<b>I</b>	<b>S</b>
Test and report all. Caution! Perform all AST of <i>N. meningitidis</i> in a biosafety cabinet (BSC). Manipulating suspensions of <i>N. meningitidis</i> outside a BSC is associated with a high risk for contracting meningococcal disease.			
<b>GROUP C</b>			
Ceftriaxone 30 µg	–	–	≥34
Ciprofloxacin 5 µg	≤32	33-34	≥35
Azithromycin 15 µg	–	–	≥20
Cefotaxime 30 ug	–	–	≥34

Meropenem 10 µg	–	–	≥30
Chloramphenicol 30 ug	≤19	20-25	≥26
Trimethoprim/ 1.25/23.75µg Sulfamethoxazole	≤25	26-29	≥30
<b><i>Neisseria gonorrhoea</i></b>	<b>R</b>	<b>I</b>	<b>S</b>
<b>GROUP A</b>			
Ciprofloxacin 5 µg	≤27	28-40	≥41
Tetracycline 30 µg	≤30	31-37	≥38
Ceftriaxone 30 µg	–	–	≥35
<b>GROUP O</b>			
Penicillin 10units	≤26	27-46	≥47
Cefepime 30 µg	–	–	≥31
Cefotaxime 30 µg	–	–	≥31

### **7.30.15 Limitation of the Procedure and Sources of Errors**

Factors affecting agar diffusion method

Purity of colonies

Inoculum size

Excess fluid to culture media

Streaking the plate

Disc potency

Number of discs applied

Incubation time/temperature

Depth and PH of the media

### **7.30.16 Performance Characteristics**

Refer to method verification report

### **7.30.17 Supporting Documents**

Sample collection manual

### **7.30.18 References**

- Performance Standards for Antimicrobial Susceptibility Testing; **M100 30<sup>th</sup> Edition**
- Performance Standards for Anti-Microbial Disc Susceptibility Testing. Approved Standards (2003) 8<sup>th</sup> ed. NCCLS 23 no 1: 1-25
- National Antimicrobial Resistance Surveillance Framework, Tanzania Ministry of Health, August 2018

## **7.31 MANAGEMENT OF BACTERIAL ISOLATES**

### **7.31.1 Purpose**

The procedure describes how to manage clinical and standard bacterial isolates (ATCC strains)

### **7.31.2 Scope**

This procedure applies for storage of bacterial stock isolates from reference organisms, EQA strains and isolates from clinical samples

### **7.31.3 Responsibility**

Trained and competent laboratory Technologist/ Scientist working in microbiology section is responsible for the implementing this procedure.

### **7.31.4 Principle**

To ensure the genetic stability and prevent contamination of culture strains, the number of process must be done from original isolates and standard strains to preserve their viability and identity. Isolates are stored in cryovials containing a cryo-preserved STGG, which is subsequently frozen at -80°C for long term storage (>1year) and at -20°C for short term storage (six month) for fastidious organisms. Isolates from non-fastidious organisms can as well stored using 5% TSB for long and short term. If subculture is required a small amount of frozen bacterial suspension may be scraped from the surface STGG using a loop and inoculated on agar plate.

### **7.31.5 Materials**

Blood Agar, Skim milk powder, Cryogenic vial (2ml) with screw cap, BHI/TSB, Glycerol, Non-selective media, ATCC strains/clinical isolates, Permanent label, Sterile disposable inoculating loop, sterile transfer pipettes, Autoclave control indicator, Dry ice and Disposable petri dishes

### **7.31.6 Equipment**

Autoclave, Weighing balance, -80°C & -20°C freezer, Vortex mixer, Water bath, Incubator and Biological safety cabinet (BSC).

### **7.31.7 Safety**

Decontaminate working surfaces as recommended by IPC Guidelines

Temperatures for the room and refrigerator are recorded as recommended by IPC Guidelines.

Adhere to safety precautions as stated in the Safety manual

All personal protective equipment (PPE) must be worn when performing this procedure.

All samples must be regarded as potentially infections.

Refer to National infection prevention and control Guidelines for health waste management and safety practice.

Avoid any contact between hands and eyes and nose during sample collection and testing.



### **7.31.8 Storage and Stability**

Isolates are stored in cryovials containing a cryo-preservative STGG, which is subsequently frozen at -80°C for long term storage (>1year) and at -20°C for short term storage (six month) for fastidious organisms. Isolates from non-fastidious organisms can as well stored using 5% TSB for long and short term. If subculture is required a small amount of frozen bacterial suspension may be scraped from the surface STGG using a loop and inoculated on agar plate.

### **7.31.9 Calibration**

All auxillary equipment that gives metrological measurements should be calibrated.

### **7.31.10 Quality Control**

#### **Sterility check**

Streak 10 µl onto a BAP or a CAP and incubate for 48 hours at 35-37°C with ~5% CO<sub>2</sub> (or in a candle-jar) to verify the sterility of the solution.

**Acceptable result;** no growth should be observed.

### **7.31.11 Procedure Steps**

#### **Preparation of storage media**

##### **Preparation of 10% skimmed milk Glycerol**

For preparation of 100mls of skimmed milk

- i. Weigh, 10gm of powdered skimmed milk in 90mls of distilled water
- ii. Autoclave the mixture at 121<sup>o</sup> C for 5minutes
- iii. Add 10mls of glycerol into the autoclaved mixture
- iv. Aliquot about 1ml of the sterile skimmed milk solution into plastic tubes or screw cap 2ml Cryovials.

#### **Preparation of Skim milk Tryptone glucose glycerol (STGG) medium**

- i. STGG medium is used for transport and short-term storage of nasopharyngeal swabs.
- ii. Add the following ingredients to 100 ml distilled water: 2 g skim milk powder 3 g TSB 0.5 g glucose 10 ml glycerol
- iii. Mix to completely dissolve all ingredients.
- iv. Dispense 1.0 ml amounts into 1.5 ml screw-cap vials.
- v. Loosen the screw caps and autoclave at 121°C for 10 minutes.
- vi. Tighten the caps after autoclaving and store at -20°C until use.

#### **Preparation of 15% TSB**

- i. Mix 85 ml of Tryptic soy broth with 15 ml of glycerol
- ii. Mix well then pour mixture in a properly labeled reagent bottle.
- iii. Dispense 2 ml of the medium in cryovials using sterile transfer pipette Use autoclave indicator tape to indicate attainment of the required temperature.
- iv. Autoclave the medium at 121°C for 15 minutes.
- v. Before storage and use perform quality control.
- vi. Observe for signs of contamination (turbidity) prior to use and storage.

- vii. Medium may be stored with cry vials tight at 2 to 8°C for up to 6 months

### **Handling and storage Procedure Steps**

#### **Procedure Steps for stock culture of Quality control organisms (ATCC strains)**

- i. Obtain ATCC strains from commercial sources or EQA isolates and document receipt of the isolates
- ii. Working under BSC, subculture the Quality control organisms to the non-selective media (sheep blood agar or chocolate agar), to obtain isolated colonies if the organism is fastidious e.g. *Haemophilus* or *Neisseria* spp, Incubate at 35<sup>0</sup> C for 18-48 hours in 5 -10% CO<sub>2</sub> atmosphere.
- iii. Examine the cultured plates to determine if the Quality control strains are of pure culture and have the characteristics appropriate for the strains (e.g. *S. pyogenes* should be Beta hemolytic)
- iv. Use sterile loop, harvest the entire growth from pure culture plate and dispense into a labelled cryotube containing STGG medium.
- v. Recap vial and label with organism code, ATCC number and date.
- vi. Store vials between – 76 to -85°C. Place vials in the box labeled “Permanent Stocks”.

#### **Proper rotation of the ATCC Quality control Strains.**

- i. Thaw vials of each of the Quality control strains on the first week of the month, and subculture to proper agar plates (BA).
- ii. Transfer a portion of each appropriate strain to new cryovial tube of skim milk and another portion to culture plate and incubate overnight-If good growth is obtained
- iii. Store agar plates for use during this current month.
- iv. The first agar plate can be used for the first week’s Quality control.
- v. On each of the remaining weeks of this month, subculture each strain to appropriate agar plates from the first plate after 72 hours and use these plates for that week’s Quality control.
- vi. At the end of each month discard all plates and start with “freshly” frozen strains again from the cryovial tube of skim milk.
- vii. If using Skim milk as the suspending media for the frozen strains new Cryovials should be prepared at the end of one year.

#### **Procedure Steps for clinical isolates**

- i. Following isolation of bacterial pathogen from clinical sample e.g. isolation of *E. coli* from urine sample
- ii. Subculture the organism on non-selective media (e.g. sheep blood agar, Nutrient agar or chocolate agar). Ensure that the culture is pure; if mixed, pick off a well isolated colony and re-subculture.

- iii. Label the cryotube with permanent marker pen to include name of isolates, unique laboratory identification number and date of isolation or with barcode label.
- iv. Use sterile loop, harvest the entire growth from pure culture plate and dispense into a labelled cryotube containing STGG medium
- v. Immediately store vials at – 76 to -85°C freezer for long terms storage. Arrange vials in numerical order, using freezer vial number as reference.
- vi. Record the details in the isolates logbook and laboratory database repository

### Method for the recovery of the frozen isolate

- i. Remove the appropriate cryotube from the freezer
- ii. Working under BSC, use a sterile plastic loop, inoculate a small amount of frozen material into broth or onto an appropriate solid medium
- iii. Return the tube to the -80°C freezer immediately.

### Packaging and Transportation of isolates

#### a. Triple Packaging

- i. Triple Packaging System to Maintain Cold Chain
- ii. The primary container contains the sample. Ensure the following:
  - a. Container cap should be tightly closed and sealed to prevent leakage.
  - b. Container should be labeled with the patient's name and identification number, source of sample, date and time of collection, and initials of the collector.
  - c. Label should be adhered to the container.

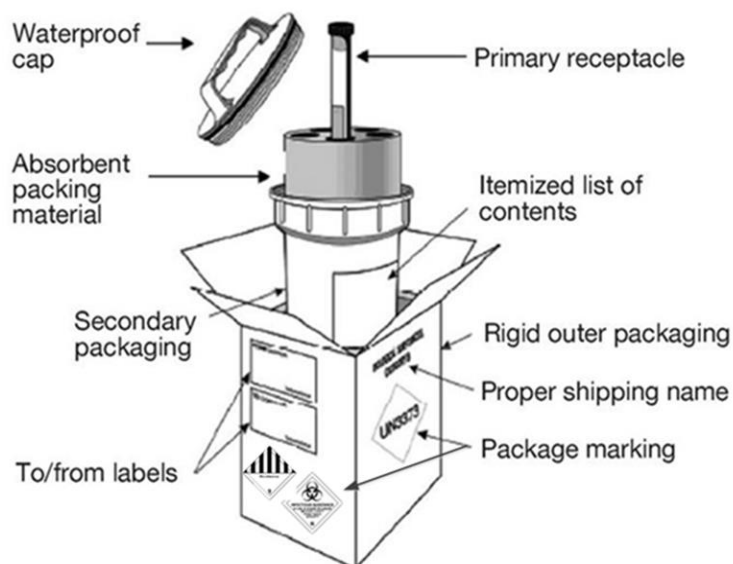

**Figure 6: Illustration of Triple pack**

### Transportation of isolates

**IATA** guidelines will be followed and include labelling the outer packaging of the shipment printed in capital letters or clear writing the following information:

I. **Shipper:** Enter the full name, address and contact number of the person packing the shipment.

II. **Consignee:** Enter the full name, address and contact number of recipients.

#### **7.31.12      *Supporting Documents***

- Laboratory quality policy manual
- Laboratory safety policy manual
- Laboratory sample collection manual

#### **7.31.13      *References***

1. Eiseberge, Henry D 2004. Clinical microbiology procedures handbook, 2<sup>nd</sup> edition American Society for Microbiology.
2. Washington Cheesbrough, Monical 2001, Laboratory Practice in Tropical countries, part 2, Cambridge University Press.UK. Quality control organisms (should be ATCC strains) received from a reliable laboratory on a swab, slant/slope, Petri dish or lypholysed
3. Manual of Clinical Microbiology. American Society for Microbiology (ASM), Washington D.C., USA. 12th edition, 2019.
4. Tanzania AMR Surveillance SOP – Version: 1.0 February 2019

## **7.32 DETECTION OF COMMON BACTERIAL RESISTANCE MECHANISM**

### **7.32.1 Purpose**

This procedure provides guidance on detection of common bacterial resistance mechanisms

### **7.32.2 Scope**

This procedure applies to all common bacterial resistance mechanisms e.g.ESBL, MRSA,VRSA,inducible clindamycin resistance and carbapenems resistance bacteria

### **7.32.3 Responsibility**

Laboratory scientist/ technologist performing antimicrobial susceptibility in the laboratory is responsible to implement the procedure

### **7.32.4 Principle**

Resistance is the inability of antimicrobial agent to kill or inhibit the microorganism with clinically achievable drug concentrations. Resistance can be inherently present in bacteria (intrinsic) or can be acquired. Resistance is dependent on the environmental selection pressures created by antibiotics overuse/abuse and the plasticity of bacterial genomes

Bacteria resist against antimicrobials activity by production of enzymes that can inactivate/degrade antibiotics (e.g. *ESBL production in Enterobacteriaceae*), bacterial DNA mutations and production of alternative proteins which cannot be targeted by antimicrobial agent (e.g. *mec-A gene in MRSA*), possession of efflux pumps which can transport a variety of compounds including antimicrobial agents,decrease permeability of the membrane that surrounds the bacterial cell,and target reprogramming (e.g. *Vancomycin resistance bacteria* )

Laboratory can detect mechanisms of resistance by phenotypic and genotypic methods

### **7.32.5 Sample Requirements**

Fresh isolated organisms from 18-24hours incubated sample

### **7.32.6 Equipment**

Incubator

### **7.32.7 Materials**

Muller hinton agar, 0.5 Mac farland standard, Sterile cotton swab, Sterile pasteur pipettes, Glass tubes, Forceps/needle, Antibiotic discs (Ceftazidime, 30µg, Cefotaxime 30 µg, or ceftriaxone 30µg, Amox/Clav (20/10µg), Cefepime/clavulanic acid 30/10µg, Ceftazidime/clavulanic acid 30/10 µg, Cefotaxime/clavulanic acid 30/10µg, Cefoxitin 30µg,Clindamycin 2 µg, and Erythromycin 15 µg.

### **7.32.8 Storage and stability**

All materials should be stored as per the manufacturers recommendations. Do not use expired items.

### **7.32.9 Safety**

Adhere to safety precautions as stated in the Safety manual

All personal protective equipment (PPE) must be worn when performing this procedure.

All samples must be regarded as potentially infections.

Refer to National infection prevention and control Guidelines for health waste management and safety practice.

Avoid any contact between hands and eyes and nose during sample collection and testing.

Do not use kit beyond the expiration date which appears on the package label or device in a damaged pouch.

All spills should be wiped thoroughly using 1% sodium hypochlorite solution.

### **7.32.10 Calibration**

Not applicable

### **7.32.11 Quality Control**

Use standard control organisms (ATCC strains) e.g.known ESBL (*E.coli*ATCC® 35218 (*TEM-1*  $\beta$ -lactamase (*non* ESBL), *ampicillin* resistant *K.pneumoniae* ATCC 700603),MRSA,VRSA,inducible clindamycin strains and carbapenemes

### **7.32.12 Procedure Steps**

#### **7.32.12.1 Detection of ESBL producing Enterobacteriaceae**

#### **Introduction**

ESBL producing enterobacteriaceae are Gram-negative bacteria that produce an enzyme, beta lactamase that can hydrolyze the third generation cephalosporins and aztreonam.

*E. coli* and *Klebsiella spp.* are common producers of EBSL, and they usually cause urinary tract infections and bacteraemia.

Since ESBLs are inhibited by clavulanic acid, this method compares the zones of inhibition of cephalosporin disc to those of the same cephalosporin plus clavulanic

acid. Infections caused by ESBL producing Enterobacteriaceae are difficult to treat and associated with increased hospital stay, mortality and morbidity.

### Combination disc method-Procedure notes

Prepare a bacterial suspension by using a wire loop, where by the organism to be tested is suspended in a normal saline and ensuring a turbidity is equivalent to that of 0.5 MacFarland.

Inoculate on Muller Hinton Agar plate with the bacterial suspension by using a sterile cotton swab ensuring that the inoculum is covering the whole plate.

Place a disc of Ceftazidime 30µg.

Then place a disc of Ceftazidime + clavulanic acid 30µg/10µg at a distance of 25mm, center to center.

Incubate at 35°C for 16-18 hours.

### Results interpretation and reporting

An increase in the inhibition zone diameter of  $\geq 5$ mm for combination disc (Ceftazidime + clavulanic acid) versus Ceftazidime disc alone confirms ESBL production.

When ESBL confirmation tests using Ceftazidime and Ceftazidime-clavulanate is NEGATIVE use Cefepime 30µg /Cefepime-clavulanate 30/10µg to confirm for ESBL production.

**Note: When reporting ESBL producing bacteria, an accompanying phrase/sentence should be added stating that “This isolate is resistance to all penicillin, monobactams, first, second and third generation cephalosporin”.**



## 7.32.12.2 Detection of Methicillin Resistance Staphylococcus aureus (MRSA)

### Introduction

MRSA is a *Staphylococcus aureus* strain resistant to all  $\beta$ -lactam antibiotics including penicillin, cephalosporin, monobactams and carbapenems, because of the presence

of *mecA*, a gene that produces altered penicillin binding protein (PBP2a) with low affinity for  $\beta$ -lactam antibiotics. Mechanism of oxacillin resistance other than *mecA* are rare. Infections caused by MRSA strain are difficult to treat and associated with increased hospital stay, mortality and morbidity.

### Procedure notes

Prepare a bacterial suspension by using a wire loop, where by the organism to be tested is suspended in a normal saline and ensuring a turbidity is equivalent to that of 0.5 MacFarland.

Inoculate on Muller Hinton Agar plate with the bacterial suspension by using a sterile cotton swab ensuring that the inoculum is covering the whole plate.

Apply Cefoxitin 30 $\mu$ g disks to agar surface using sterile forceps or dispenser or multiple inoculator. Apply gentle pressure to ensure complete contact of disk with agar.

Invert plate and incubate within 15 minutes of disk application. Incubate for 16 – 18 hours or 24 hours at 33 to 35°C in an ambient air incubator (Testing at temperatures above 35°C may not detect MRSA)

### Results interpretation and reporting

< 21 mm = *mecA* positive: Report as Oxacillin Resistant (do not report Cefoxitin)

> 22 mm = *mecA* negative: Report as Oxacillin Sensitive (do not report Cefoxitin)

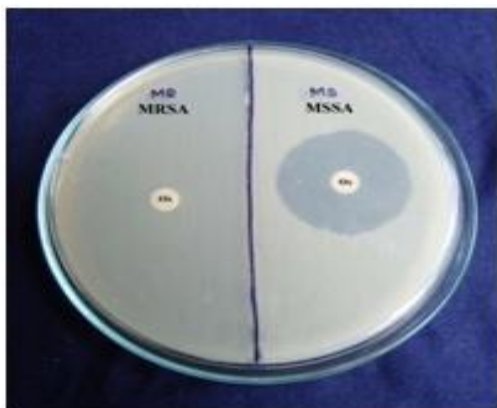

**Note:** When reporting MRSA strains, an accompanying phrase/sentence should be added stating that “This isolate is resistance to all beta lactam antibiotics such as penicillin, monobactams, cephalosporin and carbapenems”.

### 7.32.12.3 Detection of Vancomycin Resistance *Enterococcus faecalis*

#### Introduction



Clinically relevant resistance is most often mediated by plasmid-encoded VanA and VanB ligases that replace the terminal D-Ala(nine) in the peptidoglycan with D-Lac(tate). This substitution reduces the binding of glycopeptides to the target. VanA-producing strains exhibit resistance to both vancomycin and teicoplanin, whereas VanB-producing strains usually remain susceptible to teicoplanin due to lack of induction of the resistance operon.

### **Procedure notes**

Prepare a bacterial suspension by using a wire loop, where by the organism to be tested is suspended in a normal saline and ensuring a turbidity is equivalent to that of 0.5 MacFarland.

Inoculate on sheep Blood Agar plate with the bacterial suspension by using a sterile cotton swab ensuring that the inoculum is covering the whole plate.

Apply vancomycin 5 $\mu$ g disks to agar surface using sterile forceps or dispenser or multiple inoculator. Apply gentle pressure to ensure complete contact of disk with agar.

Invert plate and incubate within 15 minutes of disk application. Incubate for 16 – 18 hours or 24 hours at 33 to 35°C in an ambient air incubator

### **Results interpretation and reporting**

Sharp zone edges indicate that the isolate is susceptible and isolates with zone diameters above the breakpoint can be reported as vancomycin susceptible. Isolates with fuzzy zone edges or colonies within the zone may be resistant regardless of zone size and should not be reported as susceptible.

Vancomycin susceptibility is done using an MIC method (with either E-test or Broth macrodilution test): strains with MIC's:  $\leq 2\mu\text{g/ml}$  = Sensitive, 4-8 $\mu\text{g/ml}$  = Intermediate, and  $\geq 16\mu\text{g/ml}$  = Resistant

#### ***7.32.12.4 Detection of Inducible clindamycin resistance (D-test)***

##### **Introduction**

Clindamycin is an attractive agent for empirical therapy for suspected *S. aureus* infections because of its excellent pharmacokinetic and pharmacodynamic properties. Clinical failures of clindamycin therapy for treatment of MRSA infections have been documented for strains that were clindamycin sensitive but erythromycin resistant. The failures were due to inducible resistance to clindamycin.

In such cases, In vivo, therapy with Clindamycin may select for constitutive erm mutants, which may lead to clinical failure. Clindamycin resistance may be constitutive or inducible. Routine antibiotic susceptibility tests cannot identify these strains. The D (inducible clindamycin resistance) test is employed to detect inducible clindamycin resistance.

The test is done when routine testing of *S. aureus* shows sensitive to clindamycin and resistant to erythromycin, in this case clindamycin may not be considered for treatment hence a confirmatory must be done.

### Procedure notes

Prepare a bacterial suspension by using a wire loop, where by the organism to be tested is suspended in a normal saline and ensuring a turbidity is equivalent to that of 0.5 MacFarland.

Inoculate on Muller Hinton Agar plate with the bacterial suspension by using a sterile cotton swab ensuring that the inoculum is covering the whole plate.

Put Clindamycin (2- $\mu\text{g}$ ) and Erythromycin (15- $\mu\text{g}$ ) disks approximately 15 mm apart (measured edge to edge).

Incubate the plate for 16 to 18 hours at 35 to 37°C

### Results interpretation and reporting

A clear, D-shaped zone of inhibition around the Clindamycin disk is designated as the D phenotype which is labeled as D or D+. Four other non-induction phenotypes (designated as negative [Neg], hazy D zone [HD], resistant [R], and susceptible [S]) are also observed in disk diffusion results

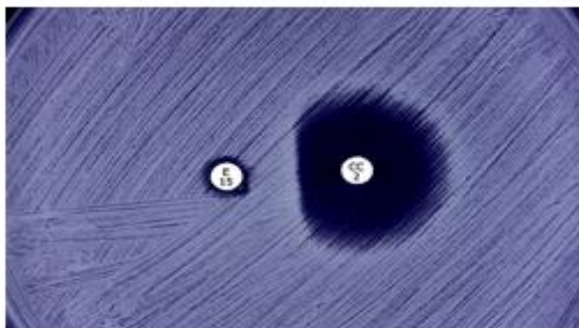

A positive D-test for inducible clindamycin resistance (Lewis and Jorgensen, *Clin Infect Dis.* 2005;40:280-285.)

**Note:** When reporting *S. aureus* strains with D-test positive, an accompanying phrase/sentence should be added stating that “This isolate is resistance both erythromycin and clindamycin”.

### 7.32.12.5 Detection of Carbapenems resistant Enterobacteriaceae

#### Introduction

Carbapenemases are enzymes capable of hydrolysing beta lactam antibiotics called carbapenems (e.g. ertapenem, Meropenem and Imipenem). Most often these enzymes are also capable of hydrolysing the first, second, third and fourth generation cephalosporin; and penicillin), but they do not hydrolyse monobactams (e.g. aztreonam).

**These enzymes include:**

*Klebsiella pneumoniae* Carbapenemases (*bla*KPC): plasmid mediated genes.

New Delhi Metallo-beta lactamases (*bla*NDM).

Imipenemases (*bla*IMP)

Veron Integron beta lactamases (VIM)

They occur in Enterobacteriaceae (e.g. *Escherichia coli*, *Klebsiella* species and *Enterobacter* species), and in *Pseudomonas aeruginosa* and *Acinetobacter* species. Therefore, when these isolates test non susceptible to one of the following carbapenems: Meropenem, or Imipenem a confirmatory test must be done

**Procedure Steps: Confirmatory test: Modified Carbapenems Inactivation Methods (mCIM) for suspected Carbapenemases production in Enterobacteriaceae and *Pseudomonas aeruginosa***

- i. Emulsify loopful of bacteria (from Blood-agar) in normal saline test tube
- ii. Vortex for 10-15 seconds
- iii. Add 10µg meropenem disk to test tube immersing the entire disk
- iv. Incubate at 35°C for 4 hours
- v. Prepare 0.5 McFarland suspension of *E. coli* ATCC 25922 in normal saline
- vi. Inoculate *E. coli* inoculum suspension on MHA for normal disk diffusion
- vii. Remove imipenem disk using 10µL loop and placing it on inoculated MHA plate {Disk capacity 4 disks on a 100mm MHA plate}
- viii. Add fresh imipenem for control
- ix. Incubate MHA at 35 to 37°C for 18-24 hours in aerobic atmosphere

**7.32.13 Biological References interval**

Not applicable

**7.32.14 Results interpretation and reporting**

**Positive results:**

Pinpoint colonies of *E. coli* (indicator organism) observed within the zone of inhibition

If colonies are present within a 6mm – 18mm zone of inhibition

**Indeterminate results:**

If colonies are present within a >19mm zone – test should be considered indeterminate

**Negative results:**

No colonies present within the zone of inhibition.



### **7.32.15      *Limitation of the Procedure and Sources of Error***

Heavy or light inoculum

Disc potency

### **7.32.16      *Performance characteristics***

Refer to the method verification report of this procedure

### **7.32.17      *Supporting Document***

Sample collection manual, safety manual and method verification report

### **7.32.18      *References***

1. Cesur, S. and Demiröz, A.P., 2013. Antibiotics and the mechanisms of resistance to antibiotics. *Medical Journal of Islamic World Academy of Sciences*, 109(1007), pp.1-5.
2. EUCAST guideline for the detection of resistance mechanisms and specific resistances of clinical and/or epidemiological importance ,revised version 2017
3. <https://microbeonline.com/inducible-clindamycin-resistance-d-test-principle-procedure-and-interpretation/>

# CHAPTER 8: MOLECULAR BIOLOGY

---

## 8.1 DIAGNOSIS OF MTB/RIF TESTING USING A TRUENAT MACHINE

### 8.1.1 Purpose

The purpose of SOP is to describe the stepwise procedure for the rapid detection of Mycobacteria tuberculosis (MTB) and detection of rifampicin resistance using Truenat MTB/RIF test for use with the Truenat Dx system is a semi-quantitative real-time PCR *in-vitro* diagnostic test for: The detection of MTB DNA in sputum samples, detection of rifampicin resistance-associated mutations of the *rpoB* gene. The purpose of SOP is to describe the stepwise procedure for the rapid detection of Mycobacteria tuberculosis (MTB) and detection of rifampicin resistance using Truenat. MTB/RIF test for use with the TrueNat Dx system is a semi-quantitative real-time PCR *in-vitro* diagnostic test for; detection of MTB DNA in sputum samples and detection of rifampicin resistance-associated mutations of the *rpoB* gene.

### 8.1.2 Scope

This SOP describes the use of the Truenat™ MTB Plus assay, a chip-based Real-Time Polymerase Chain Reaction (PCR) test, for the semi-quantitative, detection and diagnosis of Mycobacterium tuberculosis complex bacteria (MTBC) in human sputum samples

### 8.1.3 Responsibility

Qualified and competent health laboratory practitioners are responsible for implementing this test procedure.

The section head is responsible for ensuring the effective implementation and maintenance of this procedure.

### 8.1.4 Principle

The TrueNat assays utilize chip-based real-time micro-polymerase chain reaction (PCR) for detection of TB and RIF-resistance from Deoxyribonucleic Acid (DNA) that is extracted from sputum sample within an hour.

Truenat™ MTB Plus works on the principle of Real-Time Polymerase Chain Reaction where the sputum sample is first liquefied and lysed thereafter the extracted DNA from the sample is then amplified by the Truelab Real-Time micro-PCR analyser. The purified DNA is then dispensed into the reaction well of the Truenat™ MTB Plus chip and the test is started.

- **Description of the apparatus**



**Figure 7: Truenat DX System Components**

Trueprep AUTO Sample Prep device Truelab™ Real Time micro PCR Analyser

### 8.1.5 Sample Requirements

Sputum sample type, collected as either Spot or morning sputum sample

### 8.1.6 Equipment

True prep AUTO Sample Prep device, Truelab Real Time micro PCR Analyser and Refrigerator

### 8.1.7 Materials

Extraction of DNA	Amplification of purified DNA	Materials required but not provided	Reagents and Solutions
<ul style="list-style-type: none"> <li>• Trueprep AUTO v2 Universal Cartridge Based Sample Prep Device</li> <li>• Trueprep AUTO MTB Sample Pre-treatment Pack</li> <li>• Trueprep AUTO v2 Universal Cartridge Based Sample Prep Kit</li> </ul>	<ul style="list-style-type: none"> <li>• Truelab Duo Real Time Quantitative micro PCR Analyzer</li> <li>• Truenat™ MTB Plus micro PCR chip</li> <li>• Truelab™ micro PCR printer</li> <li>• Truepet SPA fixed volume (6 µl) Precision micropipette</li> <li>• DNase and RNase-free pipette tips with filter barrier</li> </ul>	<ul style="list-style-type: none"> <li>• Truenat™ Positive Control Kit - Panel I</li> <li>• Powder free disposable gloves</li> <li>• Two waste disposal containers, with lids, containing bleach solutions</li> <li>• Timer</li> <li>• Two waste bags</li> <li>• Micro tube Stand</li> <li>• Cartridge Holder</li> <li>• Two cryovials racks</li> </ul>	<ul style="list-style-type: none"> <li>• Liquefaction buffer</li> <li>• Lysis buffer</li> <li>• Conc. bleach and 70% alcohol</li> </ul>

**Note:** Connect a new reagent pack to the Trueprep Auto v2 device by inserting the Plug-in Connector into the slot provided.

### 8.1.8 Storage and Stability

store at room temperature for 3 days

Store at 2°C -8°C

### **8.1.9 Safety**

- Treat all biological samples, including used cartridges, as if capable of transmitting infectious agents. Because it is often impossible to know which might be infectious, all biological samples should be treated with universal precautions.
- Wear protective disposable gloves, laboratory coats and eye protection when handling samples and reagents.
- Wash hands thoroughly after handling samples and test reagents. Follow safety procedures for working with chemicals and handling biological samples, (See safety manual)
- Dispose used cartridges according to infectious waste material disposal guidelines.

### **8.1.10 Calibration**

Calibration is performed as per schedule

### **8.1.11 Quality Control**

- Use Truenat Positive Control Kit- Panel containing Positive Control and Negative Control or use PBS as a negative control and a known positive culture sample.
- Run positive and negative controls at least one time per month or
  - When opening a new o test kit lot.
  - If the temperature of the storage area falls outside of 2-30°C.
  - New user prior to performing testing on the clinical sample.
  - Accept patient results if the positive controls give positive results while negative controls give negative results. Corrective action should be taken in case of QC failure either by repeating the control and/or informing the supervisor.
  - Whenever a new shipment of test kits is received.
- Records QC results in the TB register.

### **8.1.12 Procedural Steps**

#### **A. Equipment start-up procedure**

- Press the “Power” button to switch on the Truenat device.
- Press ‘start’ and ‘eject’ simultaneously to reset when prompted to change the Reagent Pack and reset

#### **B. Sample Processing procedure**

#### **Prepare Sample and Extract DNA**

- i. Wear gloves for sample handling.
- ii. Label Sputum sample with patient details or laboratory ID
- iii. Add 2 drops of liquefaction buffer to the sputum sample
- iv. Close the cap and swirl gently to mix

- v. Incubate for 10 minutes at room temperature. If sample is not pipetteable after 10 minutes, incubate for another 5 minutes with swirling at 2-minute intervals
- vi. Transfer 0.5 ml of liquefied sputum sample into the lysis buffer bottle using a 1 ml transfer pipette
- vii. Add 2 drops of liquefaction buffer into the lysis buffer bottle, swirl gently to mix and incubate for 3-5 minutes
- viii. Remove the cartridge from the pouch, label it and place it on the cartridge stand. Take out the elute collection tube (ECT) and label it appropriately. Keep it aside for later use. Keep the elute transfer pipette in the pouch for later use.
- ix. Transfer the entire contents of the lysis buffer tube to the sample chamber (black cap) of the cartridge using 3 ml transfer pipette
- x. Switch “on” the Trueprep® AUTO v2 device. Press “eject” button to open and gently pull out the cartridge holder
- xi. Place the cartridge in the tray, and gently push to close the cartridge holder. Press “start.”
- xii. The device will beep at the end of the DNA extraction process (20 minutes), and the cartridge holder will eject automatically.
- xiii. Gently pull out the cartridge holder, remove the cartridge, and place it on the cartridge stand.
- xiv. Carefully pierce the elute chamber with the provided elute transfer pipette, and transfer the entire elute into the ECT. Discard the transfer pipette and cartridge

### **C. Running a PCR TB Test**

- i. Switch “on” the Truelab microPCR analyser by pressing the red button in the back right corner for 2 seconds. LED will glow in Green. Wait for 30-50 seconds for “boot-up screen” to appear followed by “home screen.”
- ii. Select USER ID, enter password. Press “Sign in” to Log in
- iii. Select test profile “MTB” or “MTB Plus”. To confirm selection tap “PROCEED” and enter patient details (referred by, patient ID, gender, patient name & age)
- iv. Select sample type (sputum).
- v. Open a TRUENAT™ MTB Plus chip pouch \*Pull out the orange desiccant pouch and confirm that it is orange in colour.
- vi. Gently take out the chip without touching white well portion and place it on the chip tray by aligning it in the slot provided
- vii. Press “START TEST” on the screen. Chip tray opens. “Please Load Sample” will appear. (Don’t press “YES” until chip loading is complete.
- viii. Open the master mix tube, discard the stopper and place the tube in the micro tube stand. \*Check for white cake at the bottom of the micro tube.
- ix. Attach the 6ul micro tip provided in the pouch to the single push pipette.
- x. Transfer 6ul of the elute from ECT into the master mix tube
- xi. Allow the master mix to stand for 30 SECONDS to get a clear solution. \*Do not mix by tapping, shaking or reverse pipette. \*Do not discard the pipette tip.



- xii. Transfer the elute from the master mix tube to the white reaction well of the chip (Figure 16). \*Avoid spillage of the clear solution outside the white reaction well.  
\*Discard the pipette tip and master mix tube.
- xiii. Click “YES” on the device screen to start the test. The PCR will be completed in 35 minutes.
- xiv. Tap the “Open/Close Tray” button to eject the chip tray and discard the used chip immediately after the reaction.
- xv. If MTB is detected test the same elute for RIF resistance using the Truenat MTB RIF Dx chip as a follow-on test. The test takes about 55 minutes.

#### **D. Running a RIF-Resistance Test**

- i. If MTB is detected in a sample, Run a RIF resistance test.
- ii. Use a portion of the same DNA eluate to test for RIF resistance using a Truenat MTB-RIF Dx chip.
- iii. Start by returning to Step 3 in the PCR TB test process and repeat for RIF-resistance by Selecting “MTB RIF” as the test type in the Truelab micro-PCR Analyser.
- iv. RIF-resistance testing takes an additional 60 minute.

#### **8.1.13 Biological Reference Interval**

Not applicable

#### **8.1.14 Interpretation and Reporting of Results**

##### **Interpretation** of results

At the end of the test run, the result screen will display;

- i. “DETECTED” for Positive result.
- ii. “NOT DETECTED” for Negative results.
- iii. MTB load as “HIGH”, “MEDIUM”, “LOW” or “VERY LOW” for positive.
- iv. The result screen also displays the validity of the test run as “VALID” or “INVALID”.

NOTE: Invalid samples have to be repeated with fresh samples from the sample preparation stage.

IPC will co-amplify in most positive cases also, in some samples having a high target load, the IPC may not amplify, however, the test run is still considered valid

Sample with MTB DETECTED should be tested for MTB RIF

##### **Reporting of results**

Click “VIEW RESULTS” on the menu bar. The View Results window appears.

Optional: Press “Print” to print the result page using Truelab® microPCR printer.

## **Critical value**

MTB Detected RIF Resistance Detected

### **8.1.15 Limitation of the Procedure and Sources of Error**

- i. Optimal performance of this test requires appropriate sample collection, handling, storage and transport to the test site.
- ii. Though very rare, mutations within the highly conserved regions of the target genome where the Truenat™ assay primers and/or probe bind may result in the under-quantitation of or a failure to detect the presence of the concerned pathogen.
- iii. The instruments and assay procedures are designed to minimize the risk of contamination by PCR amplification products. However, it is essential to follow good laboratory practices and ensure careful adherence to the procedures specified in this package insert for avoiding nucleic acid contamination from previous amplifications, positive controls or samples.
- iv. A sample for which the Truenat™ assay reports “Not Detected” cannot be concluded to be negative for the concerned pathogen. As with any diagnostic test, results from the Truenat™ assay should be interpreted in the context of other clinical and laboratory findings.
- v. The performance of the test has not been evaluated with samples processed by methods other than those described in the package insert.
- vi. Do not open the cartridge lid except when adding sample.
- vii. Do not use a cartridge if it appears wet or if the lid seal appears to have been broken.
- viii. Do not use a cartridge that has a damaged reaction tube.
- ix. Each single-use cartridge is used to process one test. Do not reuse spent cartridges.

### **8.1.16 Performance Characteristics**

Refer to the method verification report of this procedure.

### **8.1.17 Supporting Document**

Sample collection manual

### **8.1.18 References**

- Truenat MTB Plus package insert version 5.
- The Trueprep™ AUTO v2 Universal Cartridge Based Sample Prep Device user manual.
- TBRL Bamenda Biosafety manual, Version 4.0, section 10.
- Truenat™-A Point-of-care Real Time PCR Test for Tuberculosis, video by Molbio available at <https://youtu.be/ydR2I5S2v3>

## **8.2 DIAGNOSIS OF MTB/RIF BY USING GENE XPERT SYSTEM**

### **8.2.1 Purpose**

This procedure provides instructions for performing sample which is suspect with MTB/Rif

### **8.2.2 Scope**

This procedure is used for detection of the *Mycobacterium tuberculosis* complex bacteria and their rifampicin susceptibility using the GeneXpert MTB/Rif system in microbiology section in the Laboratory.

### **8.2.3 Responsibility**

Qualified, trained, Competent and Registered health laboratory personnel is responsible for ensuring the effective implementation for this procedure.

### **8.2.4 Principle**

The GeneXpert MTB/RIF system is a fully automated nested real-time PCR system, which detects MTB complex DNA in smear positive and negative sputum samples and other body fluid i.e. pleural fluid, ascetic fluid CSF and Pus. It simultaneously identifies mutations in the rpoB gene, which are associated with rifampicin resistance.

### **8.2.5 Sample Requirements**

- Collect minimum 1ml and maximum 4ml of sputum or other body fluid
- Do not accept samples with obvious food particles or other solid particulates or blood stained (for this do Auramine O or ZN Stain)

### **8.2.6 6.0 Materials**

- MTB/RIF cartridges, Sample Reagent, Disinfectant solution (0.5% Jik and 70% alcohol), Sterile disposable transfer pipettes, Sterile screw-capped sample collection containers, Disposable gloves, Plastic bag for waste disposal, Labels and/or indelible labeling marker, Sterile pipettes for sample processing.

### **8.2.7 Equipment**

- GeneXpert machine, Microscope, Personal Protective Equipment such as N95 respirator and Timer

### **8.2.8 Storage and stability**

- Sputum sample may be stored at 2-8 °C before examinations.
- Protect the Sputum samples from direct sunlight.
- Store the Gene xpert cartridges at 2-8°C

### **8.2.9 Safety**

- i. Decontaminate working surfaces twice daily, in the morning and afternoon
- ii. Adhere to safety precautions as stated in the Safety manual
- iii. All personal protective equipment (PPE) must be worn when performing this procedure.
- iv. All samples must be regarded as potentially infectious.
- v. Avoid any contact between hands and eyes and nose during sample collection and testing.
- vi. Do not use kit beyond the expiration date which appears on the package label or device in a damaged pouch.
- vii. All spills should be wiped thoroughly using 1% sodium hypochlorite solution.

### **8.2.10 Calibration**

Calibrate auxiliary equipment used in this operating this procedure once a year and keep record available is performed once per year.

### **8.2.11 Quality Control**

- The quality control will be performed on weekly bases (every week).
- Positive and negative known sample will be used.
- Ensure that all MTB/RIF cartridges and sample reagents used have passed the required are used within their expiry date

### **8.2.12 Procedure Steps**

#### ***Start-up the GeneXpert instrument and Preparation of sample***

- i. Disinfect the working area by 0.5% jik.
- ii. Label each Xpert MTB/RIF cartridge with the sample ID (e.g. NEW X\_2016, HIV X\_2016 or KID X\_2016). Do not put the label on the lid of the cartridge or obstruct the existing 2D barcode on the cartridge. Write on the sides of the cartridge or affix ID label.
- iii. Leave sample in leak-proof sputum collection container.
- iv. Unscrew lid of sputum collection container, add Sample Reagent 2:1 (v/v) to sample and close the lid again.
- v. Shake vigorously 10 - 20 times.
- vi. Incubate for 5 minutes at room temperature.
- vii. Shake the sample again vigorously 10 – 20 times.
- viii. Continue incubation for another 10 minutes.

**Note:** *Samples should be liquefied with no visible clumps of sputum. If there are still clumps of sputum, shake again vigorously and incubate for another 3-5 min.*

### **8.2.13 Preparing the Cartridge**

- Start the test within 30 minutes of adding the sample to the cartridge
- Using the sterile transfer pipette provided, aspirate the liquefied sample into the transfer pipette until the meniscus is above the minimum mark (= 2ml). Open the cartridge lid. Transfer sample into the open port of the Xpert MTB/RIF cartridge

- NOTE: It is crucial that no bubbles are created when transferring the sample into the cartridge as this can lead to an error (no result).
  - ✓ Dispense slowly to minimize the risk of aerosol formation.
  - ✓ Close the cartridge lid. Make sure the lid snaps firmly into place.
- Note: Remaining liquefied sample may be kept for up to 12 hrs at 2-8°C should repeat testing be required.

#### **8.2.14 Start the test on the GeneXpert instrument**

**Note: Before start processing the sample, check that the GeneXpert instrument is functioning and the modules are available.**

- I. Turn on the computer, and then turn on the GeneXpert instrument.
- II. On the Windows desktop, double-click the GeneXpert shortcut icon.
- III. Log on to the GeneXpert System software using your user name and password.
- IV. Click on “CHECK STATUS” and check if modules are available. If not proceed to “Troubleshooting” in User’s manual.
- V. In the GeneXpertDx System window, click “CREATE TEST”. The Scan Cartridge Barcode dialog box appears.
- VI. Scan the barcode on the Xpert MTB/RIF cartridge.
- VII. The Create Test window appears.
- VIII. Using the barcode information, the software automatically fills the boxes for the following fields: Select Assay, Reagent Lot ID, Cartridge SN, and Expiration Date.
- IX. In the Sample ID box (ID=Patient names), scan or type the sample ID (e.g. NEW X\_2016, HIV X\_2016 or KID X\_2016). Make sure you type the correct sample ID. The sample ID is associated with the test results and is shown in the “View Results” window and all the reports
- X. Choose module.
- XI. Click “Start Test”.
- XII. In the dialog box that appears, type your password.
- XIII. Open the instrument module door with the blinking green light and load the cartridge.
- XIV. Close the door.
- XV. The test starts and the green light stops blinking.
- XVI. Wait until the system releases the door lock at the end of the run, then open the module door and remove the cartridge.
- XVII. Dispose of used cartridges in the appropriate sample waste containers according to your institution’s standard practices

#### **8.2.15 Biological Reference interval**

- Not Applicable

#### **Interpretation and Reporting of Results**

- MTB DETECTED, Rif Resistance DETECTED –RR
- MTB DETECTED, Rif Resistnce INDETERMINATE –TI

- MTB DETECTED Rif Not DETECTED – T
- MTB NOT DETECTED – N
- This is DNA based test, meant for **New TB suspect**, ensure don't enrol 'follow-up' patient.
  - ✓ The results are interpreted by the GeneXpert Dx system from measured fluorescent signals and embedded calculation algorithms and will be displayed in the “**View Results**” window. Lower Ct values represent a higher starting concentration of DNA template; higher Ct values represent a lower concentration of DNA template.
  - ✓ **Critical values** MTB DETECTED, Rif Resistance DETECTED –RR

### **8.2.16 Limitation of the Procedure and Sources of Error**

- Perform the test and validate results as per this SOP and details of test package insert. Reliable results depend on proper sample collection, handling, and storage. A positive test result does not necessarily indicate the presence of viable organisms. It is however, presumptive for the presence of MTB and rifampicin resistance. The results might be affected by antecedent or concurrent anti-TB drug therapy.

### **8.2.17 Performance Characteristics**

Refer to the verification report of GeneXpert.

### **8.2.18 Supporting Document**

Sample collection manual and safety manual

### **8.2.19 References**

1. Clinical Microbiology Procedures Handbook. American Society for Microbiology. Washington D.C., USA, 2<sup>nd</sup> edition, 2007.
2. Monica cheesbrough (2005). District Laboratory Practice in Tropical countries. Cambridge University Press, New York, USA, 2<sup>nd</sup> edition, 2005.
3. WHO, (2003). Manual of basic techniques for a health laboratory. Geneva. 2<sup>nd</sup> edition, 2003.
4. Manual of Clinical Microbiology. American Society for Microbiology (ASM), Washington D.C., USA. 9<sup>th</sup> edition, 2007.
5. Manual for the Laboratory Identification and Antimicrobial Susceptibility Testing of Bacterial Pathogens of Public Health Importance in the Developing World. U.S. Centers for Disease Control and Prevention (CDC), Atlanta, Georgia, U.S.A, and World Health Organization (WHO) Geneva Switzerland. 2003.
6. International Union against Tuberculosis and Lung Disease. The Public Health Service National Tuberculosis Reference Laboratory and the National Laboratory Network. Paris; 1998.

## **8.3 DETERMINATION OF HIV -1 VIRAL LOAD BY USING GENE EXPERT SYSTEM**

### **8.3.1 Purpose**

This SOP outlines the steps for qualitative *in vitro* diagnostic HVL test by using automated GeneXpert system.

### **8.3.2 Scope**

The Xpert HIV-1 VL assay is an *in vitro* reverse transcriptase polymerase chain reaction (RT-PCR) assay for the detection and quantification of Human Immunodeficiency Virus type 1 (HIV-1) RNA in human plasma from HIV-1 infected individuals, using the automated GeneXpert Instrument Systems. The assay can quantify HIV-1 RNA over the range of 40 to 10,000,000copies/mL. The Xpert HIV-1 VL assay is validated for quantification of RNA from HIV-1 Group M (subtypes A, B, C, D, F, G, H, J, K, CRF01\_AE, CRF02\_AG, and CRF03\_AB), Group N, and Group O.

The Xpert HIV-1 VL assay is intended for use in conjunction with clinical presentation and other laboratory markers for disease prognosis and for use as an aid in assessing viral response to antiretroviral treatment as measured by changes in plasma HIV-1 RNA levels.

The Xpert HIV-1 VL assay is not intended to be used as a donor screening test for HIV-1 or as a diagnostic test to confirm the presence of HIV-1 infection

### **8.3.3 Responsibility**

The Qualified, competent and registered health laboratory practitioners are responsible to carry out this procedure.

The head of section is responsible for ensuring the effective implementation and competency assessment for this procedure

### **8.3.4 Principles**

#### ***Principle of the Procedure***

GeneXpert Instrument Systems automate and integrate sample preparation, nucleic acid extraction and amplification, and detection of the target sequence in simple or complex samples using real-time reverse transcriptase PCR (RT-PCR). The systems consist of an instrument, personal computer, and preloaded software for running tests and viewing the results. The systems require single-use disposable GeneXpert cartridges that contain the RT-PCR reagents and carry out the sample extraction and RT-PCR processes. Because the cartridges are self-contained, cross-contamination between samples is minimized. For a full description of the systems, refer to the appropriate *GeneXpert Dx Operator Manual* or *GeneXpert Infinity Operator Manual*.

The HIV-1 VL assay includes reagents for the detection of HIV-1 RNA in samples and two internal controls used for quantitation of HIV-1 RNA. The internal controls are also

used to monitor the presence of inhibitor(s) in the RT and PCR reactions. The Probe Check Control (PCC) verifies reagent rehydration, PCR tube filling in the cartridge, probe integrity, and dye stability

### ***Principle of operation***

Each GeneXpert Dx module processes one sample. You insert the sample and applicable reagents into a GeneXpert cartridge, create a test, load the cartridge into an available instrument module, and then start the test. During the test, the system performs the following steps:

- i. Moves the sample and reagents into different chambers in the cartridge for sample preparation.
- ii. Hydrates the reagent beads.
- iii. Performs probe checks to ensure that the sample preparation is successful (only if the assay definition requires this step).
- iv. Moves the sample and reagent mixture into the reaction tube.
- v. Starts the PCR cycles and real-time detection.

### **8.3.5 Sample Requirement.**

- DBS collected as per SOP for collection of DBS.
- Anticoagulated whole blood(WB) B in sterile tubes using EDTA (lavender top) as the anticoagulant as per the manufacturer’s instructions for use.
- A minimum of 100 µL of WB is required for the HIV-1 Qualitative assay.

### **8.3.6 Equipment**

Perform equipment Start up, Maintenance, trouble shoot and shut down refer manufacturer instructions.

Biosafety cabinet, Data computer connected to LIS (Optional), Printer (optional), GeneXpert instrument and GeneXpert Software should be available.

### **8.3.7 Materials**

Reagent kit content	Extra supplies
<p>The HIV-1 Qual assay kit contains sufficient reagents to process 10 samples or quality control samples. The kit contains the following:</p> <ul style="list-style-type: none"> <li>• HIV-1 Qual assay Cartridges with Integrated Reaction Tubes 10</li> <li>• Bead 1, Bead 2, and Bead 3 (freeze-dried) 1 of each per cartridge</li> <li>• Lysis Reagent (Guanidinium Thiocyanate) 1.4 mL per cartridge</li> <li>• Rinse Reagent 0.5 mL per cartridge</li> </ul>	<ul style="list-style-type: none"> <li>• Serviette/Wipe</li> <li>• Bleach</li> <li>• 70 % alcohol or methylated spirit</li> <li>• Labelling marker</li> <li>• Optional: sterile pipettes for sample processing</li> <li>• Laboratory coat,</li> <li>• Non - powdered gloves</li> </ul>



<ul style="list-style-type: none"> <li>• Elution Reagent 2.5 mL per cartridge</li> <li>• Binding Reagent 2.4 mL per cartridge</li> <li>• Proteinase K Reagent 0.48 mL per cartridge</li> <li>• HIV-1 Qual assay Sample Reagent Set (Sample Reagent) 10</li> <li>• Lysis Reagent (Guanidinium Thiocyanate) 1.0 mL per vial</li> </ul> <p>Disposable 1 mL Transfer Pipettes 1 bag of 10 per kit          Disposable 100 µL Transfer Micropipettes 1 bag of 10 per kit</p> <p><b>CD 1 per kit</b></p> <ul style="list-style-type: none"> <li>• Assay Definition Files (ADF)</li> <li>• Instructions to import ADF into GeneXpert software</li> <li>• Instructions for Use (Package Insert)</li> </ul>	
--	--

### **8.3.8 Storage and stability**

#### **Reagents**

- Store the HIV-1 Qualitative assay cartridges and reagents at 2–28 °C.
- Do not use any reagents that have become cloudy or discoloured.
- Do not use a cartridge that has leaked.
- Use cartridge within 30 minutes after adding the sample
- Reagents are stable until their expiration dates when stored and handled as per instruction for use.

#### **Samples**

- DBS cards may be stored at 18–30 °C for 30 days or – 15°C - 20 °C or colder for up to 4 months, or -70 °C for longer storage.
- EDTA-anticoagulated WB may be stored at 31–35 °C for up to 8 hours, 15–30 °C for up to 24 hours or at 2–8 °C for up to 72 hours, prior to sample preparing and testing

### **8.3.9 Safety**

- i. Treat all biological samples, including used cartridges, as if capable of transmitting infectious agents.
- ii. Wear protective disposable gloves, laboratory coats, and eye protection when handling samples and reagents. Wash hands thoroughly after handling samples and test reagents.
- iii. Follow safety procedures for working with chemicals and handling biological samples.
- iv. When processing more than one sample at a time, open only one cartridge; add sample and close the cartridge before processing the next sample. Change gloves between samples.
- v. Do not substitute HIV-1 Qual assay reagents with other reagents.

- vi. Do not open the HIV-1 Qual assay cartridge lid except when adding the Sample Reagent and WB or the Sample Reagent treated DBS sample.
- vii. Do not use a cartridge if it appears wet or if the lid seal appears to have been broken.
- viii. Do not shake the cartridge. Shaking or dropping the cartridge after opening the cartridge lid may yield invalid results.
- ix. Do not use a cartridge that has a damaged reaction tube.
- x. Each single-use HIV-1 Qual assay cartridge is used to process one sample. Do not reuse spent cartridges.
- xi. The single-use disposable pipette is used to transfer one sample. Do not reuse spent disposable pipettes.
- xii. In the event of contamination of the work area or equipment with sample or control materials, disinfect the area with a 1:10 bleach solution and then 70% ethanol. Wipe work surfaces dry completely before proceeding.

### **8.3.10 Calibration**

There is no need to calibrate the GeneXpert Dx instrument. Cepheid performs all of the necessary calibrations before you receive the system. However, Cepheid recommends that the instrument be recalibrated after 1 year of use, based on the initial installation date (or based on the previous calibration for subsequent years) or at 2000 tests per instrument module, whichever comes first.

### **8.3.11 Quality control**

The GeneXpert Dx System automatically performs internal quality control for each sample. During each test, the system uses one or more of the following controls:

**Internal control (IC)**—Verifies the performance of the PCR reagents and prevents a false negative result. The internal control PCR assay assesses if there is any inhibition, possibly by components, in the test sample. The internal control is provided in the cartridge and should be positive in a negative sample.

**Endogenous control (EC)**—Normalizes targets and ensures sufficient sample is used in the test. Because of its low variability, the endogenous control can also be used to indicate sample-inhibitor contamination. The endogenous control is taken from the sample sample.

Each test includes a Sample Volume Adequacy (SVA), a Sample Processing Control (SPC) and Probe Check Control (PCC).

**Sample Volume Adequacy (SVA):** Ensures that the sample was correctly added to the cartridge. The SVA verifies that the correct volume of sample has been added in the sample chamber. The SVA passes if it meets the validated acceptance criteria. If the SVA does not pass, an ERROR 2096 will display if there is no sample or an ERROR 2097 if there is not enough sample. The system will prevent the user from resuming the test.

**Sample Processing Control (SPC):** Ensures that the sample was correctly processed. The SPC is an Armoured RNA in the form of a dry bead that is included in

each cartridge to verify adequate processing of the sample virus. The SPC verifies that lysis of HIV-1 has occurred if the organism is present and verifies that the sample processing is adequate. Additionally, this control detects sample-associated inhibition of the RT-PCR reaction. The SPC should be positive in a negative sample and can be negative or positive in a positive sample. The SPC passes if it meets the validated acceptance criteria.

In addition to the controls, the GeneXpert Dx instrument performs a probe check during the first stage of the test.

**Probe Check Control (PCC):** Before the start of the PCR reaction, the GeneXpert Instrument System measures the fluorescence signal from the probes to monitor bead rehydration, reaction tube filling, probe integrity, and dye stability. The PCC passes if it meets the validated acceptance criteria.

**External Controls:** Internal quality controls should be done weekly by using known HIV-1 DETECTED and HIV -1 NOT DETECTED as the same as the routine EID/DBS samples.

### **8.3.12 Procedural steps**

- Follow the actions described step by step to do each specific task

#### ***Start-up the GeneXpert instrument***

- Turn on the GeneXpert Dx instrument, and then turn on the computer.
- On the Windows desktop, double-click the GeneXpert Dx shortcut icon.
- Log on to the GeneXpert Dx System software using your user name and password.
- Click on "CHECK STATUS" and check if modules are available. If not proceed to "Troubleshooting" in User manual.

**! Note:** Before start processing the sample, check that the GeneXpert instrument is functioning and the modules are available.

#### ***Preparing of cartridge(s)***

- ***EDTA anticoagulated Whole Blood***
  - i. Wear protective disposable gloves.
  - ii. Disinfect the work area by 0.5 % bleach solution followed by 70 % alcohol
  - iii. Wear protective disposable powder free gloves.
  - iv. Label the Sample Reagent vial with the sample identification.
  - v. Inspect the test cartridge for damage. If damaged, do not use.
  - vi. Open the cartridge lid.
  - vii. Use the 1 mL transfer pipette provided to transfer 750 µL of the sample reagent into the sample chamber of the cartridge.

- viii. Allow the Sample Reagent to adjust to room temperature and mix the bottle by inverting before transferring to the cartridge. Transfer exactly 750  $\mu\text{L}$  into the sample chamber of the cartridge.
- ix. Mix the Whole Blood sample by inverting the vial (EDTA or lavender-top tube) at least seven times. Immediately transfer 100  $\mu\text{L}$  using the micropipette provided by squeezing the upper bulb and then releasing to aspirate the blood.
- x. Squeeze again to dispense the blood into the sample chamber of the cartridge where it will mix with the Sample Reagent already in the sample chamber. Alternatively, use an automatic pipette to dispense the blood into the sample chamber of the cartridge. Do **NOT** pour the sample into the chamber!

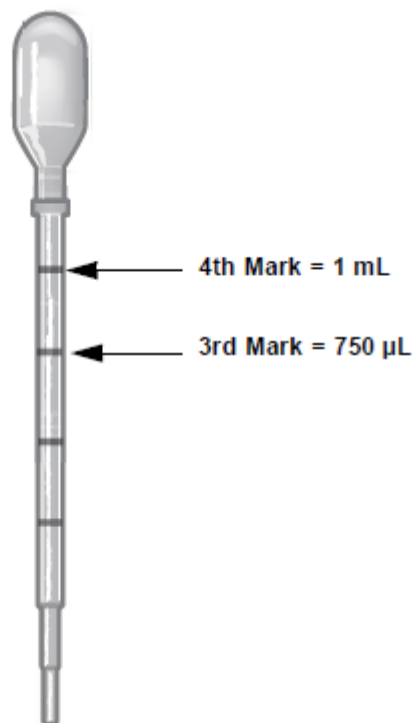

Figure 8: HIV-1 Qual Assay 1 mL Transfer Pipette

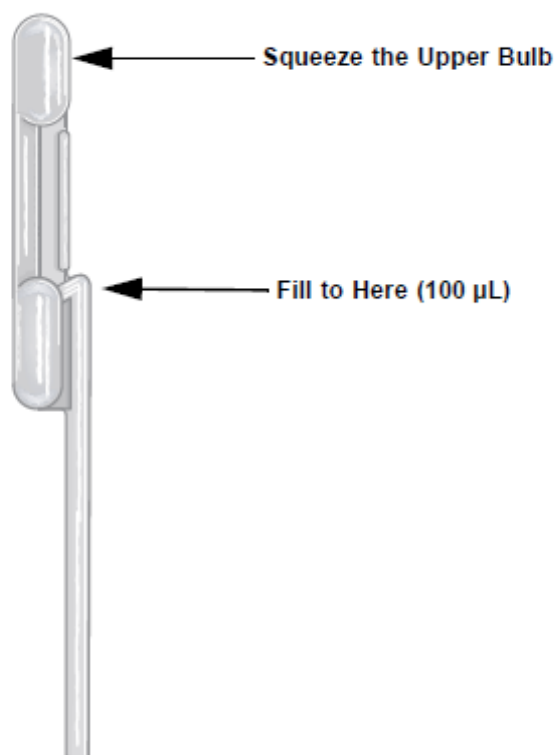

Figure 9: HIV-1 Qual Assay 100 µL Transfer Micropipette



Figure 10: HIV-1 Qual Assay Cartridge (Top View)

❑ **DBS sample**

- i. Wear protective disposable gloves.
- ii. Disinfect the working area.
- iii. Wear protective disposable powder free gloves.
- iv. Before starting, remove the vial containing the Sample Reagent from the kit and, if it was refrigerated, allow to adjust to room temperature. If the vial has not been stored in an upright position, make sure the buffer is settled in the bottom by giving the vial a firm shake.
- v. Turn on Thermo Mixer to heat to 56 °C.
- vi. Label the Sample Reagent vial with the sample identification.
- vii. Using sterilized scissors, excise one entire DBS from the filter paper card for each sample. Follow the delineated lines when excising the

DBS. If perforated circles are used, use clean and sterile pipette tips to detach the DBS.

- viii. Unscrew the lid on the vial containing the Sample Reagent and place one DBS in the vial. Ensure that the DBS is fully submerged in the Sample Reagent buffer.
- ix. Place the vial with the DBS in a Thermo Mixer and incubate for 15 minutes at 56 °C while rotating at 500 rpm.
- x. Inspect the test cartridge for damage. If damaged, do not use.
- xi. Open the cartridge lid
- xii. Use the 1 mL transfer pipette provided to transfer all the liquid from the lysed DBS sample into the sample chamber of the cartridge. Ensure the pipette is filled above the third mark on the transfer pipette. Avoid suction of the DBS with the pipette. Do **NOT** pour the sample into the chamber!
- xiii. Close the cartridge lid, ready to start the test.

**Notes! Change gloves between sample, and each new procedure.**

### ***Starting the Test***

- i. In the GeneXpert System window, click **Create Test**. The scan Cartridge Barcode dialog box appears.
- ii. Scan the barcode on the HIV-1 Qual assay cartridge.
- iii. Using the barcode information, the software automatically fills the boxes for the following fields: Select Assay, Reagent Lot ID, Cartridge SN, and Expiration Date.
- iv. Type the Patient ID, make sure the Patient ID is typed correctly.
- v. Type in the **Sample ID**. Make sure the Sample ID is typed correctly.
- vi. On the **Notes** field, enter the words **KATAVI RRHL** to indicate a testing laboratory name on the patient report.
- vii. Open the instrument module door with the blinking green light and load the cartridge.
- viii. Click **Start Test** (GeneXpert Dx). Enter your user name and password, if requested.
- ix. Close the door.
- x. The test starts and the green light stops blinking. When the test is finished, the light turns off.
- xi. Wait until the system releases the door lock before opening the module door and removing the cartridge.

### ***Result viewing, and printing***

- i. In the GeneXpert Dx System window, Click the **View Results** icon to view results. This view result window appears.
- ii. If the software reports “Error”, Invalid, or No result, repeat the test using new DBS circle.

- iii. Should the test again show Error, Invalid, or No result, proceed to troubleshooting manual to exclude technical problems before requesting a new sample.
- iv. Upon completion of the test, click the **Report** button of the View Results window to view and/or generate a PDF report file.
- v. Report should be done in the Laboratory HEID register and a tick on the respective result blank space on the HEID request form. Report as;  
HIV -1 DETECTED\*.  
HIV -1 NOT DETECTED
- vi. Report “please submit a new sample” if the system repeatedly did not produce a result and you have excluded and/or fixed a technical problem.
- vii. HIV -1 DETECTED is a critical result that needs immediate action including but not limited to; retesting using new DBS circle with a new cartridge, and result notification to the respective referring health facility.

### 8.3.13 Biological Reference Intervals

Not Applicable

### 8.3.14 15. Result interpretation and Reporting of Results.

- The results are interpreted automatically by the GeneXpert Instrument System from measured fluorescent signals and embedded calculation algorithms and are clearly shown in the View Results window. Possible results are shown in Table below:

Result	Interpretation
<b>HIV-1 DETECTED</b> See Figure 1.	The HIV-1 target nucleic acids are detected. <ul style="list-style-type: none"> <li>• The HIV-1 target nucleic acids have a Ct within the valid range.</li> <li>• SPC: NA (not applicable); SPC is ignored because the HIV-1 target amplification occurred.</li> <li>• Probe Check: PASS; all probe check results pass.</li> </ul>
<b>HIV-1 NOT DETECTED</b> See Figure 2.	The HIV-1 target nucleic acids are not detected. SPC meets acceptance criteria. <ul style="list-style-type: none"> <li>• SPC: PASS; SPC has a Ct within the valid range.</li> <li>• Probe Check: PASS; all probe check results pass.</li> </ul>
<b>INVALID</b>	Presence or absence of the HIV-1 target nucleic acids cannot be determined. Repeat test with new sample and cartridge. <ul style="list-style-type: none"> <li>• SPC: FAIL; SPC Ct is not within valid range.</li> <li>• Probe Check: PASS; all probe check results pass</li> </ul>
<b>ERROR</b>	Presence or absence of HIV-1 target nucleic acids cannot be determined. Repeat test with new sample and cartridge. <ul style="list-style-type: none"> <li>• HIV-1: NO RESULT</li> <li>• SPC: NO RESULT</li> <li>• Probe Check: FAIL*; all or one of the probe check results fail.</li> </ul>

	*If the probe check passed, the error is caused by the maximum pressure limit exceeding the acceptable range or by a system component failure.
<b>NO RESULT</b>	<p>Presence or absence of HIV-1 target nucleic acids cannot be determined. Repeat test with new sample and cartridge.</p> <p>A NO RESULT indicates that insufficient data were collected. For example, the operator stopped a test that was in progress.</p> <ul style="list-style-type: none"> <li>• HIV-1: NO RESULT</li> <li>• SPC: NO RESULT</li> <li>• Probe Check: NA (not applicable).</li> </ul>

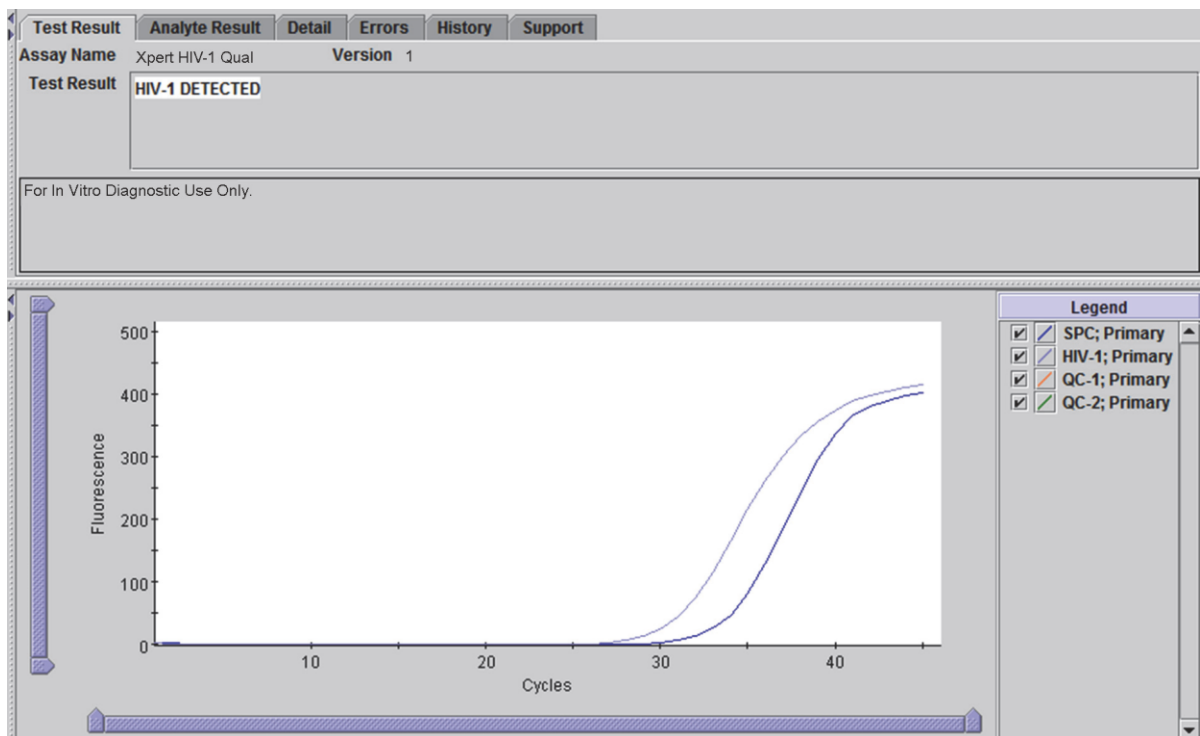

**Figure 11: HIV -1 DETECTED**



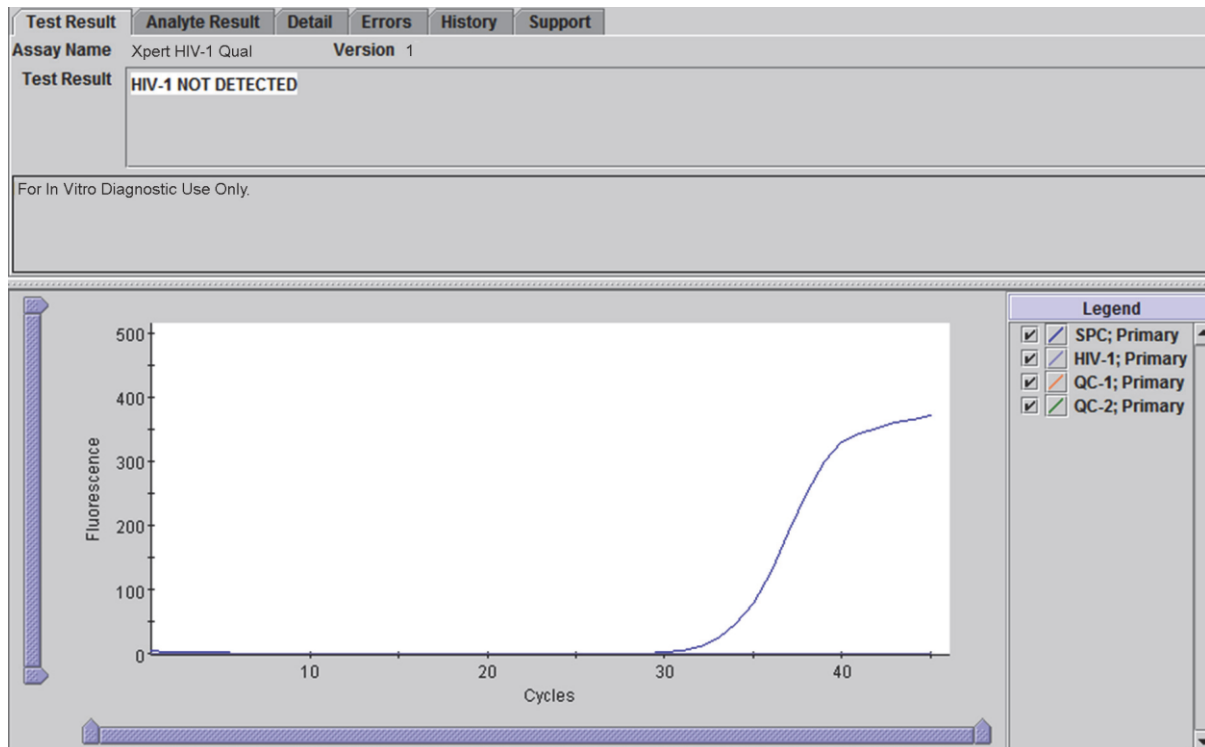

**Figure 12: HIV -1 NOT DETECTED**

### **8.3.15 Limitation of the Procedure and Sources of Error**

Good laboratory practices and changing gloves between handling samples are recommended to avoid contamination of reagents.

Rare mutations within the target region of the HIV-1 Qual assay may affect primer and/or probe binding resulting in failure to detect the virus.

A negative test result does not preclude HIV-1 infection. Results from the HIV-1 Qual assay should be interpreted in conjunction with clinical presentation and other laboratory markers.

### **8.3.16 Performance Characteristics**

Refer to the manufacture package insert and verification report for detailed information on Performance Characteristics of the testing procedure

### **8.3.17 Supporting Documents**

- Sample collection manual and safety manual
- Quality manual

### **8.3.18 References**

- Ministry of Health, Community Development, Gender, Elderly and Children, Standard Operating Procedures for qualitative HIV-1 HEID testing using GeneXpert
- Xpert HIV-1 Qual -1 Assay Package Insert 308-3048 Rev J
- GeneXpert Dx System. Operator Manual

## **8.4 DETERMINATION OF HIV EARLY INFANT DIAGNOSIS BY USING GENEXPERT SYSTEM**

### **8.4.1 Purpose**

This SOP outlines the steps for qualitative *in vitro* diagnostic HIV-1 test by using automated GeneXpert system.

### **8.4.2 Scope**

The HIV-1 Qual assay, is a qualitative *in vitro* diagnostic test designed to detect Human Immunodeficiency Virus Type 1 (HIV-1) total nucleic acids on the automated GeneXpert Systems using human whole blood (WB) and dried blood spot (DBS) samples from individuals suspected of HIV-1 infection. The HIV-1 Qualitative assay is intended to aid in the diagnosis of HIV-1 infection in conjunction with clinical presentation and other laboratory markers. The assay is intended to be used by laboratory professionals or specifically-trained healthcare workers. The assay is not intended to be used as a blood donor screening test for HIV-1.

### **8.4.3 Responsibility**

Section head is responsible effective implementation of this procedure. Only competent laboratory staffs should carry out this procedure. It is the responsibility of each staff to read, understand and implement this procedure.

### **8.4.4 Principle**

#### ***Principle of the Procedure***

The GeneXpert (GX) Instrument Systems automate and integrate sample preparation, nucleic acid extraction and amplification, and detection of the target sequence in simple or complex samples using real time reverse transcription PCR (RT-PCR). The systems consist of an instrument, personal computer, and preloaded software for performing tests and viewing the results. The systems require the use of single-use disposable GeneXpert cartridges that hold the RT-PCR reagents and host the RT-PCR processes. Because the cartridges are self-contained, cross-contamination between samples is minimized. The HIV-1 Qual assay includes reagents for the detection of HIV-1 total nucleic acids in samples as well as an internal control to ensure adequate processing of the target and to monitor the presence of inhibitor(s) in the RT and PCR reactions. The Probe Check Control (PCC) verifies reagent rehydration, PCR tube filling in the cartridge, probe integrity, and dye stability.

### **8.4.5 Principle of operation**

Each GeneXpert Dx module processes one sample. You insert the sample and applicable

reagents into a GeneXpert cartridge, create a test, load the cartridge into an available instrument module, and then start the test. During the test, the system performs the following steps:

- i. Moves the sample and reagents into different chambers in the cartridge for sample preparation.

- ii. Hydrates the reagent beads.
- iii. Performs probe checks to ensure that the sample preparation is successful (only if the assay definition requires this step).
- iv. Moves the sample and reagent mixture into the reaction tube.
- v. Starts the PCR cycles and real-time detection.

#### 8.4.6 Sample requirements

DBS collected as per SOP for collection of DBS.

EDTA Anticoagulated WB in sterile tubes using EDTA (lavender top) as the anticoagulant as per the manufacturer's instructions for use. A minimum of 100 µL of WB is required for the HIV-1 Qualitative assay.

#### 8.4.7 Equipment

Start up, Maintenance, trouble shoot and shut down refer manufacturer instructions  
 Thermo Mixer C for incubation with smart block, Biosafety cabinet, Data computer connected to LIS (Optional) and Printer (optional)

#### 8.4.8 Materials

Materials (Reagents and consumables) used to perform the test.

Reagent kit content	Extra consumables
<p>The HIV-1 Qual assay kit contains sufficient reagents to process 10 samples or quality control samples.</p> <p>The kit contains the following:</p> <p>HIV-1 Qual assay Cartridges with Integrated Reaction Tubes 10</p> <ul style="list-style-type: none"> <li>• Bead 1, Bead 2, and Bead 3 (freeze-dried) 1 of each per cartridge</li> <li>• Lysis Reagent (Guanidinium Thiocyanate) 1.4 mL per cartridge</li> <li>• Rinse Reagent 0.5 mL per cartridge</li> <li>• Elution Reagent 2.5 mL per cartridge</li> <li>• Binding Reagent 2.4 mL per cartridge</li> <li>• Proteinase K Reagent 0.48 mL per cartridge</li> </ul> <p>HIV-1 Qual assay Sample Reagent Set (Sample Reagent) 10</p> <ul style="list-style-type: none"> <li>• Lysis Reagent (Guanidinium Thiocyanate) 1.0 mL per vial</li> </ul> <p>Disposable 1 mL Transfer Pipettes 1 bag of 10 per kit</p> <p>Disposable 100 µL Transfer Micropipettes 1 bag of 10 per kit</p> <p><b>CD 1 per kit</b></p> <ul style="list-style-type: none"> <li>• Assay Definition Files (ADF)</li> </ul>	<ul style="list-style-type: none"> <li>• DBS Collection Kit (Filter paper cards, e.g., Whatman 903, Munktell or equivalent, lancets, desiccants, plastic sealable bags, and swabs)</li> <li>• Scissors, sterile (recommended for excising DBS from filter paper if not using a perforated DBS card)             <ul style="list-style-type: none"> <li>• Sterile pipette tips</li> <li>• Serviette/Wipe</li> <li>• Bleach</li> <li>• 70 % alcohol or methylated spirit</li> <li>• Distilled water</li> <li>• Labelling marker</li> </ul> </li> <li>• Optional: sterile pipettes for sample processing</li> <li>• Laboratory coat,</li> <li>• Non - powdered gloves</li> </ul>

- |  |  |
|--|--|
| <ul style="list-style-type: none"><li>• Instructions to import ADF into GeneXpert software</li><li>• Instructions for Use (Package Insert)</li></ul> |  |
|--|--|

#### **8.4.9 Storage and Stability.**

DBS cards may be stored at 18–30 °C for 30 days or – 15°C - 20 °C or colder for up to 4 months, or -70 °C for longer storage.

EDTA-anticoagulated WB may be stored at 31–35 °C for up to 8 hours, 15–30 °C for up to 24 hours or at 2–8 °C for up to 72 hours, prior to preparing and testing the sample.

#### **8.4.10 Safety**

- i. Treat all biological samples, including used cartridges, as if capable of transmitting infectious agents.
- ii. Wear protective disposable gloves, laboratory coats, and eye protection when handling samples and reagents. Wash hands thoroughly after handling samples and test reagents.
- iii. Follow safety procedures for working with chemicals and handling biological samples.
- iv. When processing more than one sample at a time, open only one cartridge; add sample and close the cartridge before processing the next sample. Change gloves between samples.
- v. Do not substitute HIV-1 Qual assay reagents with other reagents.
- vi. Do not open the HIV-1 Qual assay cartridge lid except when adding the Sample Reagent and WB or the Sample Reagent treated DBS sample.
- vii. Do not use a cartridge if it appears wet or if the lid seal appears to have been broken.
- viii. Do not shake the cartridge. Shaking or dropping the cartridge after opening the cartridge lid may yield invalid results.
- ix. Do not use a cartridge that has a damaged reaction tube.
- x. Each single-use HIV-1 Qual assay cartridge is used to process one sample. Do not reuse spent cartridges.
- xi. The single-use disposable pipette is used to transfer one sample. Do not reuse spent disposable pipettes.
- xii. In the event of contamination of the work area or equipment with sample or control materials, disinfect the area with a 1:10 bleach solution and then 70% ethanol. Wipe work surfaces dry completely before proceeding.

#### **8.4.11 Calibration**

You do not need to calibrate the GeneXpert Dx instrument. Cepheid performs all of the necessary calibrations before you receive the system. However, Cepheid recommends that the instrument be recalibrated after 1 year of use, based on the initial installation date (or based on the previous calibration for subsequent years) or at 2000 tests per instrument module, whichever comes first.

### 8.4.12 Quality control

Quality control is an important part of *in vitro* diagnostic testing because it ensures you are performing the tests correctly and that your GeneXpert Dx System is working properly. The GeneXpert Dx System automatically performs internal quality control for each sample. During each test, the system uses one or more of the following controls:

- **Internal control (IC)**—Verifies the performance of the PCR reagents and prevents a false negative result. The internal control PCR assay assesses if there is any inhibition, possibly by components, in the test sample. The internal control is provided in the cartridge and should be positive in a negative sample.
- **Endogenous control (EC)**—Normalizes targets and ensures sufficient sample is used in the test. Because of its low variability, the endogenous control can also be used to indicate sample-inhibitor contamination. The endogenous control is taken from the sample sample.

Each test includes a Sample Volume Adequacy (SVA), a Sample Processing Control (SPC) and Probe Check Control (PCC).

**Sample Volume Adequacy (SVA):** Ensures that the sample was correctly added to the cartridge. The SVA verifies that the correct volume of sample has been added in the sample chamber. The SVA passes if it meets the validated acceptance criteria. If the SVA does not pass, an ERROR 2096 will display if there is no sample or an ERROR 2097 if there is not enough sample. The system will prevent the user from resuming the test.

**Sample Processing Control (SPC):** Ensures that the sample was correctly processed. The SPC is an Armoured RNA in the form of a dry bead that is included in each cartridge to verify adequate processing of the sample virus. The SPC verifies that lysis of HIV-1 has occurred if the organism is present and verifies that the sample processing is adequate. Additionally, this control detects sample-associated inhibition of the RT-PCR reaction. The SPC should be positive in a negative sample and can be negative or positive in a positive sample. The SPC passes if it meets the validated acceptance criteria.

In addition to the controls, the GeneXpert Dx instrument performs a probe check during the first stage of the test.

**Probe Check Control (PCC):** Before the start of the PCR reaction, the GeneXpert Instrument System measures the fluorescence signal from the probes to monitor bead rehydration, reaction tube filling, probe integrity, and dye stability. The PCC passes if it meets the validated acceptance criteria.

**External Controls:** Internal quality controls should be done weekly by using known HIV-1 DETECTED and HIV -1 NOT DETECTED as the same as the routine EID/DBS samples.

### 8.4.13 Procedural steps

Follow the actions described step by step to do each specific task

### ***Start-up the GeneXpert instrument***

- Turn on the GeneXpert Dx instrument, and then turn on the computer.
- On the Windows desktop, double-click the GeneXpert Dx shortcut icon.
- Log on to the GeneXpert Dx System software using your user name and password.
- Click on “CHECK STATUS” and check if modules are available. If not proceed to “Troubleshooting” in User manual.

***Note: Before start processing the sample, check that the GeneXpert instrument is functioning and the modules are available.***

### ***Preparing of cartridge(s) for EDTA anticoagulated Whole Blood***

- i. Wear protective disposable gloves.
- ii. Disinfect the work area by 0.5 % bleach solution followed by 70 % alcohol
- iii. Wear protective disposable powder free gloves.
- iv. Label the Sample Reagent vial with the sample identification.
- v. Inspect the test cartridge for damage. If damaged, do not use.
- vi. Open the cartridge lid.
- vii. Use the 1 mL transfer pipette provided to transfer 750  $\mu$ L of the sample reagent into the sample chamber of the cartridge.
- viii. Allow the Sample Reagent to adjust to room temperature and mix the bottle by inverting before transferring to the cartridge. Transfer exactly 750  $\mu$ L into the sample chamber of the cartridge.
- ix. Mix the Whole Blood sample by inverting the vial (EDTA or lavender-top tube) at least seven times. Immediately transfer 100  $\mu$ L using the micropipette provided by squeezing the upper bulb and then releasing to aspirate the blood.
- x. Squeeze again to dispense the blood into the sample chamber of the cartridge where it will mix with the Sample Reagent already in the sample chamber. Alternatively, use an automatic pipette to dispense the blood into the sample chamber of the cartridge. Do **NOT** pour the sample into the chamber!

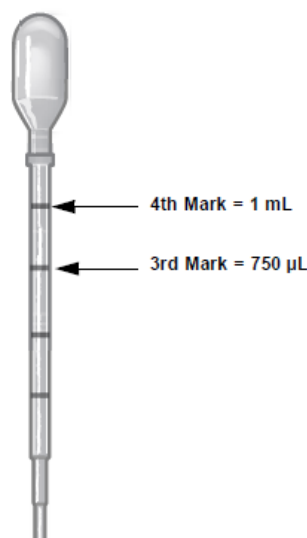

Figure 13: HIV-1 Qual Assay 1 mL Transfer Pipette

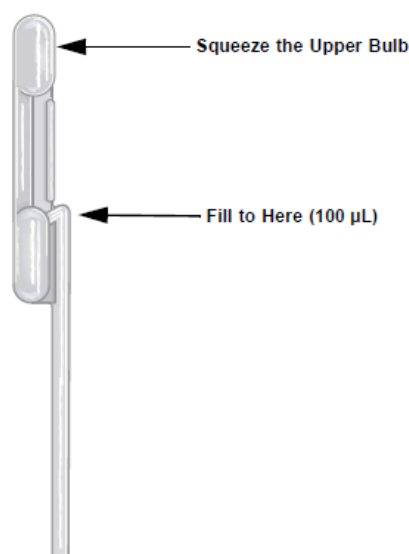

Figure 14: HIV-1 Qual Assay 100 µL Transfer Micropipette



Figure 15: HIV-1 Qual Assay Cartridge (Top View)

### **DBS sample**

- i. Wear protective disposable gloves.
- ii. Disinfect the working area.
- iii. Wear protective disposable powder free gloves.
- iv. Before starting, remove the vial containing the Sample Reagent from the kit and, if it was refrigerated, allow to adjust to room temperature. If the vial has not been stored in an upright position, make sure the buffer is settled in the bottom by giving the vial a firm shake.
- v. Turn on Thermo Mixer to heat to 56 °C.
- vi. Label the Sample Reagent vial with the sample identification.
- vii. Using sterilized scissors, excise one entire DBS from the filter paper card for each sample. Follow the delineated lines when excising the DBS. If perforated circles are used, use clean and sterile pipette tips to detach the DBS.



- viii. Unscrew the lid on the vial containing the Sample Reagent and place one DBS in the vial. Ensure that the DBS is fully submerged in the Sample Reagent buffer.
- ix. Place the vial with the DBS in a Thermo Mixer and incubate for 15 minutes at 56 °C while rotating at 500 rpm.
- x. Inspect the test cartridge for damage. If damaged, do not use.
- xi. Open the cartridge lid
- xii. Use the 1 mL transfer pipette provided to transfer all the liquid from the lysed DBS sample into the sample chamber of the cartridge. Ensure the pipette is filled above the third mark on the transfer pipette. Avoid suction of the DBS with the pipette. Do **NOT** pour the sample into the chamber!
- xiii. Close the cartridge lid, ready to start the test.

**Notes Change gloves between sample, and each new procedure.**

### **Starting the Test**

- i. In the GeneXpert System window, click **Create Test**. The scan Cartridge Barcode dialog box appears.
- ii. Scan the barcode on the HIV-1 Qual assay cartridge.
- iii. Using the barcode information, the software automatically fills the boxes for the following fields: Select Assay, Reagent Lot ID, Cartridge SN, and Expiration Date.
- iv. Type the Patient ID, make sure the Patient ID is typed correctly.
- v. Type in the **Sample ID**. Make sure the Sample ID is typed correctly.
- vi. Open the instrument module door with the blinking green light and load the cartridge.
- vii. Click **Start Test** (GeneXpert Dx). Enter you're your user name and password, if requested.
- viii. Close the door.
- ix. The test starts and the green light stops blinking. When the test is finished, the light turns off.
- x. Wait until the system releases the door lock before opening the module door and removing the cartridge.

#### **8.4.14 Biological Reference Intervals.**

Not Applicable.

#### **8.4.15 Interpretation and reporting of Results**

The results are interpreted automatically by the GeneXpert Instrument System from measured fluorescent signals and embedded calculation algorithms and are clearly shown in the View Results window. Possible results are shown in Table below:

<b>Result</b>	<b>Interpretation</b>
<b>HIV-1 DETECTED</b> See Figure 1.	The HIV-1 target nucleic acids are detected. • The HIV-1 target nucleic acids have a Ct within the valid range.

	<ul style="list-style-type: none"> <li>• SPC: NA (not applicable); SPC is ignored because the HIV-1 target amplification occurred.</li> <li>• Probe Check: PASS; all probe check results pass.</li> </ul>
<b>HIV-1 NOT DETECTED</b> See Figure 2.	<p>The HIV-1 target nucleic acids are not detected. SPC meets acceptance criteria.</p> <ul style="list-style-type: none"> <li>• SPC: PASS; SPC has a Ct within the valid range.</li> <li>• Probe Check: PASS; all probe check results pass.</li> </ul>
<b>INVALID</b>	<p>Presence or absence of the HIV-1 target nucleic acids cannot be determined. Repeat test with new sample and cartridge.</p> <ul style="list-style-type: none"> <li>• SPC: FAIL; SPC Ct is not within valid range.</li> <li>• Probe Check: PASS; all probe check results pass</li> </ul>
<b>ERROR</b>	<p>Presence or absence of HIV-1 target nucleic acids cannot be determined. Repeat test with new sample and cartridge.</p> <ul style="list-style-type: none"> <li>• HIV-1: NO RESULT</li> <li>• SPC: NO RESULT</li> <li>• Probe Check: FAIL*; all or one of the probe check results fail.</li> </ul> <p>*If the probe check passed, the error is caused by the maximum pressure limit exceeding the acceptable range or by a system component failure.</p>
<b>NO RESULT</b>	<p>Presence or absence of HIV-1 target nucleic acids cannot be determined. Repeat test with new sample and cartridge.</p> <p>A NO RESULT indicates that insufficient data were collected. For example, the operator stopped a test that was in progress.</p> <ul style="list-style-type: none"> <li>• HIV-1: NO RESULT</li> <li>• SPC: NO RESULT</li> <li>• Probe Check: NA (not applicable).</li> </ul>

**Test Result**   **Analyte Result**   **Detail**   **Errors**   **History**   **Support**  
**Assay Name** Xpert HIV-1 Qual   **Version** 1  
**Test Result** **HIV-1 DETECTED**  
 For In Vitro Diagnostic Use Only.

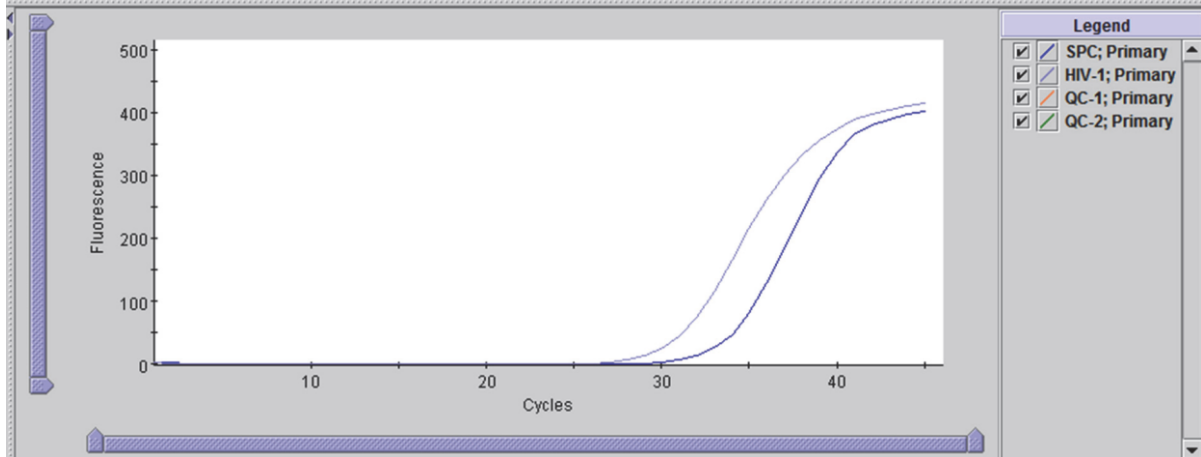

**Test Result**   **Analyte Result**   **Detail**   **Errors**   **History**   **Support**  
**Assay Name** Xpert HIV-1 Qual   **Version** 1  
**Test Result** **HIV-1 NOT DETECTED**  
 For In Vitro Diagnostic Use Only.

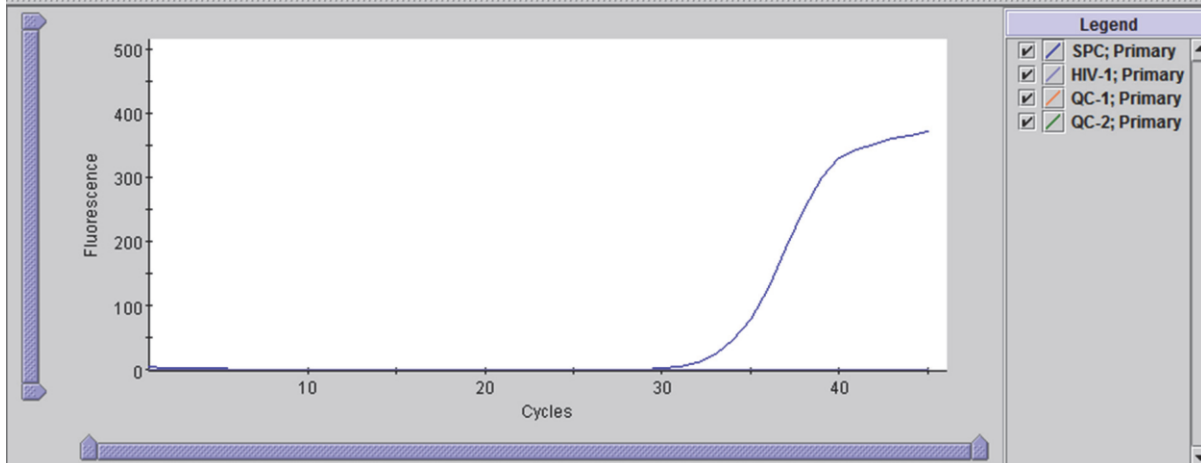

**8.4.16 Limitation of the Procedure and Sources of Error.**

Good laboratory practices and changing gloves between handling samples are recommended to avoid contamination of reagents.

Rare mutations within the target region of the HIV-1 Qual assay may affect primer and/or probe binding resulting in failure to detect the virus.

A negative test result does not preclude HIV-1 infection. Results from the HIV-1 Qual assay should be interpreted in conjunction with clinical presentation and other laboratory markers

#### **8.4.17 Performance Characteristics**

Refer to the manufacture package insert for detailed information on Performance Characteristics of the testing procedure.

#### **8.4.18 Supporting Documents**

Sample collection manual, Quality manual

#### **8.4.19 References**

Ministry of Health, Community Development, Gender, Elderly and Children, Standard Operating Procedures for qualitative HIV-1 HEID testing using GeneXpert

Xpert HIV-1 Qual -1 Assay Package Insert 308-3048 Rev J

GeneXpert Dx System. Operator Manual

## **8.5 DETERMINATION OF HIV-1 VIRAL LOAD BY USING COBAS AMPLIPREP/COBASTAQMAN (CAP/CTM) 96**

### **8.5.1 Purpose**

This procedure provides instruction on how to perform HIV-1 RNA (Viral Load test) by using The COBAS Ampliprep/COBAS Taqman 96 analyser.

### **8.5.2 Scope**

Used in PCR section for processing HIV-1 RNA (Viral Load.)

### **8.5.3 Responsibility**

Qualified and trained Medical Laboratory Practitioners are responsible for implementing this test procedure.

### **8.5.4 Principle**

The COBAS Ampliprep/COBAS Taqman HIV-1 test, is a nucleic acid Amplification test for the quantitation of human Immunodeficiency virus type 1(HIV-1) and is based on three major processes .

Sample preparation to isolate HIV-1 RNA. Reverse transcription of the target RNA to generate complimentary DNA (cDNA).

Simultaneous PCR amplification of target cDNA and detection of cleaved dual labelled oligonucleotide detection probe specific to the target.

The COBAS Ampliprep/COBAS Taqman HIV-1 test permit automated sample preparation followed by automated reverse transcription, PCR Amplification and detection of HIV-1 target RNA and HIV-1 quantitation standard (QS) Armored RNA

The master mix reagent contains primers and probes specific for both HIV-1 RNA and HIV-1 QS RNA. The master mix has been developed to ensure equivalent quantitation of group **M** subtypes of HIV-1 and of HIV-1 group **O**.

The detection of amplified DNA is performed using target specific dual-labelled oligonucleotide probes that permit independent identification of HIV-1 amplicon and HIV-1 QS amplicon.

### **8.5.5 Sample Requirements**

Venous blood collected in EDTA tube.

### **8.5.6 Equipment**

- Vortex mixer, COBAS Ampliprep instrument, COBAS Taqman 96 analyzer.
- AMPLILINK software version 3.4.0.1404, Data station for the Amp. AMLILINK software with printer, AMPLILINK software v 3.4.0.1404 series manuals

### 8.5.7 Materials

Reagent	Consumables
H12CAP Reagent kit COBAS Ampliprep/COBAS Taqman wash reagent Sample input tubes with barcode clips K-tubes	Sample racks. SPU rack K-carrier K-Carrier racks Pipettes with aerosol barrier Disposable gloves Ethanol 70 0.5 sodium hypochlorite

### 8.5.8 Storage and Stability

Store Whole Blood at 2-8 C for not longer than 24 hours, plasma sample may be stored at 2-8 C for up to five days, 60 days at -20 C, and for longer storage at -80 C.

### 8.5.9 Safety

- Decontaminate working surfaces twice daily, in the morning and afternoon
- Adhere to safety precautions as stated in the Safety manual
- All personal protective equipment (PPE) must be worn when performing this procedure.
- All samples must be regarded as potentially infectious.
- Refer to National infection prevention and control Guidelines for health waste management and safety practice.
- Avoid any contact between hands and eyes and nose during sample collection and testing.
- All spills should be wiped thoroughly using 1% sodium hypochlorite solution.

### 8.5.10 Calibration

Not Applicable

### 8.5.11 Quality Control

Run manufacturers controls for each run

### 8.5.12 Procedure Steps

- Power ON AMPLILINK Data station and monitor computer and printer. by entering USER name and password
- Log on AMPLILINK software by entering user ID and password

#### Start with daily maintenance.

- Check wash reagent reservoir (replace if necessary).
- Empty waste

**Perform maintenance:** Click on system and select CAP, Status-due tab-Perform.

#### **COBAS Taqman 96 Analyser.**

**Perform maintenance:** Click on a system and select CTM, Status-Due tab – Perform.

- i. Load Reagent, Consumables and Samples On Cobas Ampliprep.
- ii. All reagent cassettes should be removed from 2-80C storage, immediately load onto the COBAS Ampliprep and allow equilibrating to ambient temperature on the instrument for at least 30 minutes before the first sample is to be processed.
- iii. Do not let reagent cassettes come to ambient temperature outside the instrument as condensation may form on the barcode labels. Do not wipe off condensation if it appears on the barcode labels.
- iv. Place HIV-1 QUAL CSI (MPG) onto a reagent rack and load it on position 'A' of the COBAS Ampliprep.
- v. Place HIV-1 QUAL 2, HIV-1 QUAL 3 and HIV-1 QUAL 4 on the same reagent rack and load onto position B, C, D, or E'.
- vi. Position **F,G and H** is for loading samples racks
- vii. Place Sample processing units (SPUs) in the SPU racks and load the rack on position **J,K, or L** of the COBAS Ampliprep
- viii. Load K-tips on position **M and N**
- ix. Load K-carrier rack on position **O,P**

### ***Ordering and Loading of Samples***

Prepare sample racks by attaching a barcode label clip to each sample rack position where a sample (S- tube) is to place (from **position 3 to 24**). Attach one of the specific barcode label clip for the control **HPC, LPC and NC** (Position 1 to 3 respectively). The barcode label clip should have the same control lot number as the lot number on the control vial in the kit.

Using Amplilink software creates sample orders for each sample and control in the order window folder. Go to new then Select HI2CAP ,enter rack number, kit information and start ordering control and sample then complete by saving. Print sample rack order report to use as a worksheet.

Vortex each sample and control for 3-5 seconds.

Transfer 1000-1050UI for each sample and control to the appropriate barcode labelled input using a micropipette with an aerosol barrier or positive displacement RNase free tip. Avoiding transferring particulate or fibrin clot from the original sample to input S-tube. Avoiding contaminating the upper part of the S-tube with sample or controls..

Load the sample rack in position **F, G or H of the COBAS Ampliprep**. Start the COBAS Ampliprep using the Amplilink software. Then check the run end time.

After completion of the run, the samples will be transferred automatically to Taqman 96 via docking station , check the time when it finish.

Remove waste from the COBAS Ampliprep instrument

Remove reagent and put in the fridge

Accept results and print.

### **8.5.13 Biological reference Interval**

Not applicable

### **8.5.14 Interpretation and Reporting of Results**

- Target not detected- Report results **as HIV-1 RNA not detected.**
- <20cp/ml – RNA detected less than 20 HIV-1 RNA cp/ml
- >20 and <700,000 cp/ml –calculated result greater than or equal to 20 copies/ml and less than or equal to 700,000 copies /ml.
- >700,000 cp/ml-are above the range of the assay report result as greater than 700,000 HIV -1 RNA cp/ml
- Target not detected-Ct value for HIV-1 above the limit for the assay or no Ct value for HIV-1 obtained. Report results **as HIV-1 RNA not detected.**
- <20cp/ml –calculated copies are below the limit of detection of the assay report result a **HIV-1 RNA detected less than 20 HIV-1 RNA cp/ml**
- <20 and >700,000 cp/ml –calculated result greater than or equal to 20 copies/ml and less than or equal to 700,000 cp/ml are within linear range of the assay. Report results **as actual calculated number of virus.**
- >700,000 cp/ml-are above the range of the assay report result as greater than **700,000 HIV -1 RNA cp/ml**

### **8.5.15 Limitations of the procedure.**

- Good laboratory practices and changing gloves between handling samples are recommended to avoid contamination of reagents.
- Rare mutations within the target region of the HIV-1 Qual assay may affect primer and/or probe binding resulting in failure to detect the virus.
- A negative test result does not preclude HIV-1 infection. Results from the HIV-1 Qual assay should be interpreted in conjunction with clinical presentation and other laboratory markers.
- This test has been validated for use with only human plasma collected in EDTA anticoagulant. Testing of other sample types may result in inaccurate results.
- Reliable results are dependent on adequate sample collection, transport, storage and processing procedures.
- Use of this product should be limited to personnel trained to the techniques of PCR

### **8.5.16 Performance Characteristics**

Refer to method verification report of this procedure.

### **8.5.17 Supporting Documents.**

Sample collection manual, Quality Manual

### **8.5.18 References**



- Ministry of Health, Community Development, Gender, Elderly and Children, Standard Operating Procedures for qualitative HIV-1 HEID testing using GeneXpert
- Xpert HIV-1 Qual -1 Assay Package Insert 308-3048 Rev J
- GeneXpert Dx System. Operator Manual

## **8.6 DETERMINATION OF HIV EARLY INFANT DIAGNOSIS BY USING COBAS AMPLIPREP/TAQMAN**

### **8.6.1 Purpose**

This procedure provides instructions for automated HEID/DBS sample extraction, detection and amplification using Cobas AmpliPrep/TaqMan 96.

### **8.6.2 Scope**

This procedure is applicable to Molecular section

### **8.6.3 Responsibility**

Qualified and competent Medical Laboratory practitioner are responsible for implementing this procedure.

The Head of section is responsible for ensuring the effective implementation and maintenance of this procedure.

### **8.6.4 Principle**

The COBAS AmpliPrep/COBAS TaqMan HIV-1 Test is based on three major processes:

sample preparation to isolate HIV-1 RNA; reverse transcription of the target RNA to generate complementary DNA (cDNA), and Simultaneous PCR amplification of target cDNA and detection by use of a cleaved dual-labelled oligonucleotide detection probe specific to the target.

### **8.6.5 Sample Requirements**

Dried Blood Spot

### **8.6.6 Equipment**

COBAS AmpliPrep Analyser 96

COBAS TaqMan Analyser 96

Biological safety Cabinet (BSC)

Thermomixer

### **8.6.7 Materials**

#### **Reagents**

SPEX, HIV-1 QL v2.0 CS1 (Magnetic Glass Particles Reagent Cassette), HIV-1 QL v2.0 CS2 (Lysis Reagent Cassette), HIV-1 QL v2.0 CS3 (Multi-Reagent Cassette), HIV-1 QL v2.0 CS4 (HIV-1 Test-Specific Reagent Cassette), HIV-1 QS (HIV

Quantitation Standard), HIV-1 MMX (HIV-1 Master Mix), 70% Ethanol, CAP/CTM Manganese Solution, Wash Reagent (PG WR), Freshly prepared 0.5% Bleach

### **Consumables**

Sample processing units (SPUs), Sample input tubes (S-tubes) with barcode clips, Racks of K-tips, K-tube Box of (12 x 96), Sample Rack (SK 24 rack), Reagent Rack, SPU rack, K-carrier, Disposable powder free gloves, Biohazard disposable bags, Pipettes and appropriate tips, Laboratory coat, CTM (-) C (Negative Control) and Barcode clip, HIV-1 H (+) C (Positive Control) and Barcode clip

### **8.6.8 Storage and Stability**

Store DBS in room temperature for longer storage store in -80°C

### **8.6.9 Safety**

- Wear protection clothing such as a laboratory coat, disposable gloves when performing this procedure.
- All samples must be regarded as potentially infectious, safety procedures must be followed. Pre-amplification procedures must be kept separate from post-amplification procedures. Do not bring amplified samples into the pre-amplification area. Amplified controls and samples should be considered a major source of potential contamination.

### **8.6.10 Calibration**

Not applicable

### **8.6.11 Quality Control**

- Use manufacturer Positive and Negative controls for each run
- Run known patient samples once a month and every time when you change reagent lot (lot to lot verification)
- Do not run patient's samples when control fails.
- The CTM (-) C (Negative Control) must yield a "NEGATIVE" result or run will be invalid. The CTM (+)C (Positive control) must yield a "POSITIVE" results. These assigned values can only be printed while the TaqMan is running. A printout of the assigned ranges will be posted in the laboratory for each lot and assigned ranges will be included with results.

### **8.6.12 Procedural Steps**

#### **8.6.12.1 AmpliPrep Pre Extraction**

- i. Switch on Biosafety Cabinet then wipe it with 0.5% Bleach solution followed by 70% ethanol.
- ii. Ensure that respective EID/DBS samples are ready to be processed.
- iii. Remove AmpliPrep kit from refrigerator in order to warm before starting using it.
- iv. Turn "ON" the Computer System. Enter User name and Password;

- v. Double-click AMPLILINK software icon. Enter User name and Password;
- vi. Click the Status icon and select the AmpliPrep instrument from drop-down menu.
- vii. Click the System tab to check supply of PG WR and disposables (SPUs, K-tips).
- viii. Click the Service icon and click the Due tab. Click on Daily Maintenance and click Perform. Utilizing the screen wizard, perform required maintenance and document on maintenance chart.
- ix. Click on the Status icon and click the Cassette/Samples tab to view reagent status.
- x. Place HIV-1 QL v2.0 CS1 on a reagent rack (barcode faces to the right), and load into instrument position A. Load reagents onto AmpliPrep approximately 30 minutes prior to use for adequate warming and mixing.
- xi. Place HIV-1 CS2, HIV-1 CS3 and HIV-1 CS4 on a reagent rack, and load into instrument position B, C, D, or E approximately 30 minutes prior to use for adequate warming and mixing. Do not let reagent cassettes come to ambient temperature outside the instrument.
- xii. Place SPUs in SPU rack (Roche logo facing back, SPUs to the right), and load into position J, K, or L.
- xiii. Load appropriate number of full K-tip racks (one K-tip is needed for each sample to be run) into instrument position M-P. Do not remove "in use" (partially used) K-tip racks from the platform.
- xiv. Load K-tubes rack into AmpliPrep positions M-P. Do not remove "in use" (partially used) K-tube racks from the platform.
- xv. Attach a control barcode label clip to sample rack positions in any arrangement as long as they take first two positions.
- xvi. Attach a barcode label clip to each sample rack position where a sample (S-input tube) is to be loaded. Check the seating of the clips into the rack, positive ID of samples is maintained by manually linking sample IDs with clip barcodes which are read by the AmpliPrep.

***Using work list, create Sample-Rack Order using AMPLILINK software;***

- i. Click ORDERS icon.
- ii. Click sample rack tab.
- iii. Click the "NEW" button.
- iv. Click test HI2QLD96 for testing DBS.
- v. Click where there's a tick for Docked (This makes sure laboratory personnel uses docked system as required in CAP/CTM 96)
- vi. Click S in positions 1-2 to access pull-down menu and assign controls.
- vii. Enter sample Names or IDs.
- viii. Click SAVE button.
- ix. Use tips to punch DBS samples, use single tip for single DBS sample. Punch DBS samples respectively into the S-tube from third position of the sample rack choose the best circle which is well filled with sample and avoid contamination while punching.
- x. Then transfer 1100  $\mu$ L of SPEX to each S-tube containing DBS punched circle.

- xi. Then transfer 1000 µL of positive control and negative control respectively into first and second position of sample rack.
- xii. Take finished prepared DBS sample rack into the thermo mixer and arrange S-tube accordingly. Set 56 degree centigrade and 1000 rpm to allow samples for pre extracted within 10min using stop watch.
- xiii. Thereafter remove sample arrange them back into the sample rack start from positive control negative control and samples respectively.
- xiv. Load sample rack with clips attached into AmpliPrep to position F, G or H and clip numbers will appear. Click print icon (CTRL+P).
- xv. The machine will start automatically if not start the run by pressing START on the System status page of the AMPLILINK software.
- xvi. Upon completion of AmpliPrep sample preparation, the docking station will transport K-carrier with processed samples automatically into the TaqMan for amplification and quantification.
- xvii. If you didn't click on docked system, the K-tubes with the processed samples will be taken to the sample rack. You'll be needed to transfer manually the rack into the TaqMan for the next procedure.
- xviii. If reagent cassettes have remaining reagent as noted on system Status screen, remove cassettes and place in refrigerator in box labeled with tests remaining, initials, and date used.
- xix. Remove and discard waste from COBAS AmpliPrep instrument.

#### **8.6.12.2 Amplification and Detection**

Using the system selection box icon on the AMPLILINK, select COBAS TaqMan. Check status of thermal cyclers A, B, C and D.

Samples transferred from the Ampliprep will automatically start to be tested in the TaqMan. When finished testing the machine will dispose used K-tubes into the special bin inside it. Empty K-carrier will then be placed on the right side.

At the completion of the COBAS TaqMan 96 Analyser run, review Results Report for each rack by clicking the RESULTS icon (F8)  REVIEW tab  clicking on Rack ID.

#### **8.6.13 Biological Reference Intervals**

Not applicable

#### **8.6.14 Interpretation and Reporting of Results**

If one or both of the controls are flagged as invalid or is out of range, then the entire batch is invalid. Repeat the entire process from extraction, amplification and detection. If repeat testing is required due to QC failure, or equipment failure, record such problems in the CA log and generate an occurrence report.

possible result cases are generated:

##### **Invalid**

- a) Failure or abort during titre calculation. Result calculation is not possible.

b) Following a control failure the whole batch is set to “Invalid” (according to control failure handling settings in the AMPLILINK software).

### **Failed**

Preparation on the COBASR AmpliPrep Instrument failed.

**Positive** DBS DETECTED for positive result repeat the test to confirm with other DBS card

**Negative** DBS NOT DETECTED

If sample results are deemed valid after QC review, they may be entered into register book.

### **8.6.15 Limitation of the Procedure and Sources of Errors**

- This test has been developed for use with HIV viral load, EDTA plasma and human whole Blood samples collected in EDTA anticoagulants. Testing of other sample types may result in false negative or false positive results. Heparin inhibits PCR; Samples collected using heparin as the anticoagulant should not be used within the Cobas Ampliprep Taqman HIV-1 Test.
- Reliable results are dependent on adequate samples collection, transport, storage and processing procedures
- The presence of Ampere enzyme in Cobas Ampliprep/Taqman HIV-1 master mix reduces the risk of amplicon contamination
- Detection of HIV -1 is dependent on the amount of viral RNA and proviral DNA in the sample and may be affected by sample collection methods, patient factors (ie .,age ,presence of symptoms)and/or stage of infection
- False negative results may occur due to polymerase inhibition .The HIV-1 IC has been added to the Cobas Ampliprep/Cobas Taqman HIV-1 Test to permit the identification of the processed samples containing substances that may interfere with PCR amplification
- Use of this product should be limited to personnel trained in technique of PCR
- Due to inherent differences between technologies, it is recommended that prior to switching from one technology to the next ,users perform method correlation studies in their laboratory to qualify technology differences

Movement in PCR section should be uni-direction to avoid contamination.

### **8.6.16 Performance Characteristics**

Refer to method verification report

### **8.6.17 Supporting Documents**

Safety SOP, Laboratory equipment SOP

### **8.6.18 References**

- i.** COBAS® Ampliprep® / COBAS® Taqman® HIV-1 Test Package Insert, 09/2005, Rev3.0
- ii.** COBAS® Ampliprep® / COBAS® Taqman® HIV-1 Test Laboratory Procedure Manual, Rev05/07.
- iii.** COBAS® Ampliprep® Instrument Operator's Manual, 03/2003, Version 1.0.
- iv.** COBAS® Taqman Operator's Manual, 03/2003, Version 1.0.
- v.** Manufacture Package Insert ©2010 Roche Molecular Systems Inc

## **8.7 DETERMINATION OF HIV-1 VIRAL LOAD BY USING COBAS (CAP/CTM) 6800/8800**

### **8.7.1 Purpose**

Nucleic acid amplification test for the quantification of Human Immunodeficiency Virus type 1 (HIV-1) RNA in human plasma.

### **8.7.2 Scope**

Used in PCR section for processing HIV-1 RNA (Viral Load.)

### **8.7.3 Responsibility**

Qualified and trained Medical Laboratory Technicians, Technologists and Scientists are responsible for implementing this test procedure

The Head Microbiology is responsible for ensuring the effective implementation and maintenance of this procedure.

### **8.7.4 Principle**

The Cobas 6800 HIV-1 assay is based on fully automated sample preparation (nucleic acid extraction purification and stabilization) followed by PCR amplification and detection. The Cobas 6800/8800 System consists of four modules namely the sample supply, transfer, processing, and analytical modules.

**The sample supply module** consists of the normal and priority lanes which are used for loading racks for samples and clotted tubes as well as loading and transporting prioritized racks and sample tubes respectively. It also consists of the error lane which is used to unload error racks and samples.

**The transfer module** is responsible for loading and unloading reagent and control cassettes, tip racks, store loaded reagents and controls in an on board refrigerator (2-8° C) and sample identification through their barcodes. It also consists of the sample pipettor and transfer module handler which is used to pipette samples and controls to the processing plate (always controls first).

**The processing module** performs sample preparation and PCR setup for the subsequent amplification and detection. It consists of different units; the reagent Transfer Head, processing Transfer Head (two 48-head pipettors), processing Module Handler, the sealing Station, and an interim reagent storage where reagents transferred from the on board storage unit are stored. It is in this unit where magnetic glass particles (MGP) cassette is transferred to the shaker. The reagent transfer head is responsible for adding reagents to processing plate while the processing transfer head mixes and wastes contents of the processing plate and transfers eluate from processing plate to amplification plate. The reagent cassettes needed for sample preparation and for the next run are stored in the interim storage compartment at a temperature below 25° C and can hold up to a total of 6 cassettes (2 per assay) for Cobas 6800 and the numbers doubles up for Cobas 8800 since it has two processing modules.



**The analytical module** performs automated amplification and detection in real time PCR. Consists of 1 and 2 analytic cyclers unit(s) for Cobas 6800 and Cobas 8800 respectively and amplification plate handle, airlock separation of analytic module from the other sample handling and preparation areas as well as dedicated output port (magazine) for manual removal of amplification plate at the end of the PCR cycle.

Nucleic acids from patient samples, external controls, and RNA Quantification Standard (QS) molecules are simultaneously extracted. In summary, viral nucleic acids are released by addition of proteinase and lysis reagent to the sample. The released nucleic acids bind to the silica surface of the added magnetic glass particles. Unbound substances and impurities, such as denatured proteins, cellular debris and potential PCR inhibitors are removed with subsequent wash reagent steps and purified nucleic acids are eluted from the magnetic glass particles with elution buffer at elevated temperatures.

Cobas 6800/8800 HIV-1 reagent cassette contains proteinase solution, quantitation standard (QS), Elution buffer and Master Mix reagents 1 and 2. The Master Mix solutions contains two detection probes specific for the HIV-1 target sequences and one for RNA QS. The probes are labelled with target specific fluorescent reporter dyes allowing simultaneous detection of HIV-1 target and RNA QS in two different detection channels. When not bound to the target sequence, the fluorescent signals of the intact probes are suppressed by a quencher dye. During the PCR amplification step, hybridization of the probes to the specific single-stranded DNA template results in cleavage of the probe by the 5' to 3' exonuclease activity of the DNA polymerase resulting in separation of the reporter and quencher dyes and the generation of a fluorescent signal. With each PCR cycle, increasing amounts of cleaved probes are generated and the cumulative signal of the reporter dye increases concomitantly. Real-time detection and discrimination of PCR products is accomplished by measuring the fluorescence of the released reporter dyes for the viral targets and RNA QS, respectively.

Selective amplification of target nucleic acids from the sample is achieved using target virus-specific forward and reverse primers which are selected from highly conserved regions of HIV. The HIV-1 gag gene and the HIV-1 LTR region (dual target) are amplified. Selective amplification of RNA QS is achieved using sequence-specific forward and reverse primers which are selected to have no homology with the HIV genome. A thermo-stable DNA polymerase enzyme is used for both reverse-transcription and PCR amplification. The target and RNA QS sequences are amplified simultaneously utilizing a universal PCR amplification profile with predefined temperature steps and number of cycles. The master mix includes deoxyuridine triphosphate (dUTP), instead of deoxythymidine triphosphate (dTTP), which is incorporated into the newly synthesized DNA (amplicon). Contaminating amplicons from previous PCR runs are eliminated by the AmpErase enzyme, which is included in the PCR master mix, during the first thermal cycling step. However, any newly formed amplicons are not eliminated since the AmpErase enzyme is inactivated once exposed to temperatures above 55°C.

Automated data management is performed by the Cobas 6800/8800 software which assigns test results for all tests as target not detected, <LLOQ (lower limit of quantitation), >ULOQ (upper limit of quantitation) or HIV RNA detected, a value in the

linear range  $LLoQ \leq x \leq ULoQ$ . Results can be reviewed directly on the system screen, exported, or printed

### 8.7.5 Sample Requirements

Plasma sample

### 8.7.6 Equipment

Cobas 6800/8800, Biosafety cabinet (BSC), Centrifuge, Vortex mixer, Micropipette

### 8.7.7 Materials

Reagent	Consumables
Cobas HIV-1 / cobas HBV / cobas HCV / cobas CMV	CobasomniProcessing Plate
Cobas HBV/HCV/HIV-1 Control Kit or cobas CMV Control Kit	CobasomniPipette Tips
Cobas NHP Negative Control Kit	CobasomniAmplification Plate
Cobasomni MGP Reagent	CobasomniSecondary Tube
CobasomniLysis Reagent	Solid Waste Bag
Cobasomni Sample Diluent	
Cobasomni Wash Reagent	

### 8.7.8 Storage and Stability

Store Whole Blood at 2-8 C for not longer than 24 hours, plasma sample may be stored at 2-8 C for up to five days, 60 days at -20 C, and for longer storage at -80 C.

### 8.7.9 Safety

- i. Adhere to safety precautions as stated in the Safety manual
- ii. All personal protective equipment (PPE) must be worn when performing this procedure.
- iii. All samples must be regarded as potentially infectious.
- iv. Avoid any contact between hands and eyes and nose during sample collection and testing.
- v. All spills should be wiped thoroughly using 1% sodium hypochlorite solution.

### 8.7.10 Calibration

Not Applicable

### 8.7.11 Quality Control

## Quality control and validity of results

One negative control (-) C and two positive controls, a low positive control HBV/HCV/HIV-1 L (+) C and a high positive control HBV/HCV/HIV-1 H (+) C, are processed with each batch.

In the Cobas 6800/8800 Software and/or report, check for batch validity.

Invalidation of results is performed automatically by the Cobas 6800/8800 Software based on negative and positive control failures.

### Control result interpretation

Control results are reported as valid or invalid. If any control in a batch is invalid, the entire batch is reported as invalid.

**Table 1: Control result interpretation for negative and positive controls**

Negative Control	Result	Interpretation
(-) C	Target Not detected	Control is valid. HIV-1 RNA Not detected
	Invalid	An invalid result or the calculated titre result for the negative control is not negative
Positive Control	Result	Interpretation
HBV/HCV/HIV-1 L(+) C	Titter	Control is valid. Calculated titre is within the control range.
	Invalid	An invalid result or the calculated titre result for the low positive control is not within the assigned range.
HBV/HCV/HIV-1 H(+) C	Titter	Control is valid. Calculated titre is within the control range.
	Invalid	An invalid result or the calculated titre result for the low positive control is not within the assigned range.

If the batch is invalid repeat testing the entire batch including samples and controls

### 8.7.12 12.0. Procedure

#### Workflow

- **Start-up sample supply module and unload used tubes/racks**
  - Remove rack tray with RD5/MPA racks with processed samples from output buffer (left).
  - Press **On** button (if turned off).
  - Load empty rack tray on output buffer (left).
  - Wait for initialization/unloading.
  - Remove unloaded racks.

- **Start-Up System**
  - Press the power button below the monitor (if monitor is turned off)
  - **Note:** Instrument will automatically initialize and change from **Initializing** to **Standby** status.
  - Log on software
- **Removing the used amplification Plates**
  - Choose Monitoring > Amplification Plate Drawer > Open drawer.
  - Remove all used amplification plates.
  - Close the amplification plate drawer manually.
- **Emptying Solid and Liquid Waste and Reloading Wash**
  - Choose Monitoring > Wash/Waste Drawer > Open drawer.
  - Wait for drawer to open.
  - Pull drawer, turn solid waste container to right side until it clicks into place.

#### ***Replace (or empty) Liquid Waste***

- i. Pull lower liquid waste drawer out.
- ii. Check waste levels.
- iii. Unlock waste arms by clicking **UNLOCK**
- iv. Make sure status shows Unlocked. Lift waste arm.
- v. Remove and replace waste container.
- vi. Close waste arm.
- vii. Push liquid waste drawer in.

***Note: If reusing liquid waste container, make sure no foam/bubbles is present inside.***

#### ***Empty Solid Waste***

- i. Check Solid waste level.
- ii. Remove solid waste bags from solid waste container.
- iii. Waste bags must be inserted into solid waste container.
- iv. Confirm that solid waste status is reset to 0% by clicking the “Confirm that solid waste container is empty” button.
- v. Note: If used waste bags are pierced, decontaminate solid waste container according to the User Assistance.
- vi. Replacing and loading Wash
- vii. Pull out top wash drawer.
- viii. Check wash levels.
- ix. Unlock reagent aspiration arm by clicking **UNLOCK**
- x. Pull out reagent aspiration arm Replace wash bottle.
- xi. Push reagent aspiration arm down, push wash drawer in.
- xii. Close wash/waste drawer.

#### ***Replace and load Sample Diluent and Lysis***

- i. Choose Monitoring > Bulk Reagent Drawer > Open Drawer.

- ii. Wait for drawer to open, then pull.
- iii. Check Lysis and Sample Diluent levels.
- iv. Unlock reagent aspiration arm by clicking UNLOCK
- v. LED will turn off, pull reagent aspiration arm up and turn to park position.  
(Make sure status is Unlocked before pulling arm up)
- vi. Replace bottle.
- vii. Push reagent aspiration arm down.
- viii. Close bulk reagent drawer.
  - **Note: Recommended to not leave any positions empty as aspiration filter will dry out.**
  - **Load Processing Plates, MGP cassettes, Amplification Plates**
    - Choose Monitoring > Consumable Drawer > Open Drawer.
    - Wait for drawer to open, then pull.
    - Open drawer until it clicks into place.
    - Load processing plates, MGP, amplification plates as needed.
    - Click Close drawer on software then push drawer after the CLICK.
  - **Load Tip Rack / Reagents**
    - Choose Monitoring > Reagent Cassette Drawer > Open Drawer.
    - Drawer will open slightly, pull it to fully open.
    - **Reagent Cassette**
      - Before Loading the Reagent Cassette:
      - Check the cassette visually for misaligned plastic → could lead to instrument crashes!
      - Example: A part of the (hard) plastic component of the vessel is visible from the top. Do not load/use the reagent cassette on the system.
  - **Control Cassette**
    - i. Before loading the control cassette:
    - ii. Visually inspect the control cassette from the top for misaligned mini racks
    - iii. Misaligned mini racks lead to transfer module crashes!
    - iv. If mini racks are misaligned, press the control cassette onto a flat surface before loading.
    - v. Remove empty reagent or control cassettes.
    - vi. Wait until reagent drawer is in loading position.
    - vii. Load Reagent and Control Cassettes.
  - viii. Click **Close drawer** on software then push drawer after the **CLICK**
  - ix. Load tip racks
  - x. Click **Unload empty** if needed
- **Prime System**
  - Press **Start**: Instrument will change to **Preparing** Then **Ready** status when finished. Preparing: priming fluidic system (incl. needles bent check), which takes 10-15 minutes.
- **Load clotted tip racks and samples**

- Place 5 empty sample tubes into rack (rack ID starts with an “R”), prepare 2 racks.
- Place 2 racks on empty rack tray (or can be loaded together with samples).
- Load rack tray on the input buffer of the sample module.
- \*Empty tubes are used for disposal of clotted tips and tips with pipetting error during sample aspiration to prevent cross contamination.
- **Load samples**
  - Place a rack tray with RD5 or MPA racks on the input buffer of sample supply module.
  - Wait until the barcode reading station has processed all racks.
  - Loaded racks will be placed in the transfer module for pipetting.
  - Close front cover.

### **Start Run**

- i. Choose Monitoring > Batches
- ii. Check if all required samples and Consumables are loaded.
- iii. Choose Start manually button.
- iv. If samples/controls total 96 (full batch), run starts automatically.
- v. System has 120 minutes’ counter before automatically starting non-full batches

### **Reviewing and Releasing Results**

- i. The **Cobas** 6800/8800 System automatically determines the HIV-1 RNA concentration for the samples and controls
- ii. The HIV-1 RNA concentration is expressed in copies per millilitre (cp/ml)).
- iii. Re test any sample with a failed or invaled result for any reason.
- iv. Sort the failed samples with their request forms and forwarded for retesting, once results are available will be sent back to the site of origin using the existing mechanism.
- v. If the remaining sample is not sufficient for further testing, then another sample is requested from the specific site by sending a printout from DISA which indicates that the sample did not produce the intended results.

#### **8.7.13 Biological Reference interval**

Not Applicable

#### **8.7.14 Interpretation and Reporting of Results and interpretation**

##### **Interpretation of Patient results**

Results from the HIV-1 Qual assay should be interpreted in conjunction with clinical presentation and other laboratory markers

For a valid batch, sample results are interpreted as shown in Table 2.

#### **Table 2: Target results for individual target result interpretation**

Cobas HIV-1	Result Report and interpretation
Target Not Detected	HIV RNA not detected. Report results as “Target not detected.” Or “Lower than Detectable Limit”
<Titter Min	Calculated titre is below the Lower Limit of Quantitation (LLoQ) of the assay. Report results as “HIV detected less than (Titter Min).” Titter min = 20cp/mL (for 500 µl sample input volume) Titter min = 40cp/mL (for 200 µl sample input volume)
Titter	Calculated titre is within the Linear Range of the assay – greater than or equal to Titter Min and less than or equal to Titter Max.
	Report results as “(Titter) of HIV-1 detected”.
>Titter Max*	Calculated titre is above the Upper Limit of Quantitation (ULoQ) of the assay. Report results as “HIV detected, greater than (Titter Max).”
	Titter max = 1.00E+08 cp/ml (500 µl and 200 µl)

\*Sample result >Titter Max refers to HIV-1 positive samples detected with titre above the upper limit of quantitation (ULoQ). If a quantitative result is desired, the original sample should be diluted with HIV-1 negative EDTA plasma and the test should be repeated. Multiply the reported result by the dilution factor. A sample may be reported as invalid if there is no Ct value for the Quantitation Standard (QS), if the QS Ct is out of range, or otherwise out of specification. If a sample is invalid, no titer will be reported. To ‘Export’ or ‘Print’ a result report for one target from an individual run:

Go to the Routine tab and select “Control batch”

Select the Printer icon dropdown menu.

From there, the user can export, print or preview the batch report.

Exports of the batch report can be recovered from the IG or using a remote connection.

#### **8.7.15 Limitation of the Procedure and Sources of Error**

Rare mutations within the target region of the HIV-1 Qual assay may affect primer and/or probe binding resulting in failure to detect the virus.

A negative test result does not preclude HIV-1 infection.

#### **8.7.16 Performance characteristics**

Refer to the manufacturer insert and method verification report of this procedure.

#### **8.7.17 Supporting Documents.**

- Sample collection manual, Quality Manual

#### **8.7.18 References**

- Roche C6800/8800 user training manual
- Manufacturer Insert





## 8.8 DETERMINATION OF HIV-1 VIRAL LOAD BY USING COBAS (CAP/CTM) 4800

### 8.8.1 Purpose

This procedure provides instructions for automated HIV viral load detection using Cobas 4800 analyzer

### 8.8.2 Scope

Used in PCR section for processing HIV-1 RNA (Viral Load.)

### 8.8.3 Responsibility

Qualified and trained Assistant Medical Laboratory Technologist, Technologists and Scientists are responsible for implementing this test procedure

The Head Microbiology is responsible for ensuring the effective implementation and maintenance of this procedure.

### 8.8.4 Principle

The COBAS AmpliPrep/COBAS TaqMan HIV-1 Test is based on three major processes:

Sample preparation to isolate HIV-1 RNA

Reverse transcription of the target RNA to generate complementary DNA(cDNA).

Simultaneous PCR amplification of target cDNA and detection by use of a cleaved dual-labelled oligonucleotide detection probe specific to the target

### 8.8.5 Sample Requirements

Plasma

### 8.8.6 Equipment

Perform the procedure for start-up, maintenance, troubleshooting and shut down the Cobas 4800 analyser as per manufacturer's instrument instructions

### 8.8.7 Materials

Reagent	Consumables
Cobas 4800 Sample Preparation	Cobas 4800 1ml Filtered Core-Tips (1 box has 40 racks of 96 tips each)
Cobas 4800 Lysis	Cobas 4800 AD Plate 0.3 ml
Cobas 4800 HBV/HCV/HIV-1	Cobas 4800 Extraction Plates 2.0 ml
Controls	Cobas 4800 50ml reagent reservoir
Cobas 4800 HIV-1 AMP/DET	Cobas 4800 200ml reagent reservoir
Cobas 4800 Wash Buffer	Red top vacutainer tubes or Blank vacutainer tube
	Disposable powder free gloves,
	Freshly prepared 0.5% Bleach
	Biohazard disposable bags
	70% Ethanol
	Pipettes and appropriate tips
	Laboratory coat

### **8.8.8 Storage and stability**

- DBS cards may be stored at 18–30 °C for 30 days or – 15°C - 20 °C or colder for up to 4 months, or -70 °C for longer storage.
- EDTA-anticoagulated WB may be stored at 31–35 °C for up to 8 hours, 15–30 °C for up to 24 hours or at 2–8 °C for up to 72 hours, prior to preparing and testing the sample.

### **8.8.9 Safety**

- i. Decontaminate working surfaces twice daily, in the morning and afternoon
- ii. Temperatures for the room and refrigerator are recorded twice daily, in the morning and afternoon.
- iii. Adhere to safety precautions as stated in the Safety manual
- iv. All personal protective equipment (PPE) must be worn when performing this procedure.
- v. All samples must be regarded as potentially infectious.
- vi. Refer to National infection prevention and control Guidelines for health waste management and safety practice.
- vii. Avoid any contact between hands and eyes and nose during sample collection and testing. Do not use kit beyond the expiration date which appears on the package label or device in a damaged pouch.
- viii. The test device should be stored at 2 -30.0 C. And the test should be performed at room temperature.
- ix. Do not reuse the test device.
- x. All spills should be wiped thoroughly using 1% sodium hypochlorite solution.

### **8.8.10 Calibration**

Not applicable

### **8.8.11 Quality Control**

- Run manufacturers controls (**IQC**)
- They laboratory may run External Quality Controls (**EQC**) if available/received in each run as explained on detailed procedure below

### **8.8.12 Procedure**

#### ***Loading the reagents,***

- i. Scan the barcode of the required reagent.
- ii. Scan the barcode of an unused reagent reservoir.
- iii. Pour the reagent in the scanned reagent reservoir.
- iv. Place the filled reagent reservoir onto the required position of the reagent reservoir carrier as indicated in the wizard.
- v. Pour then Load Wash Buffer (WB) and Lysis in 200mL reservoirs in the reagent rack then place it on its position (48 - 49).

- vi. Click **LOAD REAGENTS** after that Scan, Pour then Load Elution Buffer (EB) and Magnetic Glass Particles (MGP) in 50mL reservoirs then place in on its position (track 50). Click **LOAD REAGENTS** after that.
- vii. Uncap reagent vials and controls then load as required on Reagent Carrier (ensure that liquid is at the bottom and no bubbles are visible) in positions 51, 52 and 53. Between each position click **LOAD REAGENTS** before loading another reagent carrier.
- viii. After all samples, consumables and reagents are loaded successfully the run can be started. The remaining time of the **Reagent on board Stability (60 Min.) or lower** will be visible. Click **START RUN**.
- ix. After the sample preparation has finished, the racks can be unloaded. Click **UNLOAD** the analyzer will start unloading prepared samples in AD plate and all used reagents and consumables. Allow the Cobas x480 instrument to unload all the carriers. Do not pull them out manually. This would interrupt the unload process and crash the instrument. The AD plate must be transferred to the Cobas z480 within 40 minutes.
  - After the unloading is completed, seal the AD Plate manually.
  - Remove the protection layer from the sealing film.
  - Cover the AD Plate with the adhesive side of the sealing film.
  - Firmly press the sealing film to the plate surface using the sealing film applicator.
  - Remove both ends of the sealing film alongside the perforation.
  - Place the sealed MWP plate into the Extended Plate Loader on the Cobas z480 analyzer.
  - Click **NEXT** and then load the plate into z480 analyzer. As soon as the AD Plate is loaded into the z480 cycler, the **Amplification and Detection** will start automatically

**Note:** EQC may be tested when available upon client samples are tested, this may check manufacturers internal QC if are effective in identifying any problems with the testing processes.

- x. Run is not finished before the button Show results is clicked. Note: Once the Show Results button is clicked, the Control growth curves can no longer be viewed.
- xi. Click the Results tab to display the Results work area.
- xii. After the run has finished, unload the AD Plate from the z 480 analyzer as soon as practical.
- xiii. The sealing film adhesiveness may degrade with time and without pressure. Removing the AD Plate promptly minimizes any possible contamination of the z480 analyzer.

### **8.8.13 Biological Reference interval**

Not Applicable

### **8.8.14 Interpretation and Reporting of Results and interpretation**

- i. Results will be viewed as **exponential**, they'll need to be converted to normal number first before dispatched.
- ii. Target not detected-Ct value for HIV-1 above the limit for the assay or no Ct value for HIV-1 obtained. Report results **as HIV-1 RNA not detected.**
- iii. **<Titter min** –calculated copies are below the limit of detection of the assay report result a **HIV-1 RNA detected less than 20 HIV-1 RNA cp/ml**
- iv. **Titter max** –calculated result greater than or equal to 10,000,000 cp/ml are report result as **>10,000,000 HIV-1 RNA cp/ml**

#### **8.8.15 Limitation of the Procedure and Sources of Error**

- i. This test has been validated for use with only human plasma collected in EDTA anticoagulant. Testing of other sample types may result in inaccurate results.
- ii. Reliable results are dependent on adequate sample collection, transport, storage and processing procedures.
- iii. Use of this product should be limited to personnel trained to the techniques of PCR.
- iv. Communicate with clinician on the HIV 1 VIRAL LOAD panic result  $\geq 1000$  cop/mL and maintain the record of communication

#### **8.8.16 Performance Characteristics**

Refer to the manufacturer insert and method verification report of this procedure

#### **8.8.17 Supporting documents**

Sample collection manual and Safety Manual

#### **8.8.18 References**

COBAS AmpliPrep/ COBAS TaqMan HIV-1 Test Package Insert, 09/2005, rev3.0  
COBAS AmpliPrep/ COBAS TaqMan HIV-1 Test Laboratory Procedure Manual, rev05/07.  
COBAS AmpliPrep Instrument Operator's Manual, 03/2003, version 1.0.  
COBAS TaqMan Operator's Manual, 03/2003, version 1.0.

## **8.9 DETERMINATION OF HIV-1 VIRAL LOAD BY USING M2000SP/RT**

### **8.9.1 Purpose**

The Abbott Real Time HIV-1 assay is an in vitro reverse transcription polymerase chain reaction (RT-PCR) assay for the quantitation of Human Immunodeficiency Virus type 1 (HIV-1) in human plasma from HIV infected individuals. It is not intended to be used as a screening test for HIV-1 or as a diagnostic test to confirm the presence of HIV infection.

### **8.9.2 Scope**

Used in PCR section for processing HIV-1 RNA (Viral Load.)

### **8.9.3 Responsibility**

Qualified and trained Medical Laboratory practitioners are responsible for implementing this test procedure

The Head of section is responsible for ensuring the effective implementation and maintenance of this procedure.

### **8.9.4 Principle**

The Abbott Real Time HIV-1 assay uses RT-PCR to generate amplified product from the RNA genome of HIV-1 in clinical samples. An RNA sequence that is unrelated to the HIV-1 target sequence is introduced into each sample at the beginning of sample preparation. This unrelated RNA sequence is simultaneously amplified by RT-PCR and serves as an internal control (IC) to demonstrate that the process has proceeded correctly for each sample. The amount of HIV-1 target sequence that is present at each amplification cycle is measured using fluorescent-labelled oligonucleotide probes on the Abbott m2000rt instrument. The probes do not generate signal unless they are specifically bound to the amplified product. The amplification cycle at which fluorescent signal is detected by the Abbott m2000rt is proportional to the log of the HIV-1 RNA concentration present in the original sample.

### **8.9.5 Sample Requirements.**

Human plasma (ACD-A and EDTA) samples may be used with the Abbott Real Time HIV-1 assay.

### **8.9.6 Equipment**

Perform the procedure for start-up, maintenance, troubleshooting and shut down the m2000SP/RT analyser as per manufacturer's instrument instructions

### **8.9.7 Materials**

Internal control (4vials, 1.2ml per vial), Amplification Reagent Pack (4 packs, 24 tests/pack), Abbott Real Time HIV-1 Control Kit

### **8.9.8 Storage and stability**

#### **8.9.8.1 Reagent and internal quality controls**

- Thaw assay controls and calibrator at 15 to 30°C or at 2 to 8°C and at 15 to 30°C or at 2 to 8°C respectively only if performing a calibration run.
- Store the thawed assay controls and calibrators at 2 to 8°C for up to 24 hours before use
- Once thawed, the new amplification reagents can be stored at 2 to 8°C for up to 24 hours if not used immediately.
- Store the Abbott Real Time HIV-1 Amplification Reagent Pack and Internal Control vials must be stored at -10°C or colder when not in use.

#### **8.9.8.2 Sample storage**

- Freshly drawn samples (whole blood) may be stored at 15 to 30°C for up to six hours or at 2 to 8°C for up to 24 hours, prior to centrifugation.
- Plasma samples may be stored at 15 to 30°C for up to 24 hours or at 2 to 8°C for up to 5 days.
- If longer storage is required, plasma samples must be kept at -70°C or lower. Multiple freeze-thaw cycles should be avoided.
- If frozen, thaw plasma samples at 15 to 30°C or at 2 to 8°C. Once thawed, if plasma samples are not being processed immediately, they can be stored at 2 to 8°C for up to six hours.

#### **8.9.9 Safety**

- i. Decontaminate working surfaces twice daily, in the morning and afternoon
- ii. Adhere to safety precautions as stated in the Safety manual
- iii. All personal protective equipment (PPE) must be worn when performing this procedure.
- iv. All samples must be regarded as potentially infectious.
- v. Do not use kit beyond the expiration date which appears on the package label or device in a damaged pouch.
- vi. To reduce the risk of nucleic acid contamination, clean and disinfect spills of samples by including the use of tuberculocidal disinfectant such as 1.0% sodium hypochlorite or other suitable disinfectant.
- vii. Change gloves before handling the amplification reagents

#### **8.9.10 Calibration**

Follow the manufacture instruction to calibrate the M2000sp/rt.

#### **8.9.11 Quality Control**

- Run internal Quality Control samples to ensure quality of examination results.
- Include the Negative control, a low positive control and high positive control in each test order to evaluate run validity.
- If negative or positive controls are out of range, all the samples and controls from that run must be reprocessed, beginning with the sample preparation.

Conditions that drive controls include:

- i. After a reagent lot number change
- ii. After maintenance, component replacement, or a field service action
- iii. After a software change
- iv. Following calibration.
- v. According to regulatory requirements

### 8.9.12 Procedure Steps

- i. Load reagents depending on the number of samples be loaded as described in the table1 below

Sample preparation reagents and internal control requirement				
Reagent	1 to 24 Reactions	25 to 48 Reactions	49 to 72 Reactions	73 to 96 Reactions
mMicroparticles	1 bottle	2 bottles	2 bottles	2 bottles
mLysis	1 bottle	2 bottles	3 bottles	4 bottles
mWash 1	1 bottle	2 bottles	3 bottles	4 bottles
mWash 2	1 bottle	2 bottles	3 bottles	4 bottles
mElution Buffer	1 bottle	2 bottles	3 bottles	4 bottles
Internal Control	1 new vial or 1 partial vial	1 new vial or 2 partial vials	2 new vial or 3 partial vials	2 new vial or 4 partial vials

- ii. Gently invert the Abbott M2000 Sample Preparation bottles to ensure a homogeneous solution.
- iii. If crystals are observed in any of the reagent bottles upon opening, allow the reagents to equilibrate at room temperature until the crystals disappear.
- iv. Do not use the reagents until the crystals have dissolved.
- v. Vortex each IC 3 times for 2 to 3 seconds before use.
- vi. Use a calibrated precision pipette dedicated for internal control use only to add 500µl of IC to each bottle of m-Lysi
- vii. Mix by gently inverting the container 5 to 10 times to minimize foaming. Partial vials of IC can be recapped and stored at -25 to -15°C for a second use.
- viii. A total of 96 samples including negative control, low positive control and a high positive control samples are included in each run, can be processed in each run except for the 1.0 ml Assay Application.
- ix. A total of 48 samples including negative control, low positive control and a high positive control samples are included in each run for the 1.0 ml Assay Application
- x. Centrifuge samples at 2000g for 5 minutes before loading onto the Abbott m2000sp worktable.

Abbott Real Time HIV-1 Minimum Sample Volume Assay Application				
Tube diameter	0.2ml	0.5ml	0.6ml	1.0ml

11.5-14.0mm	0.4-0.8ml	0.7-1.2ml	0.8-1.3ml	1.2-1.7ml
14.5-16.0mm	0.4-1.0ml	0.8-1.4ml	0.9-1.5ml	1.3-1.9ml

- xi. Prior to opening the amplification, ensure that the contents are at the bottom of the vials by tapping the vials in an upright position on the bench.
- xii. Remove and discard the amplification vial caps
- xiii. A second amplification reagent pack is required if performing 25 to 48 samples
- xiv. A third amplification reagent pack is required if performing 49 to 72 samples
- xv. A fourth amplification reagent pack is required if performing 73 to 96 samples

<b>Amplification Reagent Pack Requirements (Table 3)</b>			
1 to 24 Reactions	25 to 48 Reactions	49 to 72 Reactions	73 to 96 Reactions
1 if new, up to 4 with partial packs	2 if new, up to 4 with partial packs	3 if new, up to 4 with partial packs	4 new or partial packs

### **Post Processing Procedures**

Remove the Abbott 96 Deep-Well Plate from the worktable and dispose  
Place the Abbott 96-Well Optical Reaction Plate in a sealable plastic bag and dispose along with the gloves used to handle the plate.

Clean the Abbott Splash-Free Support Base before next use, using a lint free cloth moistened with 70% alcohol.

### **8.9.13 Biological Reference Interval**

Not applicable

### **8.9.14 Interpretation and Reporting of Results**

- The concentration of viral HIV-1 RNA in a sample or control is calculated from the stored calibration curve.
- The Abbott m2000rt automatically reports the results on the Abbott M2000rt workstation.
- Assay results are reported in copies/ml and/or log (copies/ml) according to the desired design.

<b>Sample Volume</b>	<b>Result</b>	<b>Interpretation</b>	<b>Detection limits</b>
1.0ml	Not Detected	Target Not Detected	40-10,000,000 copies/ml
	Log <sub>10</sub> (1.60-7.00)	Detected	
0.6ml	Not Detected	Target Not Detected	40-10,000,000 copies/ml
	Log <sub>10</sub> (1.60-7.00)	Detected	
0.5ml	Not Detected	Target Not Detected	



	Log <sub>10</sub> (1.88-7.00)	Detected	75-10,000,000 copies/ml
0.2ml	Not Detected	Target Not Detected	150-10,000,000 copies/ml
	Log <sub>10</sub> (2.18-7.00)	Detected	

#### **8.9.15 Limitation of the Procedure and Sources of Error**

- Optimal performance of this test requires appropriate sample collection, storage, and transport to the testing site
- Human plasma samples (collected in ACD-A or EDTA tubes) may be used with this assay. The use of other anticoagulants has not been validated with this assay.
- The instruments and assay procedures reduce the risk of contamination by amplification product. However, nucleic acid contamination from the calibrators, positive controls or samples must be controlled by good Laboratory practices and careful adherence to the specific procedures.
- As with any diagnostic test, results from this assay should be interpreted in conjunction with other clinical and Laboratory findings. A sample with a result of “Not Detected” cannot be presumed to be negative for HIV-1 RNA.

#### **8.9.16 Performance Characteristics**

Refer to the method verification report of this procedure.

#### **8.9.17 Supporting document**

Sample collection manual and Safety Manual

#### **8.9.18 References**

- Abbott m200SP/rt uKit package insert
- Abbott m200SP/rt user manual (available on the instrument’s user interface)

## **8.10 INVESTIGATION OF CHRONIC MYELOID LEUKEMIA BY USING GENE XPERT MACHINE**

### **8.10.1 Purpose**

The purpose of this procedure is to provide detailed information on how to identify BCR-ABL mutated gene in human whole blood by using Cepheid GeneXpert machine. BCR-ABL is a mutation that is formed by the combination of two genes, known as BCR and ABL. The BCR-ABL mutation happens when pieces of BCR-ABL genes break off and switch places. BCR of chromosome 22 resulting in a fused BCR-ABL gene, whereby the fusion gene produces BCR-ABL a tyrosine kinase with deregulated activity that plays a key role in a development of CML. This test is used to diagnose chronic myeloid leukaemia and confirms (CML). Also it is used to monitor the patients with CML who are on tyrosine kinase inhibitor dosage.

### **8.10.2 Scope**

This procedure is applicable to the Haematology for performing laboratory request of BCR-ABL test on gene Xpert test machine.

### **8.10.3 Responsibility**

Qualified trained and competent assessed Medical Laboratory Technologists and Scientists are responsible for doing this procedure.

The head of section Haematology is responsible for ensuring the effective implementation and competency assessment for this procedure.

### **8.10.4 Principle**

The Xpert BCR-ABL Ultra is an automated test for quantifying the amount of BCR-ABL transcript as a ratio of BCR-ABL/ABL. The GeneXpert Instrument Systems automate and integrate:

Sample purification, Nucleic acid amplification, and Target sequence detection in simple or complex samples using real-time RT-PCR and nested PCR assays.

The systems consist of an instrument: - Computer, and pre-loaded software for running tests and viewing the results. The systems require the use of single-use, disposable GeneXpert cartridges that hold the RT-PCR and nested PCR reagents and host the RT-PCR and nested PCR processes.

### **8.10.5 Sample Requirements**

4ml of whole blood venous blood collected in EDTA tube. (preferably peripheral blood sample).

### **8.10.6 Equipment**

GeneXpert machine, Vortex, Timer (stop watch),

### **8.10.7 Materials**

<b>Reagent</b>	<b>Consumables</b>
BCR-ABL ultra cartridge	Micropipette and tips
Proteinase kinase (PK)	Conical tubes 50mls

Lysis reagent (LY)Guanidinium chloride Wash reagent Ethanol Guanidinium thiocyanate Ethanol-absolute	Personal protective equipment EDTA vacuum blood collection tube (4 ml )
--	--

### **8.10.8 Storage and Stability**

- When not in use, store blood samples at 2-8 °C for up to 72 hours (3 days) for EDTA samples.
- Do not open the cartridge lid until you are ready to perform the assay.
- Use the cartridge and reagents within 60 minutes after opening the lid. Except for the Lysis Reagent, do not use reagents that have become cloudy or discoloured.
- The Lysate can be stored at 72hrs at -20°C and after thawing do not re-freeze.
- Store quality control materials following blood sample storage sample storage.

### **8.10.9 Safety**

- Treat every sample as highly infectious and observe universal safety precautions.
- All personal protective equipment (PPE) must be worn when performing this procedure.
- Refer to National infection prevention and control Guidelines for health waste management and safety practice.

### **8.10.10 Calibration**

Calibration of Vortex and Timer should be done following schedule.

### **8.10.11 Quality Control**

- Endogenous control (ABL): normalizes the BCR-ABL target and ensures that sufficient sample is used in the assay.
- The Probe Check Control (PCC) verifies reagent rehydration, PCR tube filling in the cartridge, probe integrity, and dye stability.
- Control samples are obtained from EQA or in-house controls
- Perform control on daily basis before sample testing.

### **8.10.12 Procedure**

- Before sample is processed on Xpert BCR - ABL machine, Run FBP on patient sample in order to know the Total white blood cell count, WBC  
If WBC count is < 30K/μL, use 4ml of patient whole blood
- If WBC count is (30-50 K/μL) of whole blood, use 50ul of whole blood.
- If WBC count range (51-100K/ μL) Use 20ul of whole blood.
- If WBC count range (100 -1000K/μL) and above, put 10ul of whole blood
- Technical Procedures on Xpert BCR – ABL Ultra

- vi. Mix well your sample in EDTA tube.
- vii. Put micro litres of patient sample according to Total WBC count obtained in FBP machine, see above pre-analysis procedures.
- viii. Add 100ul of PK, vortex for 5sec and incubate for 1min.
- ix. Add 2.5ml of Lysis Vortex for 10seconds and incubate for 5min X2
- x. Mix and Transfer 1ml of Lysate to new tube.
- xi. Add 1.5ml of Lysis reagent and vortex for 10seconds then incubate for 10mins.
- xii. Lastly add 2ml of Ethanol vortex for 10seconds
- xiii. Add wash buffer in the small hole on left side of the cartridge and patient's prepared sample(4.5mls) in large hole on right side of the cartridge
- xiv. Take cartridge to machine, start analysis. open your computer GeneXpert program by double clicking and create Test

#### **8.10.13 Biological Reference interval**

Not applicable

#### **8.10.14 Results interpretation**

The results are interpreted automatically by the machine from measured fluorescent signals and embedded calculation algorithms which interpret the following;

BCR-ABL DETECTED,  
BCR-ABL NOT DETECTED OR  
INVALID (repeat test).

#### **8.10.15 Limitations of the procedure and sources of error**

Avoid use of hemolysed or clotted samples and follow all limitations as directed by manufacture.

#### **8.10.16 Performance Characteristics**

Refer to Method verification report.

#### **8.10.17 Supporting Documents**

Sample collection manual, safety manual, and quality manual and result management procedure.

#### **8.10.18 References**

Baccarani M, et al. (2006). Evolving concepts in the management of chronic myeloid leukemia: recommendations from an expert panel on behalf of the European LeukemiaNet. Blood 108:1809.

Dacie & Lewis Practical Haematology.

# CHAPTER 9: ANATOMICAL PATHOLOGY

## 9.1 PROCEDURE FOR PERFORMING SEMINALYSIS

### 9.1.1 Purpose

This procedure provides instructions for performing semen analysis for determining male fertility.

### 9.1.2 Scope

This procedure is to be used in Hospital laboratory for semen analysis

### 9.1.3 Responsibility

Qualified and trained Medical Laboratory Technicians, Technologists and scientists are responsible for implementing this test procedure.

The Head of Unit is responsible for ensuring the effective implementation of this procedure.

### 9.1.4 Principle

Investigating male fertility status as well as monitoring spermatogenesis during and following male fertility regulation.

### 9.1.5 Sample requirements

Semen sample collected in leak proof, plastic or glass container.  
Collect sample following four days of sexual abstinence.

### 9.1.6 Equipment

Improved Neubauer counting chamber, Microscope

### 9.1.7 Materials

Reagent	Consumables
<ul style="list-style-type: none"><li>• Isotonic sterile saline,</li><li>• Crystal violet,</li><li>• 70% Ethanol,</li><li>• Formalin 4%,</li><li>• Sodium bicarbonate,</li><li>• distilled water,</li><li>• Aniline Blue,</li><li>• Distilled Water or phosphate buffer,</li><li>• Sodium Chloride,</li><li>• Eosin Y, Resorcinol</li><li>• 1N Hydrochloric acid,</li></ul>	<ul style="list-style-type: none"><li>• Freshly produced semen</li><li>• Retrograde Ejaculate Concentrate</li><li>• Cryo-semen in tube</li><li>• Surgically obtained</li></ul>

### Reagent preparation

#### a) Semen Diluent 1

Isotonic sterile saline	240 ml
-------------------------	--------

Crystal violet	1.0 g
70% Ethanol	50.0 ml

Note: Store in the refrigerator

**b) Semen Diluent 2**

Formalin 4%	1 ml
Sodium bicarbonate	5.0 g
Distilled water	100.0 ml

**c) 0.1% Aniline blue solution**

Aniline Blue	0.1g
Distilled Water or phosphate buffer	100 mls

**Note:** The concentration of Aniline Blue solution can be adjusted to suit the specific needs of the analysis, but a concentration of 0.1% is commonly used for sperm viability testing. It is important to prepare fresh Aniline Blue solution for each analysis and to avoid exposure to light, as this can degrade the stain.

**d) 0.5% Eosin solution**

Sodium Chloride	0.9 g
Distilled water	100ml
Eosin Y	0.5 g

Dissolve Sodium chloride to distilled water then add Eosin Y.

**e) Resorcinol-hydrochloric acid (RHA)**

Resorcinol	1 g
1N Hydrochloric acid	1 ml
Distilled water	1 ml

**9.1.8 Storage and stability**

The semen should be kept between 20 °C to 37 °C and should be examined within 1 hour after collection

**9.1.9 Safety**

- Semen samples may contain dangerous infectious agents (e.g. human immunodeficiency virus (HIV), hepatitis viruses or herpes simplex virus) and should therefore be handled as a biohazard.
- Always wear gloves, mask and goggles when handling Xylene.
- Ethanol is flammable. Store properly in flammable cabinet. Use gloves and gown when working with ethanol solutions.
- Wear solvent-resistant gloves (e.g., nitrile) and a fluid-impervious laboratory coat at all times when working with stains. Wear goggles when cleaning and changing solutions.

**9.1.10 Calibration**

All auxiliary equipment should be calibrated annually

**9.1.11 Quality control**

Known azoospermic fixed slide and known smear with sperms can be used as control. Control materials can be obtained in house. Also control materials obtained commercially might be useful to verify quality of the procedure.

•  
**9.1.12 Procedure Steps**

<b>Macroscopic Examination</b>		
STEP	PARAMETERS	ACTION
A)	Appearance	Report the appearance of the semen within an hour of collection. E.g.:
B)	Liquefaction	<ul style="list-style-type: none"> <li>a. Leave it at room temperature or incubate the sample for 20 - 30 minutes after collection.</li> <li>b. Check a well-mixed sample for completion of liquefaction, if not wait for an additional few minutes.</li> <li>c. For further testing, semen must be fully liquefied by either mechanical mixing or catalisation by an enzyme. Needling must not be used.</li> </ul>
C)	Volume	Determine the sample volume. <ul style="list-style-type: none"> <li>a. A graduated 5 or 10 ml pipette or plastic disposable, graduated pipettes may be used.</li> <li>b. Volume should not be determined using a syringe and needle as the rubber plunger and needle have an effect on sperm motility. Rubber less syringes can be used</li> </ul>
D)	Viscosity	Using a Pasteur pipette draw a portion of the sample and then allow a drop to fall back in the sample container, watch how the drop “strings” down before breaking. <ul style="list-style-type: none"> <li>a. Normal – When a drop strings to a length of 0.5 to 1cm</li> <li>b. Increased – When a drop strings out more than 2 cm</li> <li>c. Reduced – When a drop breaks out without stringing down</li> </ul>

**Microscopy**

**a) Sperm Motility**

Quantitative Motility is determined by estimating visually the percentage of motile spermatozoa and non-motile spermatozoa.

Qualitative Motility is determined subjectively by grading the forward progression made by the largest number of spermatozoa, as none, poor, good and excellent.

Normal Motility is shown by 60% or greater motile spermatozoa with the majority exhibiting good to excellent forward progression at one half hour to 3 hours after ejaculation.

*Motility Assessment in Sufficient Sperm cells*

<b>Step</b>	<b>Action</b>
A)	Deliver 10µl of well-mixed semen onto glass slide and cover with a 22x22mm coverslip. Approx. 20µl for 22x50mm coverslip or 24µl for 24x50mm coverslip
B)	Allow to settle for approximately 1 minute.
C)	Microscopically examine the semen with a 20x or 40x magnification lens with a reticle eyepiece.
D)	Examine and score 10 random moving sperms in a single field by analysing their movements. then
E)	Examine at least 10 fields (100sperms) at the centre of the cover slipped area and assess the average percentage of motile spermatozoa seen.

*Motility Assessment in Insufficient sperm cells*

<b>Step</b>	<b>Action</b>
<b>1</b>	Dilute the semen in the conical tube with HTF culture media and mix well
<b>2</b>	Centrifuge the mixture at 2000rpm for 10 minutes
<b>3</b>	Using a Pasteur pipette, remove the supernatant and pipette the a drop of sediment onto a slide then warm for approx. 5 minutes
<b>4</b>	Microscopically examine the semen with a 20x or 40x magnification lens with a reticle eyepiece.
<b>5</b>	Examine and score 10 random moving sperms in a single field by analysing their movements. then
<b>6</b>	Examine at least 10 fields (100sperms) at the centre of the cover slipped area and assess the average percentage of motile spermatozoa seen.

Assess only intact spermatozoa (defined as having a head and a tail; since only intact spermatozoa are counted for sperm concentration.

Do not count motile pinheads.

***Vitality staining***

Sperm vitality, as estimated by assessing the membrane integrity of the cells, maybe determined routinely on all samples, but is especially important for samples with less than about 30% progressively motile spermatozoa. This test can provide a check on the motility evaluation, since the percentage of dead cells should not exceed (within sampling error) the percentage of immotile spermatozoa. The percentage of viable cells normally exceeds that of motile cells.

Supravital staining: The staining of live spermatozoa (vital) outside (supra) the human body.



- i. Take a glass slide and Add 1 drop of 0.1% Aniline Blue stain or 0.5% Eosin to 1 drop of semen ( $\pm 50\mu\text{l}$ ).
- ii. Mix gently.
- iii. Make duplicate thin smears of above mixture on the glass
- iv. slides.
- v. Allow the slides to air dry.
- vi. Using the 40x or 100 x oil immersion lenses, screen at least 100 spermatozoa.
- vii. Spermatozoa that appear white (unstained) are recorded as alive (Vital), and those showing blue cytoplasmic coloration (stained) are recorded as dead (Non-Vital). In case Eosin is used the colour will be pink
- viii. For quality control reasons, count 100 spermatozoa per slide, and the difference of the counts on both slide must not differ by more than 10%. This is determined by verifying that the difference between the two counts of vital spermatozoa is less than 1/20 of their sums.
- ix. If the difference is greater than 10%, a third count must be carried out and the average of the three must be calculated and reported as a percentage of vital spermatozoa.
- x. When counting various fields on the slide keep away from the edges.
- xi. Sperm vitality should be assessed as soon as possible after liquefaction of the semen sample, preferably at 30 minutes, but in any case within 1 hour of ejaculation, to prevent observation of deleterious effects of dehydration or of changes in temperature on vitality.

### ***Sperm Concentration using a Neubauer Counting Chamber***

<b><i>Step</i></b>	<b><i>Parameter</i></b>	<b><i>Action</i></b>
<b>1</b>	Dilution	<ul style="list-style-type: none"> <li>• Use a micropipette to dispense the appropriate amount of fixative/diluent into two dilution vials.</li> <li>• Mix the semen sample well</li> <li>• Aspirate the appropriate volume of semen immediately after mixing, allowing no time for the spermatozoa to settle out of suspension</li> <li>• Wipe the semen off the outside of the pipette tip, taking care not to touch the opening of the tip.</li> <li>• Dispense the semen into the fixative and rinse the pipette tip by aspirating and expressing the fixative.</li> <li>• Mix the semen sample well again, and prepare the replicate dilution following the steps above.</li> <li>• Mix the first dilution thoroughly by for 10 seconds. Immediately remove approximately 10 <math>\mu\text{l}</math> of fixed/diluted suspension, to avoid settling of the spermatozoa.</li> </ul>
<b>2</b>	Neubauer Chamber set up and loading	<ul style="list-style-type: none"> <li>• Touch the pipette tip carefully against the lower edge of one of the chambers at the V-shaped groove.</li> <li>• Depress the plunger of the pipette slowly, allowing the chamber to fill by capillary action. The coverslip should not be moved during filling, and the chamber should not be overfilled (when the coverslip may be seen to move) or under filled (when air occupies some of the chamber area).</li> </ul>

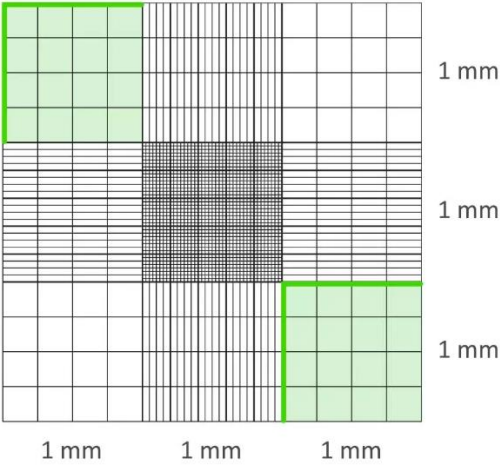
		<ul style="list-style-type: none"> <li>• Mix the second dilution, as above, and immediately remove a second 10- l aliquot. Load the second chamber of the haemocytometer following the steps above.</li> <li>• Store the haemocytometer horizontally for at least 4 minutes at room temperature in a humid chamber (e.g. on water-saturated filter paper in a covered Petri dish) to prevent drying out. The immobilized cells will sediment onto the grid during this time.</li> </ul>
<b>3</b>	Counting	 <p>a. First assess the 2 corner grids of one side of the improved Neubauer chamber, row by row.</p> <p>b. Count sperms in all small 16 squares of the upper left square</p> <p>c. Free/loose heads and pinheads are not counted. Do not count sperm whose heads touch the upper or left side of the block being counted.</p> <p>d. Continue counting the other diagonal square which is the right bottom.</p>
<b>4</b>	Calculations	<p>a. Calculate the sum of the two numbers obtained from both 2 squares.</p> <p>b. Then calculate using the formula: - <math>n = (N \times 10 \times 20 \times 1000) / 2</math>, see the explanation below</p> <p>c. The results should be reported as number of sperms in Millions per ml e.g. 30mil/ml</p>

Note: Total number of sperm per mL (n) = (Number of sperm counted in two corner squares x 10 x 20 x 1000) / 2

Where:

- N=Number of sperm counted in two corner squares = the number of sperm counted in the two corner squares of the Improved Neubauer Chamber
- 10 = the conversion factor from squares to millions of sperm
- 20 = the dilution factor of 1:20
- 1000 = the conversion factor from millilitres to microliters

- 2 = the number of corner squares counted

Table 1. Determining the required dilution for Neubauer Chamber

Spermatozoa /x40 field	Spermatozoa /x20	Dilution required	Semen (µl)	Diluent (µl)	Chamber	Area to be assessed
>101	>404	1:20 (1+19)	50	950	Improved Neubauer chamber	Diagonal Corner grids
16-100	64-400	1:5 (1+4)	50	200	Improved Neubauer chamber	Diagonal Corner grids
2-15	8-60	1:2 (1+1)	50	50	Improved Neubauer chamber	Diagonal Corner grids
<2	<8	1:2	50	50	Improved Neubauer chamber	All Grids or Entire Slide

### **Sperm Morphology**

Step	Parameter	Action
A)	Making Smears & Staining	<ol style="list-style-type: none"> <li>Place 1 drop of semen in centre of a clean slide.</li> <li>Place a second slide on top of the first slide and allow the semen to spread between them.</li> <li>Gently pull the two slides apart using a sliding action thus making 2 slides simultaneously.</li> <li>Allow the slides to air dry.</li> <li>Fix the smears with 95% ethanol or 50/50 ether/ethanol.</li> <li>Stain the slides using the <b>Papanicolaou's</b> staining procedure.</li> <li>Mount the slides with DPX</li> </ol>
B)	Counting of Spermatozoa	<ol style="list-style-type: none"> <li>Count at least 100 spermatozoa (preferably 200) on each slide at x100 oil magnification.</li> <li>Each sperm is counted according to the scoring system being used.</li> <li>If the morphology count differs by more than 10%, recount both slides.</li> <li>Calculate the mean of the counts.</li> <li>Report in percentages of both Normal and Abnormal morphologies.</li> </ol>

## Biochemistry

### a). Semen Fructose

This is an indicator of the secretory function of the seminal vesicles and is important in cases of **azoospermia**, where negative semen fructose levels may indicate congenital bilateral absence of the seminal vesicles and vas deferens.

Step	Action
A)	Take a semen sample and dilute it in saline or buffer solution, if necessary.
B)	Mix the semen sample with RHA solution in a proportion of 1:1, usually 2-3 drops of semen and 2-3 drops of RHA solution.
C)	Incubate the mixture for 5-10 minutes at 37°C.
D)	Observe the mixture for any colour change, typically from yellow to blue or green, indicating the presence of fructose.
E)	The test is considered positive if the colour changes from yellow to blue or green, indicating the presence of fructose in the semen. If there is no colour change, the test is considered negative.

**Note:** It's important to note that a positive result in the semen fructose test indicates the presence of functional sperm, but it is not a definitive test for male fertility. Other factors such as sperm count, motility, and morphology also contribute to male fertility.

### b). Measure the pH

- i. Using a narrow range pH paper, e.g. pH 6.4–8.0, spread a drop of liquefied semen on the paper.
- ii. After 30 seconds, record the pH.
- iii. pH of normal semen: Should be pH 7.2 or more within 1 hour of ejaculation.
- iv. When the pH is over 7.8 this may be due to infection.
- v. When the pH is below 7.0 and the semen is found to contain no sperm, this may indicate dysgenesis (failure to develop) of the vas deferens, seminal vesicles or epididymis

### 9.1.13 Biological Reference Intervals

- a) Appearance homogenous grey
- b) Volume 2-5mls
- c) Motility –forward progressive movement over 50% of spermatozoa are motile within 1hrs of ejaculation
- d) Viscosity about 1.5cm to 2cm
- e) PH 7.2-7.7 within one hour of ejaculation
- f) Sperm count 20-150 million per ml
- g) Fructose level

### 9.1.14 Interpretation and Reporting of Results

Sample which met the criteria of reference range above is normal

Appearance: colour

Volume: mls

Motility: forward progressive movement, sluggish movement or Immotile

Viscosity: cm

pH

Sperm count million per ml

Oligospermia = Decreased number of spermatozoa in the semen

Azoospermia = Lack of live spermatozoa in the semen

Necrospermia = Condition in which the spermatozoa of the semen are dead or Motionless

#### **9.1.15 Limitations of the Procedure and Sources of Error**

Delaying sample from time collected to laboratory affect results

Coitus interrupts method of collection may affect concentration of spermatozoa because first portion of ejaculation may be lost, also acidic pH of vaginal affect sperm motility and semen may be contaminated with cells and bacteria

If the temperature is not adhered during transportation, affects the results

#### **9.1.16 Performance Characteristics**

Not applicable

#### **9.1.17 Supporting documents**

Laboratory quality policy manual

Laboratory safety policy manual

Laboratory sample collection manual

#### **9.1.18 References**

Bancroft JD, Stevens, Alan. *Theory and Practice of Histological Techniques 6th ed.* Churchill Livingstone; 2008.

WHO laboratory manual for the Examination and processing of human semen,5th edition. 2010

Medical laboratory manual for tropical countries by Monica Cheesbrough 2nd edition 2010

## **9.2 PROCEDURE FOR MORTUARY SERVICES**

### **9.2.1 Purpose**

This procedure provides instructions for providing mortuary services including autopsy practice, embalming as well as safety of personnel, visitors and community.

### **9.2.2 Scope**

This document provides guidelines for the mortuary staff and administration recommended standards for mortuary facilities in settings and for communication between staff involved in autopsy procedures or autopsy related processes.

Body storage

A body cold store having a capacity appropriate for the mortuary workload should be maintained at a temperature of about 2- 6 ° C.

If long term storage is required, the body should have maintained at approximately - 20 ° C.

Labelling procedures should be established so that body identification is made easy.

### **9.2.3 Responsibility**

Qualified and trained mortuary personnel are responsible for implementing this procedure.

The Head of Laboratory is responsible for ensuring the effective implementation and maintenance of this procedure.

### **9.2.4 Principle**

Not applicable

### **9.2.5 Sample requirements**

Not applicable

### **9.2.6 Equipment**

Refrigerator, Trolley, Post-mortem kit

### **9.2.7 Materials**

10% formalin, Gloves, Leak proof bag, gloves, water resistant gown/plastic apron over water repellent gown, and surgical masks, goggles or face shield, shoe covers

### **9.2.8 Storage and stability**

Dead body: For short term store at 2-6°C, For long term store -20°C

10% formalin: Store at room temperature

### **9.2.9 Safety**

- PPE shall be used to prevent skin and mucous membrane contact with blood and other body fluid. These may include the use of gloves, N95 masks, protective eye wear, face shields, shoe covers, plastic aprons/gowns hair bornets, cut resistant gloves and laboratory coats.

Surgical or post mortem gloves must be worn by all personnel involved in the autopsy procedure

#### **Hand washing:**

- Hand and other skin surface should be washed with soaps and water immediately after contact with blood or other body fluid. Hand shall be washed each time with running water and soap.
- Sufficient and appropriate disinfectant should be 0.5% chlorine solution for routine mortuary work, embalming and post-mortem, then removed and rinsed with distilled water before being dried and stored.
- Appropriate vaccination and follow up of immunity status should be offered to all mortuary staff and record should be maintained including any refusal of an offer of immunization.
- The Mortuary personnel is responsible to ensuring that he/she complies with policies guarding personal safety, handling of bodies and bodily fluids as well as the safe operation of Mortuary equipment.
- Put bio hazardous waste in a red biohazard bag
- Put the red bag in the bio hazardous waste box
- Tape box closed
- Put taped box in bio hazardous waste pick up location
- The Medical Attendants must wear complete PPE when handling hazardous waste.

#### **Autopsy Instruments:**

- All instruments are to be cleaned and disinfected between examinations, instruments should be dried and laid out on a non-metal surface
- Autopsy Tables and Garbage Disposals: Autopsy tables should be cleaned and disinfected between autopsies or at the end of the day
- Following the autopsy, the disposals and drain on each autopsy table should be cleaned.

### **9.2.10 Calibration**

Calibration for refrigerators should be done as per schedule

### **9.2.11 Quality control**

Not applicable

### **9.2.12 Procedure for receiving died body from inside the facility.**

After receiving a call from the ward there is a dead body the following procedure should be followed.

- Prepare the trolley by making sure it is well covered.
- Make sure you have put on proper personal protective equipment such as apron, face mask, boot and gloves.

### **9.2.13 In the ward you should observe the following before:**

If the dead body is well labelled

> If the mortuary forms have been filled in and signed by the nurse

> Make sure you sign the death book before you take the body

### **9.2.14 Once you reach in the mortuary do the documentation first**

- inform the relatives about the process that they should follow including how to do the payments and how to get the discharge summary.
- Dead body should be kept in a cooling unit (with tags as above)
- Make sure to label on the form the number of the fridge (unit) and the fridge should have a tag number which should match with that attached to the body inside.

Note: Tags have to be attached to the big toes /or around the circumference of the ankle

### **Receiving dead body from outside the facility brought by police, relatives or good Samaritans.**

After receiving a dead body from the police or relatives from home the following procedures should be followed

- i. First get the information, document the police/transport ID/telephone number
- ii. Prepare the trolley to receive the dead body
- iii. Check the body appearance and attached properties, if it's a police case after documentations put the dead body directly to the cooling unit and wait for post-mortem exam to be done.
- iv. Provide the mortuary identity card to the police, if will be later on provided to the relative
- v. If it's a home cases after documentation inform the relatives about the other process of payments.
- vi. After payments request the nearby relative to attend the embalming procedure then keep the dead body in the cooling unit after following the identification procedure and make sure it is well labelled.
- vii. Make sure you label the form to indicate which unit the dead body has been put in.



### **9.2.15 Releasing the died body from mortuary to relatives**

Before giving out dead bodies following procedure should be followed;

- i. For the dead body from the facility make sure the relative comes with the discharge summary, burial certificate and the proper receipt.
- ii. Check if the information has been filled well in the mortuary register book.
- iii. When relative have accomplished all the process and have all the form needed, assist them to prepare the dead body and keep it in a good condition
- iv. Allow them to leave after finishing all the process.
- v. For out - patients make sure the relatives come with the burial certificate/or letter from local government if they have it and proper receipts.
- vi. When they have accomplished all process, assist them to prepare the body in the washer rooms and make sure equipment, water and sanitation is well controlled.

### **9.2.16 Handling personal property and clothing**

Personal property that arrives with decedent remains shall be processed as follows;

- i. Decedent's personal property will be entered into register book upon admission.
- ii. Clothing should be described by colours and items
- iii. Personal effect such as jewellery, watch as well as money should only be removed in the presence of relatives/police.
- iv. Personal effects such as jewellery should be described in non-valuable terms e.g. yellow metal or coloured stone.

### **9.2.17 Embalming procedure**

It consists of arterial infusion of embalming fluid (10% Formalin). Since most bodies are not disposed within 72hrs after death, hence the importance of a mortuary establishing this service.

- i. Arrange all your equipment that are needed for embalming.
- ii. Prepare the formalin solution 10% concentration
- iii. Put on the proper protective equipment
- iv. Prepare the body to be embalmed
- v. Start the embalming procedure
- vi. Make sure that body has a label and tag
- vii. Clean the area and the equipment that have been used.

### **9.2.18 Autopsy procedure**

- i. Autopsy has to be complete routinely.
- ii. A complete autopsy is defined to include a detailed external examination as entire body and an internal examination to include the removal and dissection of all thoraco –abdominal and neck organs, opening the head with the removal and examination of the brain
- iii. A complete autopsy does not require histological examination

- iv. A patient autopsy is defined as an examination that surface any part of the defined complete autopsy e.g. not opening any of the body cavities or not examining organs.
- v. An external examination is defined as a detailed description of the decedents remains including scars, surgical incisions, medical devices and tattoos.

### **9.2.19 Pre-autopsy procedures**

Prior to autopsy the medical attendant will set up the autopsy work room according to the case examination status including preparing tables for body dissection, preparing instruments, preparing sample containers and collection tubes, preparing paper work for daily case load and taking radiographs.

Autopsy work room should be set up with the following instruments supplies, in certain cases it will be necessary to equip the autopsy work room with specialized instruments or additional supplies.

### **9.2.20 The standard autopsy precautions including using:**

- A surgical scrub or suits
- Surgical cap
- Impervious gown or apron with full sleeves coverage
- A form of eye protection e.g. goggles or face shield
- Shoe covers
- Double surgical gloves with interposed layer of cut proof synthetic mesh.
- Surgical masks that may protect nose and mouth from splashes of body fluids but do not always offer protection from airborne pathogens
- Use of respiration in adequate resources
- Safety practices to prevent injury from sharp items including hand washing as necessary after glove removal

### **9.2.21 Peri autopsy procedure**

- i. Remove bodies from body storage colder in the stage in autopsy suits
- ii. Identification by the relatives and authorised photographer can take photos
- iii. Undress and transfer remaining to autopsy table
- iv. Remove medical intervention devices and wash remains
- v. Assist photographer in taking autopsy photographs and ID photos
- vi. Perform initial Y or median incision
- vii. Remove chest plate
- viii. Open thoracic and abdominal cavities
- ix. Medical attendant has to assist the pathologist in obtaining toxicology samples (blood, bile, urine, vitreous, gastric, liver, brain)
- x. Remove organs
- xi. Weigh and record organs weight
- xii. Open the entire length of the gastro intestinal tract
- xiii. Elevate head
- xiv. Incise and reflect scalp
- xv. Remove brain
- xvi. Remove duct

- xvii. Obtain decedents fingerprints
- xviii. Perform other autopsy procedures as directed (removing spinal cord, opening inner extremities to exam pulmonary thrombo –emboli, stripping pavietal pleural, incising the psoas muscles, assisting with preparation of sex kits and DNA cards. Measure the length of a died.

### **9.2.22 Post autopsy procedures**

- i. Put organs in viscera bag
- ii. Replace body organs
- iii. Close the thoracic, abdominal and cranial cavities with sutures
- iv. Clean the body and replace in body bag
- v. Indicate completion of examination by inciting a ONE on body bag
- vi. Return body to refrigerated storage
- vii. Put sample in designated area depending on processing instructions;
  - Toxicology samples are put in toxicology refrigerator in the yellow tray labelled "toxicology"
  - Histology sections are put in the yellow tray on top of toxicology refrigerator labelled "histology"
  - Microbiology sample are put in the yellow tray on top of toxicology refrigerator labelled "micro"
- viii. Thoroughly clean and disinfect autopsy and dissection tables, sinks, drains, instruments, dry erase boards floor area
- ix. Between examinations all instruments surfaces should be cleaned with a 10% bleach solution.

### **9.2.23 Body storage and organization**

- i. Body should be stored in clean, closed body bags with no leakage of fluids on rack or tray
- ii. Place body in empty compartment head toward the wall
- iii. Tag body storage compartment with decedent name and case number
- iv. Log body on body part(s) into box and cart inventory sheet
- v. Maintain an accurate box or cart inventory sheet. The inventory sheet should be updated appropriate daily
- vi. Empty trays to the cleaned and disinfected and kept in box
- vii. All trays should be cleaned and disinfected following a release or transfer

### **9.2.24 Receiving and releasing remains**

#### **Receiving Remains;**

- i. Identify ID bracelet with Police to tag
- ii. Obtain appropriate signatures on transport notification form
- iii. Take photography using the camera
- iv. Obtain decedent height and weight
- v. Record personal property (clothing)
- vi. Complete intake of body into the logbook

- vii. Complete intake of body in FACTS
- viii. Log body on box and cart sheet
- ix. Place body in refrigerated storage

***Releasing Remains:***

- i. Confirm in FACTS that the body is ready to be released and that the receipt of remain seen has been properly completed by communications unit.
- ii. Print and sign copy of the Receipt of remains form.
- iii. Sign body out of release logbook
- iv. Obtain funeral home representatives signatures, number and initials where appropriate
- v. Have to tag and receipt of remains form witnesses
- vi. Clean and disinfect tray before retaining it to cold box

***9.2.25 Sample Storage and Retrieval***

All stock samples retained in clean and dry bottle in 10% buffered formalin label write the Post Mortem Examination Number, name, age, sex, address and anatomical site

***9.2.26 Transportation of remains***

If a body is to be shipped out of the country, a letter stating that the autopsy showed no evidence of any infections or communicable diseases is required.

In the contents of such a letter must include Identification details such as name and date of death that match the details in the transit/burial permit or death certificate.

***9.2.27 Supporting documents***

National guideline for operating of Mortuary services 2020, National guideline for establishment of Mortuary services 2020, IPC Guideline 2018

***9.2.28 References***

1. Standard guidelines for the facilities and operation of mortuaries in Tanzania 2008
2. Hutchins GM. Practice guidelines for autopsy performance. Archives of pathology and laboratory medicine, 1994, 118(1):19-25
3. Advices ED, Sims KL. Enhancing autopsy performance and reporting. A system for a 5-day completion time. Archives of pathology and laboratory medicine, 1996, 120(3):249-53.

## **9.3 PROCEDURE FOR TISSUE GROSSING**

### **9.3.1 Purpose**

This procedure gives detailed information for performing procedure for grossing of tissue biopsy sample.

### **9.3.2 Scope**

This Procedure used in the Histopathology unit for Grossing of the tissue.

### **9.3.3 Responsibility**

The head of pathology, Histotechnologists and Pathologists department is responsible for ensuring this procedure is effectively implemented and maintained.

### **9.3.4 Principle**

In Pathology, taking in/ Grossing involve macroscopic description and selection of part of the sample which is most likely to contain the disease condition. This is done by pathologist with the close assistance from Laboratory scientist.

### **9.3.5 Sample requirement**

Tissue biopsy fixed

### **9.3.6 Equipment**

Fume hood.

### **9.3.7 Materials**

Forceps, cutting board (template), Tissue cassettes, Lead pencil/permanent marker, pen, Gloves, Surgical knives, Hacking saw, Plastic apron, Laboratory coat, Plastic sleeves, Filter paper, Container with fixative, Ruler Scissors, Cassette clips, Fume mask/fume chamber, Goggles, Weighing scale, Biohazard bags (small and medium)

Reagents

37 %– 40% formaldehyde, Distilled water, 5% Nitric acid/ 10% formic acid,

### **9.3.8 Storage and stability**

Tissue is kept in Histological container with fixative.

### **9.3.9 Safety**

Observe recommended universal safety precautions: Treat all samples as infectious and decontaminate all reusable instruments before sterilization.

Dispose all used disposable materials according to safety and waste disposal management manual.

Formalin is hazardous. Always wear gloves, mask and goggles when handling it.

#### **9.3.10 Calibration**

Not applicable

#### **9.3.11 Quality Control**

Not applicable

#### **9.3.12 Procedure Steps**

- i. Use lead pencil to label cassettes with patient identification number (PID) for each sample. Select and arrange the sample in the fume chamber.
- ii. Maintain proper identification and orientation of the sample when taking in.
- iii. Use forceps to remove sample from the plastic container and place it on a template. Immediately close the container.
- iv. For poorly fixed sample (tissue) slice it, cassette it, place it in a labelled container of fresh fixative (formalin) and allow fixing for at least 24 hours.
- v. For properly fixed sample, slice it and cassette it and place in formalin prior to processing.
- vi. For bone sample, which need decalcification, identify them and decalcify before starting tissue processing.
- vii. Neatly wipe clean the template and your gloves before taking in another sample to avoid sample cross-contamination.
- viii. Remove the properly fixed tissue cassettes from the fresh formalin container and arrange them serially in the processing basket.
- ix. Put the basket with cassette containing tissues to the machine for processing.

#### **9.3.13 Biological Reference Intervals**

Not applicable

#### **9.3.14 Interpretation of results**

Not applicable

#### **9.3.15 Limitation of the procedure and source of error**

- i. Improperly labelled/unlabelled sample.
- ii. Autolyzed sample.
- iii. Sample collected in wrong container/without formalin fixative.
- iv. Wrong sample

#### **9.3.16 Performance Characteristics**

Not applicable

### **9.3.17 Supportive Documents**

Quality manual, sample collection manual, equipment management procedure

### **9.3.18 References**

- i. Bancroft JD, Gamble M. Theory and Practice of Histological Techniques. 5th ed. Churchill Livingstone; 2001.
- ii. Clayden (fifth edition) Practical section cutting and staining.
- iii. Carleton (5th edition) Histological techniques
- iv. MOH (1994) -Laboratory manual for histopathology, V.Y Mgaya, C. Lembeli, et al
- v. A manual of Histological staining methods of the Armed Forces Institute of Pathology: Lee G. Luna; 3rd edition.

## **9.4 PROCEDURE FOR TISSUE SECTION CUTTING USING ROTARY MICROTOME**

### **9.4.1 Purpose**

This procedure provides instructions for tissue section cutting using rotary microtome

### **9.4.2 Scope**

This procedure is applicable during section cutting at Hospital Laboratory.

### **9.4.3 Responsibility**

The head of Unit Histopathology is responsible for ensuring the effective implementation and maintenance of this procedure.

### **9.4.4 Principle**

The microtome knife is fixed on the microtome and the cutting edge positioned upward where the tissue moves up and down and the small size of slace will be cut according to the setup in microns.

### **9.4.5 Sample Requirement**

Tissue on tissue block or Cell on cell block.

### **9.4.6 Equipment**

Rotary Microtome, water bath, **Hot block**

### **9.4.7 Materials**

#### **9.4.7.1 Reagents**

No reagent used

#### **9.4.7.2 Consumables**

Frosted slides, microtome blades, Pencil, Ice packs, Thermometer, Brush.

### **9.4.8 Storage and stability**

Store block in 2 °c-8 °c before being sectioned and room temperature after sectioning.

### **9.4.9 Safety**

Handle sharp instrument carefully.

Dispose all used disposable material according to safety and waste disposal management manual.

### **9.4.10 Calibration**



Calibration of water bath and hot follows calibration schedule.

#### **9.4.11 Quality control**

Not applicable

#### **9.4.12 Procedure Steps**

- i. Set the Microtome to trim at 15-20  $\mu\text{m}$
- ii. Cover the blade and fix tissue block in the Microtome's block holder.
- iii. Adjust the feed mechanism until the wax block touches the knife by moving the block holder forward and upward
- iv. Ensure that the whole surface of the block will move parallel to the edge of the trimming blade in order to ensure a straight ribbon of section.
- v. Tighten all adjusting screws on the Microtome as faults on sectioning are most frequently due to looseness of the block or knife.
- vi. Trim the block at 15-20 $\mu$  until full surface of the tissue is exposed.
- vii. Remove the trimmed tissue block from the Microtome and place it on freezer to cool.
- viii. Replace the fixed microtome blade with the new one and check that it is screwed tightly in the position.
- ix. Set the Microtome's thickness gauge to 3  $\mu\text{m}$  for section cutting.
- x. Wipe the surface of the cooled tissue block free of water and place it into the block holder.
- xi. Operate the Microtome until complete sections have been cut.
- xii. Float the cut section onto the water bath (at 45°C).
- xiii. Label another clean frosted glass slide with same BH number as on the block and use it to pick the floating cut section.
- xiv. Stand the slide on a grooved wooden rack and leave for 10- 15 minutes to dry.
- xv. Place the dried slide with cut section onto hot plate (600C) to melt the wax for 15 minutes.
- xvi. Arrange in a staining rack and send for staining procedure immediately after removing from the hot place.

#### **9.4.13 Biological reference interval**

Not applicable

#### **9.4.14 Interpretation and reporting results**

Not applicable

#### **9.4.15 Limitations of the procedure and sources of error**

Poor fixation

Calisified tissue hinder the tissue processing

Exposing tissue at high temperature.

#### **9.4.16 Performance Characteristics**

Refer method verification report

#### **9.4.17 Supporting Documents**

Results Management Procedure, Safety Manual, Sample Collection Manual, Sample Management Procedure.

#### **9.4.18 References**

- Thermo Scientific HistoStar operator guide A81010100 issue7
- Bancroft JD, Gamble M. Theory and Practice of Histological Techniques.

## **9.5 PROCEDURE FOR PERFORMING TISSUE EMBEDDING**

### **9.5.1 Purpose**

To provide instructions for paraffin tissue embedding

### **9.5.2 Scope**

This procedure is applicable during paraffin tissue embedding at hospital laboratory

### **9.5.3 Responsibility**

The head of Histopathology is responsible for ensuring effective implementation and maintenance of this procedure. Qualified and trained health laboratory practitioners are responsible for doing this test procedure.

### **9.5.4 Principle**

The paraffin wax used to hold the tissue during making tissue block. The wax does not penetrate in the tissue.

### **9.5.5 Sample Requirement.**

Processed sample cassette.

### **9.5.6 Equipment.**

Embedding system.

### **9.5.7 Materials.**

Paraffin Wax, Moulds, Cassettes, Permanent marker pen / Pencil, Forceps, Surgical knife.

### **9.5.8 Storage and Stability.**

Wax not in use are kept at room temperature. Wax in use for embedding must be stored at 60°C.

### **9.5.9 Safety**

- i. Decontaminate working surfaces before and after embedding.
- ii. Adhere to safety precautions as stated in the Safety manual.
- iii. All personal protective equipment (PPE) must be worn when performing this procedure.
- iv. All samples must be regarded as potentially infectious.
- v. Refer to National infection prevention and control Guidelines for health waste management and safety practice.
- vi. Do not use kit beyond the expiration date which appears on the package label or device in a damaged pouch.

### **9.5.10 Calibration**

Calibrate the thermometer of the embedding module and cryo module.

### **9.5.11 Quality Control.**

Not applicable

### **9.5.12 Procedure Steps**

- i. Operation of Embedding machine.
- ii. Check level of paraffin wax in the chamber if refilling is needed (should be at least ½ chambers full).
- iii. Switch on the CRYO part by pressing the 'status on screen and then press cooling options on screen.
- iv. Open one cassette and inspect the tissue size then choose mold of appropriate size.
- v. Take the selected mold from the transfer tray of the right chamber and place it on a hot plate under the Paraffin wax dispenser.
- vi. Dispense a little molten paraffin wax in the mold by gently and briefly pressing the fingerplate.
- vii. Pick the tissue by using a forceps and place it at center of the mold with molten paraffin wax and hold it with forceps briefly on the cold spot. Observe proper orientation.
- viii. Immediately place the original tissue's cassette on the mold and refill the mold with paraffin wax to the top. Do not place on hot plate.
- ix. Transfer to the mold with cassette to the cooling chamber to solidify.
- x. Remove the Paraffin wax block from the mold.
- xi. Remove the excess wax around the block.
- xii. Re-label if the labeling on the cassette is faint.
- xiii. Send for section cutting.

### **9.5.13 Biological References Intervals**

Not applicable

### **9.5.14 Interpretation and Report of Results.**

Not applicable

### **9.5.15 Limitation of the Procedure and Sources of Error.**

Unlabeled tissue cassettes. Caring over the small tissue particles from one tissue to another. Large tissue

### **9.5.16 Performance Characteristics**

Not applicable

### **9.5.17 Supportive Documents.**

Results Management Procedure, Safety Manual, Sample Collection Manual

### **9.5.18 References**

Bancroft JD, Gamble M. Theory and Practice of Histological Techniques.

Churchill Livingstone; 5th ed. 2001.

## **9.6 PROCEDURE FOR TISSUE PROCESSING BY USING AUTOMATED PROCESSOR MACHINE**

### **9.6.1 Purpose**

This procedure provides instructions on how to perform tissue processing.

### **9.6.2 Scope**

This procedure is applicable during Tissue Processing Hospital Laboratory.

### **9.6.3 Responsibility**

The head of Unit Histopathology is responsible for ensuring the effective implementation and maintenance of this procedure.

### **9.6.4 Principle**

The dehydration of tissue is suitable for infiltration with wax which support tissue during section.

### **9.6.5 Sample requirement**

Excisional /incisional biopsy, tissue curetting, Chips and needle biopsy, Cytological samples

### **9.6.6 Equipment**

Automated Tissue Processor

### **9.6.7 Materials**

10% Formal saline, 70% Ethanol, 95% Ethanol, Absolute Ethanol, Xylene, Paraffin wax, Gloves, Mask, Goggles

### **9.6.8 Storage and stability**

Alcohol, xylene, alcohol in use kept in the machine at room temperature.

Paraffin Wax in use is kept at 60 °c

Paraffin wax not in use kept at room temperature in solid state.

Tissue Samples are kept in room temperature while fixed in containers.

### **9.6.9 Safety**

All samples should be considered as potentially infectious.

Xylene is carcinogenic; always wear gloves, mask and goggles when handling it.

Follow the national IPC guideline.

#### **9.6.10 Calibration**

Not applicable

#### **9.6.11 Quality control**

Not applicable

#### **9.6.12 Procedure Steps**

- i. Make sure that the machine is switched on
- ii. Open retort and insert the trough containing sample in the machine.
- iii. Close the retort/lids
- iv. To begin processing, press 'IMMEDIATE TO START OR DELAYED START' From the main menu.
- v. A bottle connection check is automatically performed whenever a delay start or an
- vi. Immediate start is selected. If the start mode was selected as immediate the message
- vii. Line will indicate the instrument is in process and the program will begin to time Down.
- viii. Drain retort. Once the processing run is complete, the retort will remain filled with
- ix. Reagents from the last station for which time was entered in the program (generally
- x. This will be paraffin). The retort must be drained before sample basket has been Removed.
- xi. If machine is not running, refer to operational manual.

#### **9.6.13 Biological reference intervals**

Not applicable

#### **9.6.14 Interpretation and result reporting**

Not applicable

#### **9.6.15 Limitations of the procedure and sources of error**

Poor fixation

Calisified tissue hinder the tissue processing

Use of expired reagent

#### **9.6.16 Performance Characteristics**

Refer method verification report

### **9.6.17 Supporting Document**

Quality manual, sample collection manual, sample retention schedule.

### **9.6.18 References**

Thermos Scientific Excelsior AS Operator Guide A82310100 Issue 9

Vacuum Infiltration Processor operating manual. (Sakura Fine Technical Co., Ltd, Tokyo, 103-0023, Japan, 2001 Sakura Finetek U.S.A. In.



## **9.7 PROCEDURE FOR PERFORMING PAPANICOLAU'S STAIN**

### **9.7.1 Purpose**

This procedure provides instructions for how to stain Cytological slides for microscopic examination with Papanicolau's staining technique

### **9.7.2 Scope**

This procedure is applicable during Papanicolau's staining at Hospital Laboratory.

### **9.7.3 Responsibility**

Qualified and trained Medical Laboratory Technologists and scientists are responsible for doing this test procedure.

The head of Histopathology is responsible for ensuring the effective implementation and maintenance of this procedure.

### **9.7.4 Principle.**

In the first staining step the nuclei are stained by basic dye Hematoxylin solution due to presence of nucleic acid (DNA and RNA). Nuclei are stained blue, dark violet to black. The second staining step is cytoplasm staining by orange G staining solution, especially for demonstration of mature and keratinized cells. The target structures are stained orange in different intensities. In the third staining step the so-called polychromatic solution is used, a mixture of eosin and light green SF. The polychromatic solution is used for demonstration of differentiation of squamous cells mature and immature cells matured appear pink and immature appear green.

### **9.7.5 Sample requirements.**

Well fixed in 95% alcohol ethanol slide smear with cytological sample atleast for 30 minutes.

### **9.7.6 Equipment**

Light Microscope and Timer.

### **9.7.7 Materials.**

#### **Reagents and consumables**

Xylene, Harris Hematoxylin, 1% Acid in 70% Ethyl Alcohol, Orange G-6 solution, Eosin Azure 36, Absolute ethyl alcohol, Ethanol 70%, 80% and 95% and DPX.

#### **Consumable**

Containers for Reagents and Solutions, Slide staining rack, Cover slips.

### **9.7.8 Storage and stability.**

- All reagent stored at well monitored room temperature.
- Must be used before expiration date from manufacture.
- Cytological smear not allowed to dry pre-staining and during mounting.

### **9.7.9 Safety**

- All personal protective equipment (PPE) must be worn when performing this procedure.
- All samples must be regarded as potentially infectious.
- Refer to National infection prevention and control Guidelines for health waste management and safety practice.
- Xylene is carcinogenic; always wear gloves, mask and goggles when handling it.

### **9.7.10 Calibration**

Timer should be calibrated according to the schedule.

### **9.7.11 Quality Control**

Not applicable

### **9.7.12 Procedure**

- Remove smear from fixative.
- Rinse smear in descending grade of alcohol (95%,80% and 70% ethanol) ten dips each.
- Rinse in tap water ten dips .
- Stain in Harris hematoxylin for 10 minutes.
- Rinse in running tap water ten dips.
- Differentiate in 1% acid in 70% ethyl alcohol: 1 dip
- Rinse in running tap water.
- Blue in running tap water for 10 minutes.
- Rinse smear in ascending grades of alcohol (70%, 80% and 95% ethyl alcohol) ten dips each
- Stain in Orange G-6 for 3 minutes.
- Rinse in 2 changes of 95% ethyl alcohol: 10dips.
- Stain in EA- 36 solution for 3minutes.
- Rinse in 95% alcohol 2 changes 10 dips each.
- Complete dehydration in 2 changes of absolute ethyl alcohol: 10 dips each.
- Clear alcohol in Xylene 2 changes ten dips each.
- Mount the slide with DPX and cover slip.
- Label slides accordingly.

### **9.7.13 Biological reference intervals**

Not applicable

### **9.7.14 Interpretation and reporting of results.**

Under microscope the following features will appear as:

Nuclear –blue

Cytoplasm-green to red depend on maturity of cell.

Spermatozoa-blue black

Sex chromatin body-blue black

Kelatinized cell-orange.

#### **9.7.15 Limitation of the Procedure and Sources of Error**

Poor preparation of reagents, Poor smear fixation, Over / under differentiation

#### **9.7.16 Performance Characteristics**

Refer the method verification report

#### **9.7.17 Supportive Documents.**

Results Management Procedure, Safety Manual, Sample Collection Manual, Sample Management Procedure and sample retention schedule.

#### **9.7.18 References**

Bancroft JD, Gamble M. Theory and Practice of Histological Techniques, 5th ed. Churchill Livingstone; 2001.

Clayden (fifth edition) Practical section cutting and staining.

MOH (1994) -Laboratory manual for histopathology, V.Y Mgya, C. Lembeli, et al

A manual of Histology staining methods of the Armed Forces Institute of Pathology: Lee G.Luna; 3rd edition

Carleton (5th edition) Histological technique

## **9.8 PROCEDURE FOR PERFORMING HEMATOXYLIN AND EOSIN STAIN**

### **9.8.1 Purpose.**

To provide instructions during haematoxylin and eosin staining procedure.

### **9.8.2 Scope.**

This procedure is applicable during manual Hematoxylin and eosin staining in the laboratory

### **9.8.3 Responsibility.**

Qualified and trained Medical Laboratory Technologists and scientists are responsible for doing this test procedure.

The head of Histopathology unit is responsible for ensuring the effective implementation and maintenance of this procedure

### **9.8.4 Principle**

Tissue structures contain groups of cells that are made up of the nucleus and cytoplasm. The nuclei of the tissues which are acidic in nature due to their nucleic acid content i.e. DNA and RNA have the affinity for basic dyes. Haematin is the oxidation product of Hematoxylin. When used in conjunction with a mordant (e.g. Potassium alum which is included in Hematoxylin solution) it will provide a stable link called dye lake which binds to the acid phosphate groups of DNA and RNA and stain the nuclei into blue color. The cytoplasm on the other hand is basic in nature and will have an affinity for the acidic dyes. Eosin which is acidic in nature is the most suitable stain to combine with alum- Hematoxylin for demonstration of cytoplasm architecture by staining it red/shades of pink. It is vital to use the correct concentration of reagents such as 1% HCL acid in 70% ethyl alcohol for differentiating the stains of RNA in cytoplasm.

### **9.8.5 Sample Requirements**

Histological tissue slide.

### **9.8.6 Equipment**

Light microscope, Timer

### **9.8.7 Material**

#### **Reagents**

Reagent, Xylene, Harris Hematoxylin, 1% Acid in 70% ethyl Alcohol, Tap Water Substitute, 1% aqueous Eosin Staining Solution, Absolute ethanol and 95%, DPX. (Mountant).

## **Consumables**

Containers for Reagents and Solutions, Gloves, Laboratory coat, Cover slips, Frosted Slides and Staining rack

### **9.8.8 Storage and stability.**

- All reagents must be stored at room temperature in closed container.
- Stained slide must be kept at least ten years at room temperature after making diagnosis.
- Unprocessed sample kept fixed at room temperature following retention schedule.
- Quality control slides kept at room temperature for ten years.

### **9.8.9 Safety**

- All samples should be considered as potentially infectious.
- Xylene is carcinogenic; always wear gloves, mask and goggles when handling it.
- Alcohol has the effect on veins system when inhaled.
- Haematoxylin contains mercuric oxide which is carcinogenic.

### **9.8.10 Calibration**

Calibrate timer will be done based on calibration schedule.

### **9.8.11 Quality Control**

- Any intestinal biopsy is good for control of H and E stain and to be done after preparation of new reagent.
- The control sample is obtained in house.

### **9.8.12 Procedure Steps**

- i. Dewax sections in xylene for 5 mins.
- ii. Dewax section in xylene only ten dips.
- iii. Clear the section in two changes of 100% ethanol ten dips each.
- iv. Hydrate the section in two changes of 95% ethanol ten dips each.
- v. Hydrate in tap running water for ten dips.
- vi. Stain in Harris hematoxylin for 10 minutes.
- vii. Rinse in running tap water
- viii. Differentiate in 1% acid alcohol for one dip.
- ix. Rinse in tap water
- x. Blue the sections in tap water for 10 minutes.
- xi. Counter stain in 1% or 0.5% aqueous eosin for 3 minutes.
- xii. Rinse in tap water.
- xiii. Dehydrate the sections in 95% ethanol for ten dips.
- xiv. Complete the dehydration in two changes of 100% ethanol ten dips each.
- xv. Clear in two changes of xylene (3 minutes in each)

xvi. Mount with DPX or mounting machine.

#### **9.8.13 Biological reference intervals.**

Not applicable

#### **9.8.14 Results interpretation**

- Nuclei - Will stain blue color
- Cytoplasm and intercellular substances - shades of pink and red
- Cells with much RNA or acid mucopolysaccharide - Purplish

#### **Critical values**

Not applicable

#### **9.8.15 Limitation of the Procedure and Sources of Error**

- Poor preparation of reagents.
- Poor storage of stains and reagent.
- Poor quality of tissue sections

#### **9.8.16 Performance Characteristics**

Refer method verification report

#### **9.8.17 Supportive Documents.**

- Results Management Procedure.
- Safety Manual.
- Sample Collection Manual.
- Sample Management Procedure

#### **9.8.18 References**

- i. Bancroft JD, Gamble M. Theory and Practice of Histological Techniques. 5th ed. Churchill Livingstone; 2001.
- ii. Clayden (fifth edition) Practical section cutting and staining.
- iii. Carleton (5th edition) Histological techniques
- iv. MOH (1994) -Laboratory manual for histopathology, V.Y Mgaya, C. Lembeli, et al
- v. A manual of Histology staining methods of the Armed Forces Institute of Pathology: Lee G. Luna; 3rd edition.

## **9.9 PROCEDURE FOR PERFORMING PHOSPHOTUNGSTIC ACID STAIN**

### **9.9.1 Purpose**

To demonstrate muscle cross-striations and fibrin. Cross-striations are a diagnostic feature of Rhabdomyosarcomas, or tumors arising from striated muscle. Nemalin rods present in some skeletal muscle diseases may also be demonstrated by this method

### **9.9.2 Scope**

This procedure is applicable during staining with PTAH at Hospital Laboratory.

### **9.9.3 Responsibility**

Qualified and trained Medical Laboratory Technicians, technologists and scientist are responsible for doing this test procedure.

The head of Unit Histopathology is responsible for ensuring the effective implementation and competency assessment for this procedure.

### **9.9.4 Principle.**

The amount of Phosphotungstic acid in the staining solution is far greater than the amount of hematein (20:1), and it is believed that tungsten binds all available hematein to give a blue –colored lake. This metal-hematein lake stains selected tissue components blue, while the phosphotungstic acid is thought to stain the red-brown components. This stain has been referred to as polychrome stain because one solution gives two major colors. The components colored red-brown will lose this color with water or prolonged alcohol washes, and dehydration of the section following staining therefore must be rapid.

### **9.9.5 Sample Requirements.**

Histological unstained tissue slide.

### **9.9.6 Equipment.**

Light Microscope, Timer

### **9.9.7 Materials.**

#### **Reagents**

Phosphotungstic acid Hematoxylin (PTAH) solution, Xylene, Absolute ethanol, Gram's iodine, 5% sodium thiosulfate, 0.25% potassium permanganate, 5% oxalic acid, 95% ethanol

#### **Consumables**

Coupling jar, Whatman's filter paper, Cover slips, Staining rack

### **9.9.8 Storage and stability.**

- Tissue block and tissue slide stored at well monitored room temperature for ten years.
- All reagent must be used before manufacture expiration date and are stored at room temperature
- Positive control and negative control are stored following sample storage.

### **9.9.9 Safety**

- i. Decontaminate working surfaces twice daily, in the morning and afternoon
- ii. Adhere to safety precautions as stated in the Safety manual
- iii. All personal protective equipment (PPE) must be worn when performing this procedure.
- iv. All samples must be regarded as potentially infectious.
- v. Refer to National infection prevention and control Guidelines for health waste management and safety practice.
- vi. Avoid any contact between hands and eyes and nose during sample collection and testing
- vii. Xylene is carcinogenic; always wear gloves, mask and goggles when handling it.
- viii. The test device should be stored at 2 -30<sup>0</sup> C. And the test should be performed at room temperature.

### **9.9.10 Calibration**

Calibrate timer basing on the schedule

### **9.9.11 Quality Control**

Positive control - Skeletal or cardiac muscle tissue section.

Negative control -Normal Lymph node (PTAH negative tissue section)

Negative and positive control performed before sample testing, control can be obtained from EQA provider or in house known samples

### **9.9.12 Procedure**

- i. Dewax sections in two changes of xylene 5 minutes and ten dips respectively.
- ii. Clean the section in two changes of absolute alcohol for ten dips each.
- iii. Rinse in 95% alcohol ten dips.
- iv. Hydrate in tap water for ten dips.
- v. If sections are fixed with mercuric chloride containing fixatives then treat with Lugol's iodine for five minutes, wash and treat with 5% sodium thiosulphate for one minutes.
- vi. If formalin pigment present in tissue section then treat a section with 8.5% in saturated alcohol picric acid.
- vii. Rinse in tap water.



- viii. Place in Gram's iodine for 15 minutes.
- ix. Rinse in tap water.
- x. Place in 5% aqueous sodium thiosulfate for 3 minutes
- xi. Wash in tap water for 10 minutes.
- xii. Place in 0.25% potassium permanganate for 5 minutes.
- xiii. Rinse in tap water.
- xiv. Place in 5% oxalic acid for 1 minute.
- xv. Wash in running water for 10 minutes.
- xvi. Stain in PTAH solution for 16 hours at room temperature or 1 hour at 60C.
- xvii. Dehydrate rapidly through two changes of each of 95% and absolute ethanol.
- xviii. Clear in two changes of Xylene ten dips each.
- xix. mount with DPX or mounting machine.

#### **9.9.13 Biological references intervals.**

Not applicable

#### **9.9.14 Interpretation and reporting of results.**

Cross-striations –blue

Nuclei - blue

Collagen -red- brown

#### **9.9.15 Critical values**

Not applicable

#### **9.9.16 Limitation of the Procedure and Sources of Error**

Poor preparation of reagents.

Poor storage of stains.

Poor quality of tissue section

Poor tissue fixation.

#### **9.9.17 Performance Characteristics**

Refer method verification report

#### **9.9.18 Supportive Documents**

Results Management Procedure, Safety Manual, Sample Collection Manual and Sample Management Procedure.

#### **9.9.19 References**

- i. Bancroft JD, Gamble M. Theory and Practice of Histological Techniques.
- ii. Churchill Livingstone; 5th ed. 2001.
- iii. Clayden, Practical section cutting and staining. 5th ed
- iv. Carleton Histological techniques, 5th Ed.

## **9.10 PROCEDURE FOR PERFORMING PERIODIC ACID SCHIFF**

### **9.10.1 Purpose**

To demonstrate polysaccharides, neutral mucosubstances, and basement membranes.

### **9.10.2 Scope**

This procedure is applicable during staining Periodic acid Schiff at Hospital Laboratory.

### **9.10.3 Responsible staff**

Qualified and trained Medical Laboratory Technicians, technologists and scientists are responsible for doing this test procedure.

The head of Histopathology section is responsible for ensuring the effective implementation and competency assessment for this procedure.

### **9.10.4 Principle**

The reaction is based upon the fact that periodic acid will bring about oxidative cleavage of carbon to carbon bond in 1,2-glycols or the amino or alkaline derivatives, to form di-aldehydes. These aldehydes will react with Schiff's reagent which combines with the basic pararosaniline to form a magenta coloured compound.

### **9.10.5 Sample requirement**

Histological tissue sections.

### **9.10.6 Equipment**

Light microscope

Timer

### **9.10.7 Materials**

Reagents

1%Periodic Acid, Schiff Reagent, Xylene, DPX, Absolute alcohol, Distilled water, Harris Haematoxylin, 1% Acid in 70% Alcohol, Containers for Reagents and Solutions,

Consumable

Whatman's filter paper and Staining rack.

### **9.10.8 Storage and stability**

All Tissue slides are kept at room temperature

Reagents are kept at room temperature

#### **9.10.9 Special Safety Precautions**

All sample should be considered as potentially infectious

Xylene is carcinogenic; always wear gloves, mask and goggles when handling it.

#### **9.10.10 Calibration**

Timer is calibrated following the laboratory schedule

#### **9.10.11 Quality control**

Positive control-A section of kidney or Appendix

Negative control- PAS negative tissue. Control are obtained in house and are performed before patient samples being tested.

#### **9.10.12 Detailed procedures**

- i. Dewax sections and bring down to distilled water.
- ii. Put you slides, section upwards, on the staining rack.
- iii. Treat with 1% Periodic Acid solution for 5 minutes.
- iv. Wash well in three changes of distilled water.
- v. Cover tissue section with Schiff solution for 15 minutes.
- vi. Wash in running tap water for 10 minutes.
- vii. Stain nuclei with Harris Hematoxylin for 2 minutes.
- viii. Differentiate in 1% acid in 70% alcohol.
- ix. Blue in running tap water for 10 minutes.
- x. Dehydrate with 95% and absolute ethanol.
- xi. Clear in two changes of Xylene.
- xii. Mount with mounting machine.

#### **9.10.13 Biological reference intervals**

Not applicable

#### **9.10.14 Interpretation and Reporting results**

Neutral muco substances, basement membrane- seen as bright rose/ magenta

Reporting is not applicable

#### **9.10.15 Limitations of the procedure and sources of error**

Poor quality of slides

Poor preparation of stains

**9.10.16      *Performance Characteristics***

Refer method verification report

**9.10.17      *Supportive Documents***

Quality manual, sample collection manual, sample retention schedule **and** result management procedure

**9.10.18      *References***

Bancroft JD, Gamble M. Theory and Practice of Histological Techniques, 5th Ed. Churchill Livingstone; 2001.

## **9.11 PROCEDURE FOR PERFORMING PERL'S PRUSSIAN BLUE STAINING**

### **9.11.1 Purpose**

To detect ferric (Fe<sup>3+</sup>) iron in tissue. Ferric iron is normally found in small amount in the bone marrow and spleen. Abnormally large deposits may be found in hemochromatosis and hemosiderosis.

### **9.11.2 Scope**

This procedure is applicable during Perl's Prussian blue staining at Hospital Laboratory.

### **9.11.3 Responsibility**

The head of Histopathology section is responsible for ensuring the effective implementation and maintenance of this procedure.

### **9.11.4 Principle**

This method detects the ferric iron in loosely bound protein complexes. Iron that is strongly bound, as in haemoglobin will not react. In the Prussian blue reaction sections are treated with an acidic solution of Potassium Ferro cyanide and ferric iron present reacts to form an insoluble bright blue pigment called Prussian blue.

### **9.11.5 Sample requirement**

Histological tissue sections

### **9.11.6 Equipment**

Light microscope

Timer

### **9.11.7 Materials**

Reagents

2% potassium Ferro cyanide, 2% hydrochloric acid, Nuclear fast red, Xylene, DPX, Absolute alcohol, 95% alcohol, Containers for Reagents and Solutions, cover slips, staining rack, coupling jars, Graduated cylinders, Pipettes

### **9.11.8 Storage and stability**

Tissue slide kept at room temperature before being stained

Reagents are kept at room temperature

### **9.11.9 Safety**

All sample should be considered as potentially infectious

Xylene is carcinogenic; always wear gloves, mask and goggles when handling it.

#### **9.11.10 Calibration**

Calibration of timer will be done according to the schedule

#### **9.11.11 Quality control**

**Positive control- Section of Liver or Spleen**

**Negative control- Perl's Prussian blue negative tissue**

Quality Control is included every time the stain is performed.

#### **9.11.12 Procedures steps**

- i. Dewax section and bring down to distilled water
- ii. Place slides in a freshly prepared mixture of equal parts of 2% potassium ferrocyanide and 2% Hydrochloric acid ,stain for 10 minutes
- iii. Wash sections thoroughly in several changes of distilled water
- iv. Counter stain section in 1% nuclear fast red for 1 minute
- v. Wash in tap water for 1 minute
- vi. Dehydrate in two changes of 95% alcohol followed by two changes of absolute alcohol ten dips each.
- vii. Clear in two changes of xylene
- viii. Mount **with DPX/mounting machine and label the slides.**

#### **9.11.13 Biological reference intervals**

Not applicable

#### **9.11.14 Interpretation and reporting results**

Nuclei and hemofuchsin will stain Bright Red

Hemosiderin (Iron) will stain Blue

Background-blue

**Result reporting will be done by pathologists.**

#### **9.11.15 Limitations of the procedure and sources of error**

Poor tissue fixation

Poor quality of slide

Poor preparation of reagents

**9.11.16      *Performance Characteristics***

Refer method verification report

**9.11.17      *Supporting Document***

Results Management Procedure, Safety Manual, Sample Collection Manual.

**9.11.18      *References***

- i. Bancroft JD, Gamble M. Theory and Practice of Histological Techniques. 5th ed. Churchill Livingstone; 2001
- ii. Clayden E C, 5th ed Practical section cutting and staining
- iii. Drury RAB and Wallington EA, 5th ed Carleton's Histological technique
- iv. MOH (1994) Laboratory manual for Histopathology.
- v. Lee G Luna; Manual of Histologic staining methods of the Armed Forces Institute of Pathology; 3rd Ed.



## **9.12 PROCEDURE FOR ACID - FAST MYCOBACTERIUM IN TISSUE SECTION**

### **9.12.1 Purpose**

To detect the presence of acid- fast Mycobacterium in tissue section.

### **9.12.2 Scope**

This procedure is applicable during Ziehl-Neelsen staining in histopathology unit

### **9.12.3 Responsibility**

Qualified, trained and competent health laboratory practitioners are responsible for implementing this test procedure.

The head of Histopathology section is responsible for ensuring the effective implementation and maintenance of this procedure.

### **9.12.4 Principle**

The lipid capsule of the acid- fast organism takes up carbol-fuchsin and resists decolonization with dilute mineral acid. Carbol fuchsin is more soluble in lipids of the cell wall than in acid-alcohol, but is readily removed from bacteria that lack the wax capsule. Staining is enhanced by the phenol and the alcohol, and both of the chemicals also aid in dissolving the basic fuchsin. Alcoholic, rather than aqueous solutions of acid are used because more uniform decolonization is obtained with alcoholic solutions.

### **9.12.5 Sample Requirement**

Histological tissue sections

### **9.12.6 Equipment**

Light microscope, timer, hot plate

### **9.12.7 Materials**

Reagents	Consumables
Carbol- Fuchsin, 2% Methylene Blue, Xylene, DPX, 1% Acid in 70% Alcohol, Absolute ethanol, 95% ethanol	Containers for Reagents and Solutions  Whitman's filter papers number, Cover slips, Staining rack, Spirit lamp

### **9.12.8 Storage and Stability**

Reagents should be stored at room temperature away from direct sunlight or as instructed by manufacturer

Store slide films at room temperature as per sample retention schedule

### **9.12.9 Safety**

All samples should be considered as potentially infectious.

Xylene is carcinogenic; always wear gloves, mask and goggles when handling it.

### **9.12.10 Calibration**

Perform equipment calibration as scheduled

### **9.12.11 Quality Control**

Positive control - Known acid-fast mycobacteria positive Tissue section/smear.

Negative control -Known acid-fast mycobacteria negative Tissue section /smear

QC should be included every time ZN stain is performed

### **9.12.12 Procedural Steps**

- i. Deparaffinize the sections and bring down to distilled water.
- ii. Put slides, section upwards, on the staining rack.
- iii. Flood the slide section with carbol- fuchsin.
- iv. Warm until steam rises. (Do not boil) and leave for 10 minutes.
- v. Wash well in distilled water.
- vi. Differentiate in 1% acid in 70% alcohol until the color stop from the section.
- vii. Wash well in distilled water.
- viii. Counter stain with 0.2% methylene blue for 1 minute.
- ix. Bloat dry with whatma's filter paper.
- x. Transfer to two of each change of 95% and absolute alcohol.
- xi. Clear in two changes of Xylene.
- xii. Add a drop of DPX on the stained slide and cover slip it or use mounting machine.

### **9.12.13 Biological Reference Intervals**

Not applicable

### **9.12.14 Interpretation and Reporting of Results**

#### **Interpretation of results**

- Acid fast bacilli –Red
- Background - Pale blue
- Erythrocytes - Yellowish orange

### **9.12.15 Limitations of the Procedure and Source of Errors**

- i. Poor preparation of reagents
- ii. Poor storage of stains.

iii. Poor quality of tissue sections

**9.12.16      *Performance Characteristics***

Refer to method verification report of this procedure

**9.12.17      *Supporting Documents***

Sample Collection Manual.

**9.12.18      *References***

Bancroft JD, Gamble M. Theory and Practice of Histological Techniques, Churchill Livingstone; 5th ed. 2001.

Practical section cutting and staining. Clayden 5th Ed, Carleton (fifth edition) Histological techniques.

## **9.13 VERHOFF'S ELASTIC STAIN**

### **9.13.1 Purpose**

To demonstrate elastic fibers in tissue sections. It can also be used to demonstrate normal elastic as in the identification of veins and arteries, and to determine whether or not the blood vessels have been invaded by tumor.

### **9.13.2 Scope**

This procedure is applicable during Verhoff's elastic stain at Histopathology unit

### **9.13.3 Responsibility**

Qualified, trained and competent Health laboratory practitioner are responsible for doing this test procedure. The head of Histopathology section is responsible for ensuring the effective implementation and competency assessment for this procedure.

### **9.13.4 Principle**

The tissue is over stained with a soluble lake of hematoxylin-ferric chloride. Both ferric chloride and iodine serves as mordant, but they also have an oxidizing function that assists in converting hematoxylin to hematein. The mechanism of dye binding is probably by formation of hydrogen bonds, but the exact chemical groups reacting with the hematoxylin have not been identified. This method requires that the section be over stained and then differentiated, so it is regressive. Differentiation is accomplished by using excess mordant, or ferric chloride, to break the tissue-mordant dye complex. The dye will be attracted to the larger amount of mordant in the differentiating solution and will be removed from tissue. The elastic tissue has the strongest affinity for the iron-hematoxylin complex and will retain the dye longer than the other tissue elements. This allows other elements to be decolorized and the elastic fibers to remain stained. Sodium thiosulfate is used to remove excess iodine. Van gieson's is used as the counter stain.

### **9.13.5 SAMPLE REQUIREMENT**

Histological tissue sections

### **9.13.6 Equipment**

Microscope, timer, hotplate

### **9.13.7 Materials**

Reagents	Consumables
Verhoff's elastic stain (ferric chloride +lugol's iodine +hematoxylin) 2% ferric chloride, Sodium thiosulfate, Van gieson's solution, Xylene, Ethanol absolute, 95% ethanol	Containers for Reagents and Solutions  Whitman's filter papers, Cover slips, Staining rack.

### **9.13.8 Storage and Stability**

- Reagents should be stored at room temperature away from direct sunlight or as instructed by manufacturer
- Store slide films at room temperature as per sample retention schedule

### **9.13.9 Safety**

All sample should be considered as potentially infectious

Xylene is carcinogenic; always wear gloves, mask and goggles when handling it.

### **9.13.10 Calibration**

Perform equipment calibration as per Calibration Schedule

### **9.13.11 Quality Control**

Positive control - cross section of aorta

Negative control – verhoff's negative tissue

### **9.13.12 Procedural Steps**

- i. Deparaffinize sections and hydrate to distilled water
- ii. Place sections in Verhoff's elastic stain for 1 minute.
- iii. Differentiate sections microscopically in 2% ferric chloride until the elastic fibers are distinct and the background is colorless to light gray.
- iv. Rinse sections in distilled water.
- v. Place sections in sodium thiosulfate for 1 minute.
- vi. Wash in running tap water for 5 minutes.
- vii. Counter stain in van Gieson's stain for 1 minute.
- viii. Differentiate in 95% alcohol.
- ix. Dehydrate in three changes of absolute alcohol
- x. Clear in two changes of Xylene.
- xi. Add a drop of DPX on the stained slide and cover slip it

### **9.13.13 Biological Reference Intervals**

Not Applicable

### **9.13.14 Interpretation and Reporting of Results**

#### **1.1 Interpretation of results**

- Elastic fibers - Blue- black to black
- Nuclei - blue to black
- Collagen - Red
- Other tissue elements - Yellow

### **9.13.15      *Limitations of The Procedure and Source of Error***

- Poor quality of slides
- Poor preparation of stains

### **9.13.16      *Performance Characteristics***

Method verification of this procedure should be done and that the report should be referred to verify compliance to this requirement. of this procedure

### **9.13.17      *Supporting Documents***

- Quality Manual
- Safety Manual.
- Sample Collection Manual.

### **9.13.18      *References***

- xii. Bancroft JD, Gamble M. Theory and Practice of Histological Techniques. xiii. 5th ed. Churchill Livingstone; 2001.
- xiv. Clayden E C, 5th ed Practical section cutting and staining
- xv. Drury RAB and Wallington EA, 5th ed Carleton's Histological technique
- xvi. MOH (1994) Laboratory manual for Histopathology
- xvii. Freida L Carson; Histotechnology A self-Instructional Text.
- xviii. Lee G Luna; Manual of Histologic staining methods of the Armed Forces Institute of Pathology; 3rd Ed.

## **9.14 VAN GIESON'S PICRIC ACID-ACID FUCHSIN STAIN**

### **9.14.1 Purpose**

To demonstrate collagen in tissue sections.

### **9.14.2 Scope**

This procedure is applicable during Van Gieson's Picric Acid-Acid Fuchsin stain at histopathology unit.

### **9.14.3 Responsibility**

Qualified, trained and competent Health laboratory practitioner are responsible for doing this test procedure.

The head of Histopathology section is responsible for ensuring the effective implementation and competency assessment for this procedure.

### **9.14.4 Principle**

In a strong acidic solution, collagen is selectively stained by acidic fuchsin, an acid aniline dye. Picric acid provides the acidic pH necessary and also acts as a stain for muscle and cytoplasm. The low pH is very important, as selective staining of collagen will not occur at a higher pH levels. The addition of 0.25 mL of hydrochloric acid to 100 mL of van Gieson's solution will sharpen the differentiation between collagen and muscle. Saturated Picric acid solutions are important in the preparation of the stain, again for selective staining of collagen. If picric acid solution is not saturated, collagen may stain pale pink to orange, and collagen, cytoplasm, and muscle may all stain the same color.

### **9.14.5 Sample Requirement**

Histological tissue sections

### **9.14.6 Materials**

Reagents	Consumables
Xylene, Absolute ethanol, 95% alcohol, Wegert's Iron hematoxylin, Picric acid, Van gieson's stain.	Containers for Reagents and Solutions Whitman's filter papers, Cover slips, Staining rack.

### **9.14.7 Equipment**

Light microscope, Timer and hot plate

### **9.14.8 Storage and Stability**

- Reagents should be stored at room temperature away from direct sunlight or as instructed by manufacturer

- Store slide films at room temperature as per sample retention schedule

#### **9.14.9 Safety**

- All sample should be considered as potentially infectious
- Xylenes is carcinogenic, always wear gloves, mask and goggles when handling it.

#### **9.14.10 Calibration**

Perform equipment calibration as per calibration schedule

#### **9.14.11 Quality Control**

- Positive control - uterus, small intestine or appendix tissue sections.
- Negative control - Van gieson's negative tissue section.

#### **9.14.12 Procedural Steps**

- Deparaffinize sections and hydrate to distilled water.
- Stain sections with Weigert's iron hematoxylin for 10 to 20 minutes. Sections should be over stained, as they will be slightly decolorized by picric acid.
- Wash in running water for 10 minutes.
- Stain sections in van Gieson's stain for 5 minutes.
- Place slides in 95% ethanol.
- Dehydrate in absolute ethanol, clear with xylene and mount with DPX or mounting machine.

#### **9.14.13 Biological Reference Intervals**

Not applicable

#### **9.14.14 Interpretation and Reporting of Results**

##### **Interpretation of results**

Nuclei - Black, Collagen - Brilliant red, Muscle and cytoplasm – Yellow.

##### **Reporting of results**

Not Applicable

#### **9.14.15 Limitations of the Procedure and Source of Errors**

- Poor tissue fixation
- Poor quality of slides
- Poor preparation of stains

#### **9.14.16 Performance Characteristics**



Method verification of this procedure should be done and that the report should be referred to verify compliance to this requirement. of this procedure

**9.14.17      *Supporting Document***

Safety Manual, Sample Collection Manual.

**9.14.18      *References***

Bancroft JD, Gamble M. Theory and Practice of Histological Techniques.

Freida L Carson; Histotechnology A self-Instructional Text.

Lee G Luna; Manual of Histologic staining methods of the Armed Forces Institute of Pathology; 3rd Ed

## **9.15 PROCEDURE FOR PERFORMING IMMUNOHISTOCHEMISTRY.**

### **9.15.1 Purpose**

To provide instructions during manual immunohistochemistry staining.

### **9.15.2 Scope**

This procedure is applicable during immunohistochemistry staining at Hospital Laboratory.

### **9.15.3 Responsibility**

Qualified and trained Medical Laboratory Technologists and scientists are responsible for doing this test procedure.

The head of Histopathology unit is responsible for ensuring the effective implementation and competency assessment for this procedure.

### **9.15.4 Principle**

This method for detecting antigens or haptens in cells of a tissue section by exploiting the principle of antibodies binding specifically to antigens in biological tissues. The antibody-antigen complexes can be visualized in different manners under light microscopy.

### **9.15.5 Sample Requirements**

Histological tissue sections(tissue slide).

### **9.15.6 Equipment**

Microtome, Light microscope, Timer, Pressure cooker, Electrical hot plate and Humidity chamber.

### **9.15.7 Materials**

#### **Reagents.**

Antigen Retrieval solution (citrate buffer) 10% working solution, Tris Buffer Saline (wash buffer) 10% working solution, Peroxidase blocking solution 3%, Different types of primary antibodies, Horse Reddish Peroxidase (HRP), DAB, Substrate buffer, Harris hematoxylin, 1% HCl in &70% alcohol, DPX.

#### **Consumables**

Containers for Reagents and Solutions, Gloves, Micropipettes, Micropipettes tips, Pasturpipette, Laboratory coat, Cover slips and PAP pen.

### **9.15.8 Storage and Stability.**

- Different types of primary antibodies, Antigen Retrieval solution (citrate buffer) stock, Tris Buffer Saline (wash buffer) stock, Peroxidase blocking solution 3%, Horse Reddish Peroxidase (HRP), DAB and Substrate buffer must kept at 2°C-8 °C until expiration date.
- All working solution must be used per single day.
- Tissue block, stained slide, haematoxyline and acid alcohol must kept at well monitored room temperature.

#### **9.15.9 Safety**

- Decontaminate working surfaces twice daily, in the morning and afternoon.
- Adhere to safety precautions as stated in the Safety manual.
- All personal protective equipment (PPE) must be worn when performing this procedure.
- All samples must be regarded as potentially infectious.
- Refer to National infection prevention and control Guidelines for health waste management and safety practice.
- Do not use kit beyond the expiration date which appears on the package label or device in a damaged pouch.
- The test should be performed at room temperature.
- Hydrogen peroxide causes burns, and is highly oxidizing, always wear gloves and face protection when handling.
- DAB is known CARCINOGENIC handle with EXTREME CARE, always wear gloves, clean up spills immediately; neutralize and discard down sink.
- Pressure cooker causes severe burns, wear gloves and face mask when handling boiling liquids.

#### **9.15.10 Calibration**

Calibration should be done to all equipments as per schedule

#### **9.15.11 Quality Control**

- Positive control sections for the test antigen under analysis. Same primary antibodies have specific organs with specific antigens. Eg (CD 20, CD 45 the tonsil can be used as positive control).
- A negative control (no primary antibody applied to the test section) is also run to assess background staining from endogenous peroxidase or cross reaction from the detection kit.
- The control tissue sections are cut at the same time as the test sections and if possible placed on the same slide.
- The control is placed on the bottom half of the slide; this minimizes wash time disparities between test section and control.

#### **9.15.12 Procedure Steps**

- Cut on charged slides and bake for 30 minutes on hot plate with 60°C.
- Dewax sections in two changes of xylene 5 minutes and ten dips respectively.
- Clean the section in two changes of absolute alcohol for ten dips each.

- iv. Rinse in 95% alcohol ten dips
- v. Hydrate in tap water for ten dips.
- vi. Ring sections with PAP pen and add drops of peroxidase blocking solution to cover the section, leave it for 15 minutes.
- vii. Place slides in tap water for 1 minutes.
- viii. Heat antigen retrieval solution or citrate buffer in pressure Cooker until it starts boiling.
- ix. Place slides in antigen retrieval solution in pressure cooker and close the lid.
- x. Time for 20 minutes at full pressure or two sound from pressure cooker.
- xi. Remove slides from pressure cooker and place in water. Do not allow slides to dry from this step onwards.
- xii. Add Tris Buffer Saline (TBS) for 3 minutes.
- xiii. Drain off TBS and cover sections with primary antibody at appropriate dilution and incubate in humidity chamber for 60 minutes.
- xiv. Wash gently with TBS on slide for 5 minutes.
- xv. Drain off TBS from slides and cover sections with drops of Horse reddish Peroxidase (HRP) and incubate in humidity chamber for 30 minutes, the reagent should be at room temperature before use.
- xvi. Wash gently for 5 minutes with TBS ( make up DAB reagent by adding one drop of DAB to 1 ml of substrate buffer).
- xvii. Drain TBS from slides and apply working DAB reagent to the sections and incubate in humidity chamber for 5 minutes.
- xviii. Wash slides well in tap running water.
- xix. Counterstain with hematoxylin for 2 minutes, dip in 1% acid alcohol 1 dips.
- xx. Blue in tap running water for 2 minutes.
- xxi. Dehydrate from 95% alcohol for ten dips
- xxii. Complete dehydration in two changes of absolute alcohol ten dips each.
- xxiii. clear in two changes of xylene for ten dips each.
- xxiv. mount with DPX.

#### **9.15.13      *Biological Reference Intervals***

Not applicable

#### **9.15.14      *Interpretation and Reporting of Results.***

Cell with antigen-antibody complex(cytoplasm or nuclear) - Brown ( intensity reflects amount of antigen present ).

Nuclear with no antigen-antibody complex counter stain - Blue.

#### **9.15.15      *Limitation of the Procedure and Sources of Error***

- i. Poor storage of primary antibody.
- ii. Too much heat can detruct the antgen mophology.
- iii. Over or underdilution of antibodies.
- iv. Poor washing of tissue slide can lead to background stain.
- v. Poor dewaxing of tissue slide can lead to background stain.
- vi. Drying of tissue slides can couse false negative results.

### **9.15.16      *Performance Characteristics***

Refer method verification report

### **9.15.17      *Supportive Documents***

Results Management Procedure, Safety Manual, Sample Collection Manual, Sample Management Procedure.

### **9.15.18      *References***

- i. Bancroft JD, Gamble M. Theory and Practice of Histological Techniques. 5th ed. Churchill Livingstone; 2001.
- ii. Clayden (fifth edition) Practical section cutting and staining.
- iii. Carleton (5th edition) Histological techniques.
- iv. MOH (1994) - Laboratory manual for histopathology, V.Y Mgaya, C. Lembeli, et al
- v. A manual of Histology staining methods of the Armed Forces Institute of Pathology: Lee G. Luna; 3rd edition.
- vi. George Lunn and Eric b. Sansoe (1991) the safe disposal of Diaminobenzidine.
- vii. Applied Occupational environment hygiene 6 (1).
- viii. Shia J, Klimstra DS et al. Value of immunohistochemical detection of DNA mismatches repair proteins in predicting germline mutation in hereditary colorectal neoplasm. AM J Surg Pathol 2005;29:96-104
- ix. Freida L. Carson: Histotechnology, A self-Instruction text

## Annex 1: List of Subject Matter Experts who developed these SOPs

No	NAME	TITILE	FACILITY
1.	Adam Mwakyoma	Laboratory Scientist	Kilimanjaro Christian Medical Centre (KCMC), Moshi
2.	Amedeus Mushi	Laboratory Scientist & Epidemiologist	HLPC, MoH, Dodoma
3.	Anjela Maufi	Laboratory Scientist	Kitete RRH, Tabora
4.	Antusa Massawe	Laboratory Scientist	Dunga H/C, Tanga
5.	Baraka Mathias	Laboratory Scientist	Maranatha Hospital, Mbeya
6.	Betrand Msemwa	Microbiology & Manyara	Catholic University of Health and Alliened Sciences (CUHAS), Mwanza
7.	Bezard Ngumbuchi	Quality Officer	PHLB, Dodoma
8.	Ceif Abdul	Quality Officer	NPHL, Dar es Salaam
9.	David Ocheng	Laboratory Expert/Consultant	Ilala, Dar es Salaam
10.	Desmond Kileo	ICTO	DHCTSU, MoH, Dodoma
11.	Dickson Charles Kakuntebe	Laboratory Scientist	Cardinal Rugambwa Hospital, Dar es Salaam
12.	Dominic Fwiling'afu	Registrar	PHLB, MoH, Dodoma
13.	Dr. Alex Magesa	DDS	DHCTSU, MoH, Dodoma
14.	Dr. Goodluck Tesha	Epidemiologist	Jhpiego, Dar es Salaam
15.	Dunstan Haule	Laboratory Quality Officer	NBTS-HQ, Dar es Salaam
16.	Edward Lushishi	Laboratory Technologist	Singida RRH, Singida
17.	Emmanuel Ndaki	Laboratory Scientist	NBTS Lake zone, Mwanza
18.	Eng. Gervas H. Swai	Biomedical Engineer	DHCTSU, MoH, Dodoma
19.	Eng. Suniva S. C. Haule	Head Health Care and Technical Services	DHCTSU, MoH, Dodoma
20.	Ezekiel Mng'ong'o	Laboratory Scientist	Maranatha Hospital, Mbeya
21.	Farhiya Mohamed	Laboratory Quality Officer	NBTS Eastern Zone, Dar es Salaam
22.	Ferdinand Matata	Head of Diagnostic Services	PO-RALG, Dodoma
23.	Frank Changala	Laboratory Scientist	NPHL, Dar es Salaam
24.	Dr Haji Hussein	Technical officer	ICAP, Dar es Salaam
25.	Frank Mushi	Laboratory Scientist	Manyara RRH, Manyara
26.	Frank Shemhande	Laboratory Quality Officer	SBNRH-Ndanda, Mtwara
27.	Godfrey Mahundi	Laboratory Manager	Dodoma MC Hospital
28.	Helman Mhangala	Deputy Laboratory Manager	NBTS Central Zone, Dodoma

29.	Ibrahim Mauki	Laboratory Scientist	NPHL, Dar es Salaam
30.	Idrissa Hassan	Laboratory Service Coordinator	PORALG, Dodoma
31.	Innocent A. Chinguile	Laboratory Scientist & Epidemiologist	Training, Dodoma MoH,
32.	Jackson Luvamunda	Quality Officer	Sinza HC, Dar es Salaam
33.	Jackson Zengo	Deputy National Laboratory Quality Officer	DHCTSU, Dodoma MoH,
34.	Jacob Lusekelo	National Laboratory Quality Officer	DHCTSU, Dodoma MoH,
35.	James Mziray	Laboratory Service Coordinator	PO-RALG, Dodoma
36.	Joakim Chacha	LS-HSEEP	DHCTSU, MoH, Dodoma
37.	Joyce Samson	Laboratory Quality Officer	Sekou-Toure RRH, Mwanza
38.	Kadogosa Saimon	Laboratory Technologist	Singida RRH, Singida
39.	Lanja Kahemela	Laboratory Quality Officer	MNH, Mloganzila, Dar es Salaam
40.	Maige Ngeleja	DSCMC	MoH, Dodoma
41.	Mary F. Mtui	Registrar	HLPC, MoH, Dodoma
42.	Mayala Lushina	Laboratory Quality Officer	MNH, Upanga, Dar es Salaam
43.	Michael Mazoya	Laboratory Scientist	NBTS, Dar es Salaam
44.	Mzelifa Daudi	Microbiologist	University of Dodoma (UDOM), Dodoma
45.	Pius R. Tarimo	Laboratory Scientist & Epidemiologist	Kilimanjaro Christian Medical University College (KCMUCo), Moshi
46.	Rajabu Muninge	Laboratory Scientist	Maranatha Hospital, Mbeya
47.	Rashid Nassoro	Laboratory Quality Officer	Morogoro RRH, Morogoro
48.	Reuben Abednego	Laboratory Scientist	NPHL, Dar es Salaam
49.	Reuben Lema	Deputy Laboratory Manager	Morogoro Morogoro RRH,
50.	Reuben S. Mkala	Ag. Head of Laboratory Service	DHCTSU, Dodoma MoH,
51.	Richard Kinyaha	Laboratory Scientist	Kibong'oto IDH, Kilimanjaro
52.	Robert Makala	Regional Laboratory Technologist (RLT)	RAS - Manyara
53.	Sabra Rashid	Laboratory Scientist	MoH, Unguja-Zanzibar
54.	Said Lunemhya	Laboratory Scientist	Benjamin Mkapa ZRH, Dodoma
55.	Scolastica S. Manyama	Laboratory Quality Officer	Mirembe Hospital, Dodoma

56.	Susu Jeremiah Susu	Laboratory Quality Officer	Benjamin Mkapa ZRH, Dodoma
57.	Tamaly Lutufyo	Laboratory Manager	CCBRT, Dar es Salaam
58.	Ulfat Rahim	Laboratory Technologist	TMJ, Dar es Salaam
59.	William S Mollel	Laboratory Technologist	MOLLEL LABORATORY, Dodoma
60.	Yahya Mnung'a	MeLSAT-President	MeLSAT, Dar es Salaam
61.	Yohana Shirima	Laboratory Technologist	NBTS Northern zone, Moshi
62.	Yulitha Barnabas	Laboratory Manager	Dodoma RRH, Dodoma
63.	Zacharia Omary	Laboratory Manager	Sekou-Toure RRH, Mwanza

## Annex 2: Biological Reference Intervals for Full Blood Count

Parameter	Reference Range					
	Adult		Infants		Children	SI Unit
	Males	Females	Birth	1 month	1 year	
WBC	4.00 - 10.0	4.0 - 10	10 - 26	5.0 - 9.0	6.0 - 16.0	$\times 10^3 / \mu\text{L}$
NEU	40 - 80	40 - 80	40 - 80	40 - 80	40 - 80	%
LYM	20 - 40	20 - 40	20 - 40	20 - 40	20 - 40	%
MON	2 - 10	2 - 10	2 - 10	2 - 10	2 - 10	%
EOS	1 - 6	1 - 6	1 - 6	1 - 6	1 - 6	%
BASO	<1 - 2	<1 - 2	<1 - 2	<1 - 2	<1 - 2	%
RBC	4.5 - 5.5	3.8 - 4.8	5.0 - 7.0	3.0 - 5.4	3.9 - 5.1	$\times 10^6 / \mu\text{L}$
HGB	13.0 - 17.0	12.0 - 15.0	14.0 - 22.0	11.5 - 16.5	11.1 - 14.1	g/dL
MCV	83.0 - 99.0	83.0 - 99.0	100 - 120	92 - 116	72 - 84	fL
MCH	27.0 - 32.0	27.0 - 32.0	31.0 - 37.0	30.0 - 36	25.0 - 29.0	Pg
MCHC	31.5 - 34.5	31.5 - 34.5	30.0 - 36.0	29.0 - 37.0	32.0 - 36.0	g/dl
Hct	40 - 50	36 - 46	45 - 75	33 - 53	30 - 38	%
RDW						
PLT	150 - 410	150 - 410	100 - 450	200 - 500	200 - 550	$\times 10^3 / \mu\text{L}$
MPV						



### Annex 3: Biological Reference Intervals for Coagulation Profile

TEST	RANGE	SI UNIT
Prothrombin Time	9.40 - 12.50	Sec
Activated Prothrombin Time	25.40 – 36.90	Sec
Fibrinogen	2.20 – 2.80	g/l
Factor V	0.62 -1.39	IU
Factor VII	0.50 -1.29	IU
Factor VIII	0.50 -1.50	IU
Factor IX	0.65 -1.50	IU
Free protein S (male)	74.10 - 145.10	%
Free protein S (female)	54.70 - 123.70	%
Protein S activity	63.50 - 149.00	%
Protein C may be less in neonates, infants and increase in adolescence	70.00 – 140.00	%
Plaminogen (activity)	80.20 - 132.50	%
Plamin inhibitor	98.00 – 122.00	%
Homocysteine	4.30 - 11.10	µmol/L
D-dimmer	≤ 232	ng/ml
von will brand factor ristocetin cofactor activity (blood group O)	480 - 201.90	%
Von Will brand Factor ricostein factor activity (blood A+B+AB)	60.80 - 239.80	%

#### Annex 4: Biological Reference Intervals for Urine Biochemistry

<b>Parameter</b>	<b>Abbreviation</b>	<b>Biological Reference Intervals</b>
Urobilinogen	URO	Normal
Glucose	GLU	Negative
Bilirubin	BIL	Negative
Ketones	KET	Negative
Specific gravity	S.G	1.003-1.029
Occult blood	BLD	Negative
Ph	Ph	4.5 - 7.8
Protein	PRO	Negative
Nitrite	NIT	Negative
Leukocytes	LEU	Negative

## Annex 5: Biological Reference Intervals for Clinical Chemistry and Immunoassays

Test Name	Normal range	SI Unit
Parameter/Analyte	Sub category	
<b>Alanine aminotransferase (ALT)</b>	0 - 55	U/L
<b>Albumin</b>	35 – 50	g/l
<b>Alkaline Phosphate</b>	Male 15-125	U/L
	Female 15-125	U/L
	Male child 0 - 500	U/L
	Female Child 0 - 500	U/L
	Children	U/L
	Aged 1 day <250	U/L
	Aged 2 -5 days <231	U/L
	Aged 6 days – 6 months <449	U/L
	Aged 7months – 1 year <462	U/L
	Aged 1-3years <281	U/L
	Aged 4– 6years <269	U/L
	Aged 7 – 12 years <300	U/L
	Aged 13 – 17 years (M) <390	U/L
	Aged 13 – 17 years (F) <187	U/L
<b>Aspartate Aminotransferase</b>	5 - 34	U/L
<b>Bilirubin – Direct</b>	0 – 8.6	µmol/L
<b>Bilirubin – Total</b>	3.4 - 20.5 General	µmol/l
<b>Total Protein</b>	64 - 83	g/l
<b>Gamma Glutamyl Transferase</b>	Male 12- 64	U/L
	Female 9-36	U/L
	Male child 9-36	U/L
	Female child 9-36	U/L
<b>CSF protein</b>	0-4.3 lumbar fluid	g/L
<b>CSF glucose</b>	One third of Glucose	g/L
<b>Asciti Protein</b>	60-80	g/L
<b>Ascitic Glucose</b>	70 - 100	mg/dL
<b>Creatinine</b>	Adult Male 63.6-110.5	µmol/L
	Adult Female 50.4 – 98.1	µmol/L
	Male child 27 - 88	µmol/L
	Female child 27-88	µmol/L
<b>Blood Urea Nitrogen (BUN)</b>	Male 3.2- 7.4	µmol/L
	Female 2.5-6.7	µmol/L
	Male child 3.2-7.4	µmol/L
	Female Child 2.5- 6.7	µmol/L
<b>Cholesterol Total</b>	< 5.2	mmol/L
<b>HDL - Cholesterol</b>	1.04 – 1.55	mmol/L
<b>LDL – Cholesterol</b>	0 - 3.34	mmolL

Test Name	Normal range	SI Unit
Triglycerides	0 - 1.69	mmol/L
Sodium ( Na )	136 – 145	mmol/L
Potassium ( K )	3.5 – 5.1	mmol/L
Chloride (Cl )	98 - 107	mmol/L
Amylase Total	25- 125	U/L
Creatine Kinase ( CK )	Male 30 – 200	U/L
	Female 29- 168	U/L
	Male child 30 – 200	U/L
	Female child 29-168	U/L
Lactate dehydrogenase (LDH)	125 - 220	IU/L
Lipase	13- 60	U/L
Calcium	Male 2.1 – 2.55	mmol/L
	Famale 2.1-2.55	mmol/L
	Male child 2.2 – 2.7	mmol/L
	Female child 2.2 – 2.7	mmol/L
Glucose	3.3 - 6.1	mmol/L
Iron	Male 5.5 – 25.8	µmol/L
	Female 4.5 - 25.8	µmol/L
	Male child 5.5 – 25.8	µmol/L
	Female child 4.5 – 25.8	µmol/L
% Saturation (Iron saturation)	20 - 50	%
Uric Acid	Male 0.21 - 0.42	mmol/L
	Female 0.15 - 0.35	mmol/L
	Male child 0.21 - 0.42	mmol/L
	Female child 0.15 - 0.35	mmol/L
Phosphorus	0.74 - 1.52	mmol/L
Sodium 24hrs Urine	27 - 287	mmol/24 hours
Potassium 24hrs Urine	25 - 125	mmol/24hrs
Transferrin	Male 1.74 - 3.64	g/L
	Female 1.8 - 3.82	g/L
	Male child 1.86 – 3.88	g/L
	Female child 1.86 - 3.88	g/L
Alpha Feto Protein	0.0 - 1.09	ng/ml
High Sensitive Troponin	13.8-17.5 Female	pg/ml
	28.9-39.2 Male	pg/ml
Vitamin B12	187-883	pg/ml
Ferritin	10 - 250	ng/ml
Folate	3.72 - 50.4	ng/ml
PSA	0.0 - 4.0	ng/ml
TSH	0.49 - 4.67	IU/ml
T4	0.47 - 4.67	ng/L

Test Name	Normal range	SI Unit
T <sub>3</sub>	1.45 - 3.48	pg/ml
CK-MB	0.0 - 6	%
Tacrolimus	3 - 20	ng/ml
BNP	0-142	pg/ml
Cyclosporine	30.0-1500	ng/ml
CEA	0-5	ng/ml
CA-125	0-35	IU/mL
B-HCG	Less than 5 for non pregnant	mIU/mL
	25 for early pregnancy	mIU/mL
Vitamin D	0 - 160	ng/ml
Immunoglobulin G	5.40-18-22 Male	g/l
	5.52-16.31 Female	g/l
Immunoglobulin E	1-12 months <15	IU/mL
	1-5 years <60	IU/mL
	6-9 years <90	IU/mL
	10-15 years <200	IU/mL
	Adults <100	IU/mL
Immunoglobulin A	Male 63 - 645	mg/dl
	Female 65 - 517	mg/dl
	Male child 21- 291	mg/dl
	Female child 21 - 281	mg/dl
Immunoglobulin M	Male 0.22-2.40	g/l
	Female	g/l
	0.33-2.93	g/l
	Either 0.22-2.93	g/l
D - Dimer	0 .0 - 198	ng/L
CRP	0.0-5.0	mg/L
Estradiol	Follicular phase 21-251	pg/ML
	Midcycle phase 38-649	pg/ML
	Lueal phase 21-312	pg/ML
	Postmenopausal female 10-28	pg/ML
	Male 11-44	pg/ML
Prolactin	Male	ng/ml
	3.46-19.40	ng/ml
	Female 5.18-26.53	ng/ml
Testosterone	Male 4.94-32.01	nmol/L
	Female 0.38-1.97	nmol/L
Progesteron	Follicular phase 0.1-0.3	ng/ml
	Luteal phase 1.2-15.9	ng/ml
	Postmenopausal 0.1-0.2	ng/ml
	First trimester 2.8-147.3	ng/ml
	Second trimester 22.5-95.3	ng/ml

<b>Test Name</b>	<b>Normal range</b>	<b>SI Unit</b>
	Third trimester 27.9-242.5	ng/ml
	Male 0.1-0.2	ng/ml
<b>LH</b>	Male 1.14-8.75	ng/ml
	Follicular phase 2.39-6.60	ng/ml
	Midcycle peak-9.06-74.24	ng/ml
	Luteal phase 0.909.33	ng/ml
	Postmenopausal	ng/ml
	10.39-64.57	ng/ml
<b>FSH</b>	Male 0.95-11.95	mlu/mL
	Follicular phase 3.03-8..08	mlu/mL
	Midcycle peak 2.55-16.69	mlu/mL
	Luteal phase 1.38-5.47	mlu/mL
	Postmenopausal	mlu/mL
	26.72-133.41	mlu/mL
<b>Magnesium</b>	Male 0.66 - 1.07	mmol/L
	Female 0.66 - 1.07	mmol/L
	Male child 0.70 - 0.86	mmol/L
	Female 0.70 - 0.86	mmol/L
<b>ADA</b>	0 - 15	U/L
<b>Glycated haemoglobin (HBA1C)</b>	4 - 6	%

## Annex 6: Critical/Panic Values Requiring Immediate Actions

Analyte	Less Than	Greater Than
Amylase	25 U/L	150 U/L
Chloride	85 mmol/L	115 mmol/L
CK	30 U/L	200 U/L
Creatinine	26 umol/L	120 umol/L
Glucose(fasting)	2.5 mmol/L	20.0 mmol/L
Potassium	2.5 mmol/L	6.0 mmol/L
Sodium	120 mmol/L	160 mmol/L
Bilirubin Total	3.4 umol/L	20.5 umol/L
Bilirubin Total for new Born	<b>Newborn</b> 24hours ≥ 1374 umol/L 48hours ≥ 2224 umol/L 84hours ≥ 2904 umol/L One week to one month ≥ 3424 umol/L	
Urea (BUN)	≤ 1.0mmol/L	≥ 54 mmol/L
HGB	< 5 mg/dl	> 20 g/dl
CD4	200 cells/μl	

## Annex 7: Charts of Biochemical Identifications of common Enterobacteriaceae and Enteric Organisms

Organism	MAC Reaction	TSI	Oxidase	H <sub>2</sub> S	Gas	Motility	Indole	Urea	Citrate	Haemolysis	Comment
<i>Serratia mercesens</i>	NLF	K/A or A/A	-	-	+	+	-	-	+	-	Red pigment at room temp on MHA
<i>Proteus mirabilis</i>	NLF	K/A	-	+	+	+	-	+	+(weak)	-	Grow with swarming xters on BA
<i>Proteus vulgaris</i>	NLF	A/A or K/A	-	+	+	+	+	+	+/-	-	Grow with swarming xters on BA
<i>Salmonella sp</i>	NLF	K/A	-	+	+	+	-	-	+	-	Citrate pos (non-typhoid salmonella)
<i>Salmonella typhi</i>	NLF	K/A	-	Wk+	+	+	-	-	-	-	Black ppt on SSA&XLD
<i>Shigella sonnei</i>	NLF	K/A	-	-	-	-	-	-	-	-	No black ppt on SSA/XLD
<i>Other Shigella sp</i>	NLF	K/A	-	-	-	-	-	-	-	-	
<i>Vibrio cholerae</i>	NLF	A/A	-	+	+	-	-	-	-	+	String test-positive
<i>Vibrio parahaemolyticus</i>	NLF	K/A	+	-	-	+	+	-	+	+	
<i>P.aeruginosa</i>	NLF	K/NC	+	-	-	+	-	+	+	+/-	Green pigmentation on MHA
<i>Acinetobacter spp</i>	NLF	NC	-	-	-	-	-	-	-	-	Coccoide rods
<i>Morganella morganii</i>	NLF	K/A	-	-	+	+	+	+	-	-	
<i>Providencia spp</i>	NLF	K/A	-	-	-	+	+	-	+	-	
<i>Yersinia enterocolitica</i>	NLF	K/A	-	-	-	+(25/-35°C)	+/-	+/-	-	-	
<i>Edwardsiella tarda</i>	NLF	K/A	-	+	+	+	+	-	-	-	
<i>E.coli</i>	LF	A/A	-	-	+	+	+	-	-	+/-	Grows with precipitate bile salt on MCA
<i>Enterobacter aerogenes</i>	LF	A/A	-	-	+	+	-	-	+	-	Often resistant to Ampicillin and cephalosporin



Organism	MAC Reaction	TSI	Oxidase	H <sub>2</sub> S	Gas	Motility	Indole	Urea	Citrate	Haemolysis	Comment
<i>Klebsiella pneumoniae</i>	LF	A/A	-	-	+	-	-	+	+	-	Grow with very mucoid colonies
<i>Klebsiella oxytoca</i>	LF	A/A	-	-	+	-	+	+	+	-	
<i>Citrobacter freundii</i>	Late LF	A/A K/A	or	-	+	+	+	-	+/-	+	-









**FOR FURTHER INFORMATION CONTACT:**

**PERMANENT SECRETARY**

**MINISTRY OF HEALTH,**

**MAGUFULI GOVERNMENT CITY, AFYA ROAD/STREET, MTUMBA,**

**PO Box 743,**

**40478 DODOMA, TANZANIA.**

**LANDLINE: +255 (0)26 232 3267**

**EMAIL: [ps@afya.go.tz](mailto:ps@afya.go.tz)**

**WEBSITE: [www.moh.go.tz](http://www.moh.go.tz)**

ISBN 978-9912-9833-2-8

